

# rEConnect

Colección24



rEConnect

# INDEX

ECOcero

07-18

Products

18-163

ECOWall



ECONordik



ECOceiling



ECOollections



ECOImagine



ECObooth



ECObasics



ECOdesign

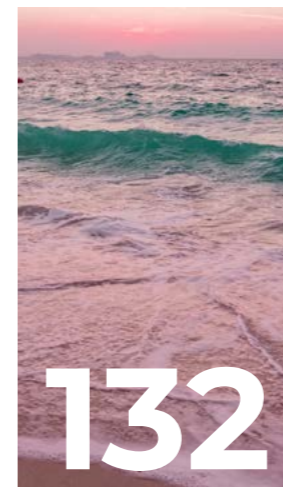
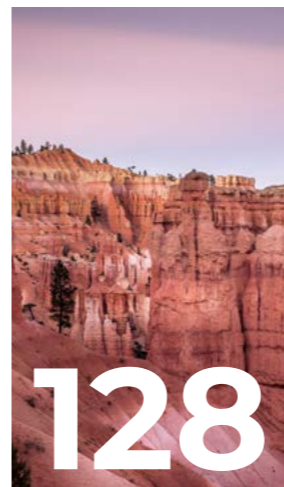
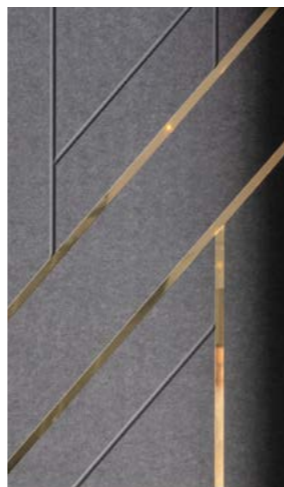
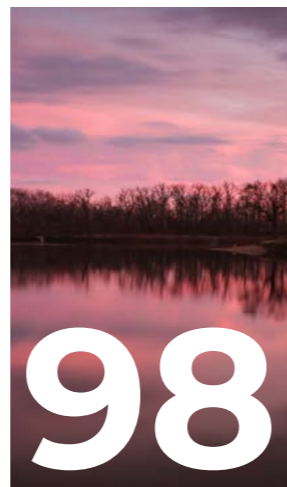
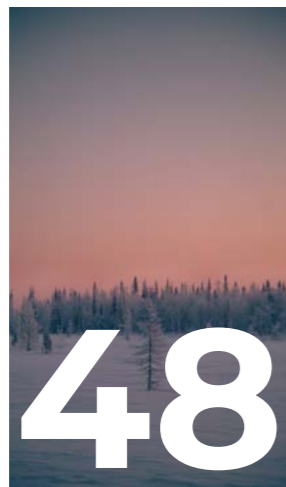

Technical specifications

164-213

Groovy P168  
Strata P169  
V-cut P170  
Volume P172

Emotion P174  
Meet P178  
Classic/Curve/Colour P180  
Seaqual P182

Flap P184  
Code P186  
Circular P188  
Quadrilateral P190

Baffle P191  
Cloud P192  
Aline P193  
Lumomesh P194

Puzzle P196  
Breeze P197  
Colibri P198  
Textures/Print P199

OTOGreen Wall P200  
OTOGreen Planter P202  
Quiet P204  
Sweet home P206

Square P208  
Circle P209  
Rectangle P210

Colours P211 | Anchors and accessories P212

**ECOWall**

**Groovy by Alejandra Pombo** | Product **P24** | Technical specifications **P168**  
**Strata by Erico Navazo** | Product **P26** | Technical specifications **P169**  
**V-cut** | Product **P28** | Technical specifications **P170**  
**Volume** | Product **P34** | Technical specifications **P172**  
**Emotion** | Product **P42** | Technical specifications **P174**

**ECOnordik**

**Meet by Erico Navazo** | Product **P52** | Technical specifications **P178**  
**Classic** | Product **P54** | Technical specifications **P180**  
**Curve** | Product **P58** | Technical specifications **P180**  
**Colour** | Product **P60** | Technical specifications **P180**  
**Seaqual** | Product **P64** | Technical specifications **P182**

**ECOceiling**

**Flap by Rafa Ortega** | Product **P70** | Technical specifications **P184**  
**Code by Rafa Ortega** | Product **P72** | Technical specifications **P186**  
**Circular by Rafa Ortega** | Product **P76** | Technical specifications **P188**  
**Quadrilateral by Open Book** | Product **P78** | Technical specifications **P190**  
**Baffle** | Product **P82** | Technical specifications **P191**  
**Cloud** | Product **P88** | Technical specifications **P192**  
**Aline** | Product **P94** | Technical specifications **P193**

**ECOollections**

**Lumomesh by The Room Studio** | Product **P102** | Technical specifications **P194**  
**Puzzle by Masquespacio** | Product **P104** | Technical specifications **P196**  
**Breeze by Noé Prades** | Product **P106** | Technical specifications **P197**  
**Colibri by Noé Prades** | Product **P106** | Technical specifications **P198**  
**Textures by Welcome Design** | Product **P108** | Technical specifications **P199**  
**OTOgreen Wall by Green Area** | Product **P110** | Technical specifications **P200**  
**OTOgreen planter by Green Area** | Product **P112** | Technical specifications **P202**  
**Quiet by Rafa Ortega** | Product **P114** | Technical specifications **P204**

**ECOImagine**

**Print** | Product **P120** | Technical specifications **P199**  
**Custom** | Product **P122**

**ECObooth**

**Sweet Home** | Product **P130** | Technical specifications **P206**

**ECObasics**

**Square** | Product **P136** | Technical specifications **P208**  
**Circle** | Product **P138** | Technical specifications **P209**  
**Rectangle** | Product **P140** | Technical specifications **P210**

**ECOart**

**OPTICAL ILLUSION by Masquespacio** | Interview **P144** | Product **P146**  
**QUIBBLE by Alejandra Pombo** | Interview **P148** | Product **P150**  
**MIRAGE by The Room Studio** | Interview **P152** | Product **P154**  
**WAVES by Noe Prades** | Interview **P156** | Product **P158**  
**OVER by Erico Navazo** | Interview **P160** | Product **P162**

# AWARDS



ARCHIPRODUCTS AWARDS WINNER SUSTAINABILITY



SOLUCIÓN SOSTENIBLE IX EDICION PREMIOS INTERIORES



2023 EMPRESA FINALISTA EN PREMIOS NAN

**interihotel**

PREMIO AL MEJOR  
DISEÑO DE STAND

2023

PREMIO AL MEJOR DISEÑO DE STAND

# ECO cero | Acoustic design.

ECOcerro redefines acoustics, merging design with sustainability. Our acoustic panels, created in Alicante, breathe new life into plastics, recycling millions of bottles. With a presence in 20 countries and 2,000 projects, we prioritize comfort and aesthetics, expanding globally with a steadfast commitment to quality and innovation.

We focus not only on acoustic solutions but also on combating climate change, adopting ecological practices and renewable energies, while maintaining a powerful social responsibility, collaborating directly with communities and social projects.

ECOcerro redefine la acústica, fusionando diseño con sostenibilidad. Nuestros paneles acústicos, creados en Alicante, dan nueva vida a los plásticos, reciclando millones de botellas. Con presencia en 20 países y 2000 proyectos, priorizamos el confort y la estética, extendiéndonos globalmente con un compromiso firme con la calidad y la innovación.

Nos enfocamos no solo en soluciones acústicas, sino también en combatir el cambio climático, adoptando prácticas ecológicas y energías renovables, mientras mantenemos una poderosa responsabilidad social, colaborando directamente con comunidades y proyectos sociales.



## Design Diseño

Design and innovation are the cornerstones of our essence. We collaborate with leading brands and some of the most prestigious designers globally. Furthermore, our partnership with the University of Alicante in research opens up uncharted horizons in the acoustic realm, allowing for unprecedented customization and adaptation.



El diseño y la innovación son los pilares de nuestra esencia. Trabajamos con marcas líderes y algunos de los diseñadores más prestigiosos a nivel internacional. Así mismo, Nuestra colaboración con la Universidad de Alicante en investigación abre horizontes inexplorados en el ámbito acústico, permitiendo una adaptación y personalización sin precedentes.

## Sustainability Sostenibilidad

Our commitment to the environment is reflected in each panel we create. We transform 75 bottles per square meter into unique acoustic design pieces, reconciling the fight against plastic pollution with the demand for distinct design, and steadily advancing towards carbon neutrality.



Nuestro compromiso con el medio ambiente se refleja en cada panel creado. Transformamos 75 botellas por m<sup>2</sup> en piezas únicas de diseño acústico, conciliando la lucha contra la contaminación plástica con la demanda de un diseño único y avanzando con paso firme hacia la neutralidad de carbono.

## Inspiration Inspiración

Each acoustic panel we design is more than an aesthetic enhancement; it's a recycled plastic bottle transformed with purpose. Innovation and sustainability come together, creating inspiring environments that benefit both people and the planet.



ECOzero is born upon the shimmering coasts of Alicante, merging acoustic design with sustainability. ECOzero nace sobre las brillantes costas de Alicante, fusionando diseño acústico con sostenibilidad.

Cada panel acústico que diseñamos es más que una mejora estética; es una botella plástica reciclada transformada con propósito. Innovación y sostenibilidad se unen, creando entornos inspiradores que benefician tanto a las personas como al planeta.

## Creativity Creatividad

At ECOcero, we design acoustic spaces. Our creativity lies in crafting high-end sound-absorbing panels, merging exclusivity with ecological responsibility.



En ECOcero diseñamos espacios acústicos. Nuestra creatividad radica en la creación de paneles fonoabsorbentes de alta gama, fusionando la exclusividad y la responsabilidad ecológica.

## Responsibility Responsabilidad

Awareness and Consciousness. Our vision goes beyond the confines of design and delves into people's needs. From Kenya to Ukraine, we collaborate with various non-profit organizations to make a positive difference in the world, providing solutions and support to the most vulnerable communities.



Conciencia y consciencia. Nuestra visión trasciende los límites del diseño y se adentra en las necesidades de las personas. Desde Kenia hasta Ucrania, colaboramos con múltiples organizaciones sin ánimo de lucro para marcar una diferencia positiva en el mundo, ofreciendo soluciones y apoyo a las comunidades más vulnerables.

## Well-being Bienestar

Our panels do more than absorb sound; they enhance well-being. Made from recycled plastic, they epitomize cutting-edge design focused on environmental comfort and acoustic health. They cultivate balanced environments that elevate the quality of life, while supporting the planet's health—a tangible commitment to sustainability and social responsibility reflected in every transformed space.



Nuestros paneles no solo absorben sonido, promueven bienestar. Confeccionados con plástico reciclado, representan la vanguardia de un diseño que prioriza la comodidad ambiental y la salud acústica. Crean ambientes equilibrados que mejoran la calidad de vida, mientras apoyan la salud del planeta, un compromiso tangible con la sostenibilidad y la responsabilidad social que se refleja en cada espacio transformado.

## Comfort Confort

In crafting each panel, comfort is our guiding star. These are pieces built to deliver superior serenity, shaped from sustainable materials that cater to acoustic comfort while nurturing the environment. Thus, every space is transformed into a haven of calm, mirroring our pledge to a more sustainable and responsible future.

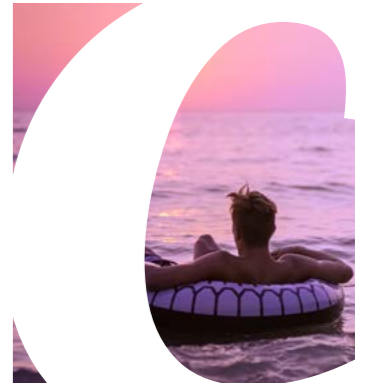

Al diseñar cada panel, pensamos en tu tranquilidad. Son piezas creadas para ofrecer un confort superior, construidas con materiales sostenibles que contribuyen a tu bienestar acústico y al cuidado del medio ambiente. Así, cada ambiente se convierte en un refugio de calma, reflejando nuestro compromiso con un futuro más sostenible y responsable.

In the crafting of every  
**1m<sup>2</sup>** of product,  
**75 plastic bottles** are recycled.

Para fabricar **1m<sup>2</sup>**  
de producto se reciclan  
**75 botellas de plástico.**

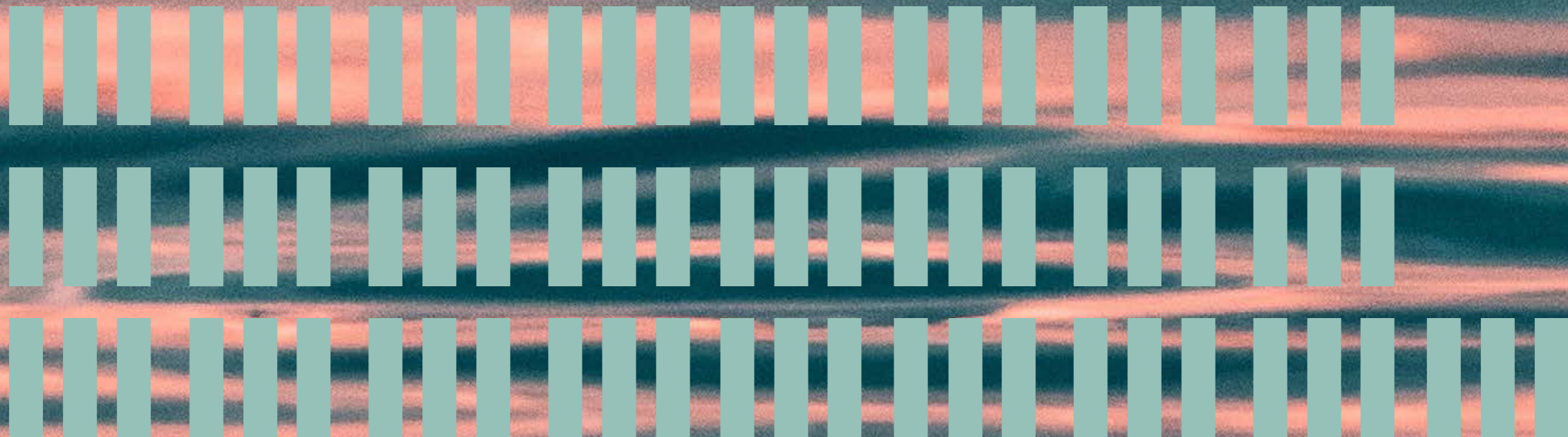





**At the Core of Serenity:** At ECOcero, we design acoustic spaces. Our creativity lies in crafting high-end sound-absorbing panels, merging exclusivity with ecological responsibility.

**Artificial and Emotional Intelligence:** At ECOcero's heart, two innovative forces intertwine: artificial intelligence and emotional intelligence, building a bridge between cutting-edge technology and a deep understanding of human and environmental needs. We are pioneers in designing acoustic panels that harmonize these two forms of intelligence, creating spaces that resonate with tranquility, empathy, and sustainability.

**Ecological Elegance:** Our commitment to the environment is reflected in each panel we create. We transform 75 bottles per square meter into unique acoustic design pieces, reconciling the fight against plastic pollution with the demand for distinct design, and steadily advancing towards carbon neutrality.

**Exclusive and Innovative Design:** Design and innovation are the cornerstones of our essence. We collaborate with leading brands and some of the most prestigious designers globally. Furthermore, our partnership with the University of Alicante in research opens up uncharted horizons in the acoustic realm, allowing for unprecedented customization and adaptation.

**Awareness and Consciousness:** Our vision goes beyond the confines of design and delves into people's needs. From Kenya to Ukraine, we collaborate with various non-profit organizations to make a positive difference in the world, providing solutions and support to the most vulnerable communities.

**En el Núcleo de la Serenidad:** En ECOcero diseñamos espacios acústicos. Nuestra creatividad radica en la creación de paneles fofoabsorbentes de alta gama, fusionando la exclusividad y la responsabilidad ecológica.

**Inteligencia artificial y emocional:** En el corazón de ECOcero se entretrejen dos fuerzas innovadoras: la inteligencia artificial y la inteligencia emocional, construyendo un puente entre la tecnología de vanguardia y la comprensión profunda de las necesidades humanas y medioambientales. Somos pioneros en diseñar paneles acústicos que armonizan estos dos tipos de inteligencia, creando espacios que resuenan con calma, empatía y sostenibilidad.

**Elegancia Ecológica:** Nuestro compromiso con el medio ambiente se refleja en cada panel creado. Transformamos 75 botellas por m<sup>2</sup> en piezas únicas de diseño acústico, conciliando la lucha contra la contaminación plástica con la demanda de un diseño único y avanzando con paso firme hacia la neutralidad de carbono.

**Diseño Exclusivo e Innovador:** El diseño y la innovación son los pilares de nuestra esencia. Trabajamos con marcas líderes y algunos de los diseñadores más prestigiosos a nivel internacional. Así mismo, Nuestra colaboración con la Universidad de Alicante en investigación abre horizontes inexplorados en el ámbito acústico, permitiendo una adaptación y personalización sin precedentes.

**Conciencia y consciencia:** Nuestra visión trasciende los límites del diseño y se adentra en las necesidades de las personas. Desde Kenia hasta Ucrania, colaboramos con múltiples organizaciones sin ánimo de lucro para marcar una diferencia positiva en el mundo, ofreciendo soluciones y apoyo a las comunidades más vulnerables.

# Products



## **ECOWall**

In nature, silence carries its own melody, a symphony of stillness that transcends words. And within that thread of tranquility, it beckons you to listen to the Earth's pulse.

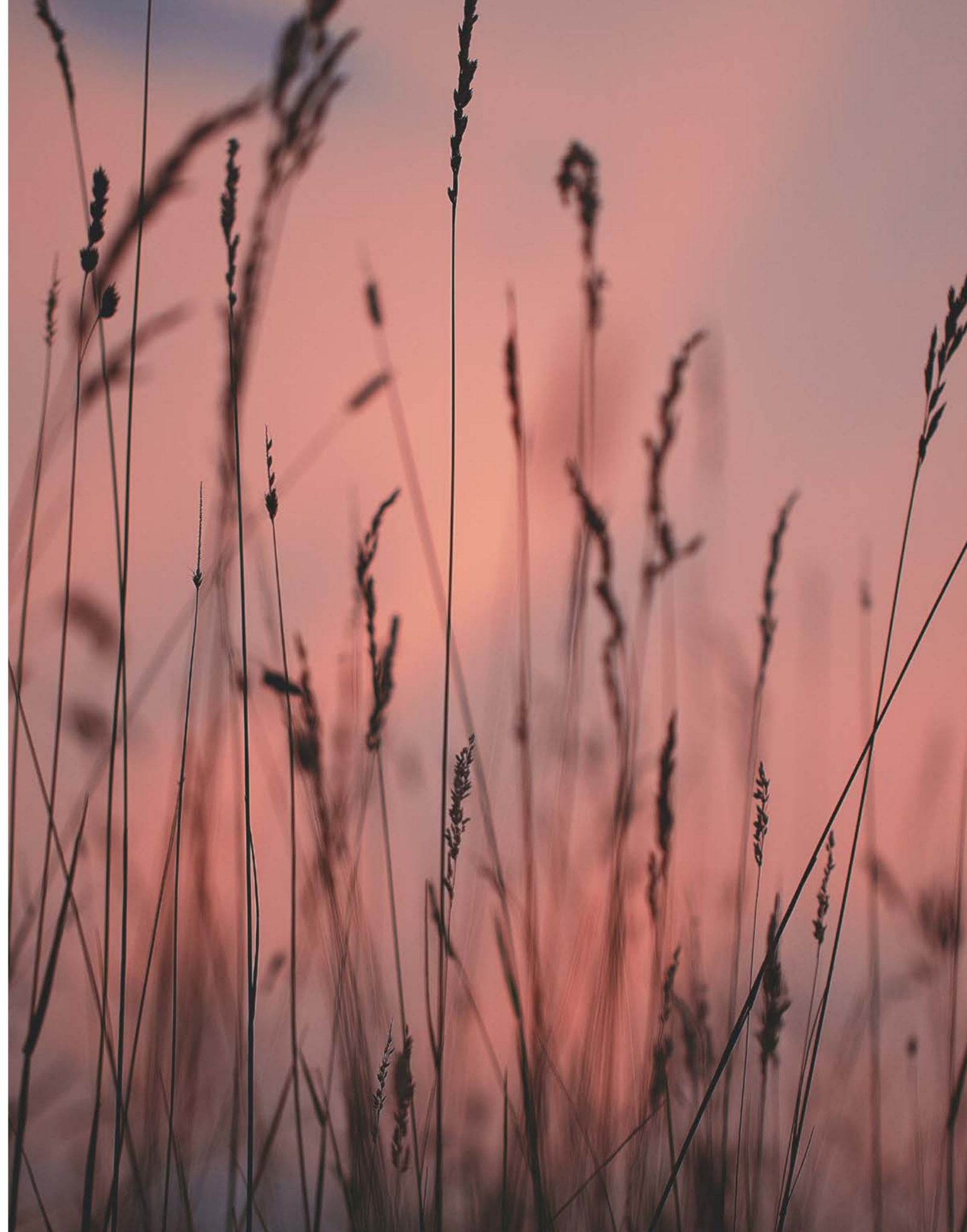



Innovative design blending aesthetics with sustainability. Colorful die-cut decorative panels provide outstanding sound insulation, reducing noise by up to 70%. Plus, each square meter is crafted by recycling 75 plastic bottles.

Un diseño innovador que combina estética y sostenibilidad. Los paneles decorativos pegados en paredes o techos ofrecen un excelente absorción acústica, reduciendo el ruido hasta un 70%. Además, cada metro cuadrado se fabrica reciclando 75 botellas de plástico.

Technical  
sheet — P168-177  
Colours — P211

# Groovy

The design of GROOVY is inspired by the postmodernist design of the 70s, a period marked by a shift in design towards something more authentic, personal, and chaotic, characterized by organic shapes and retro inspiration. It represents a reaction against the purified modernism of mid-century, in favor of “playful embellishment and radical experimentation with form.” Personal expression and individuality were the hallmarks of this era. It is characterized by a fun and asymmetrical pattern, bold and “explosive” colors.

El diseño de GROOVY está inspirado en el diseño pos-modernista de los años 70, donde se produjo un cambio en el diseño hacia algo más auténtico, más personal, más desordenado, con carácter, formas orgánicas e inspiración retro. Representa una reacción contra el modernismo purificado de mediados de siglo, a favor del “embellecimiento lúdico y la experimentación radical con la forma”. La expresión personal y la individualidad eran las señas de identidad de la época. Se caracteriza por ser un patrón divertido y asimétrico, colores atrevidos y “explosivos”.

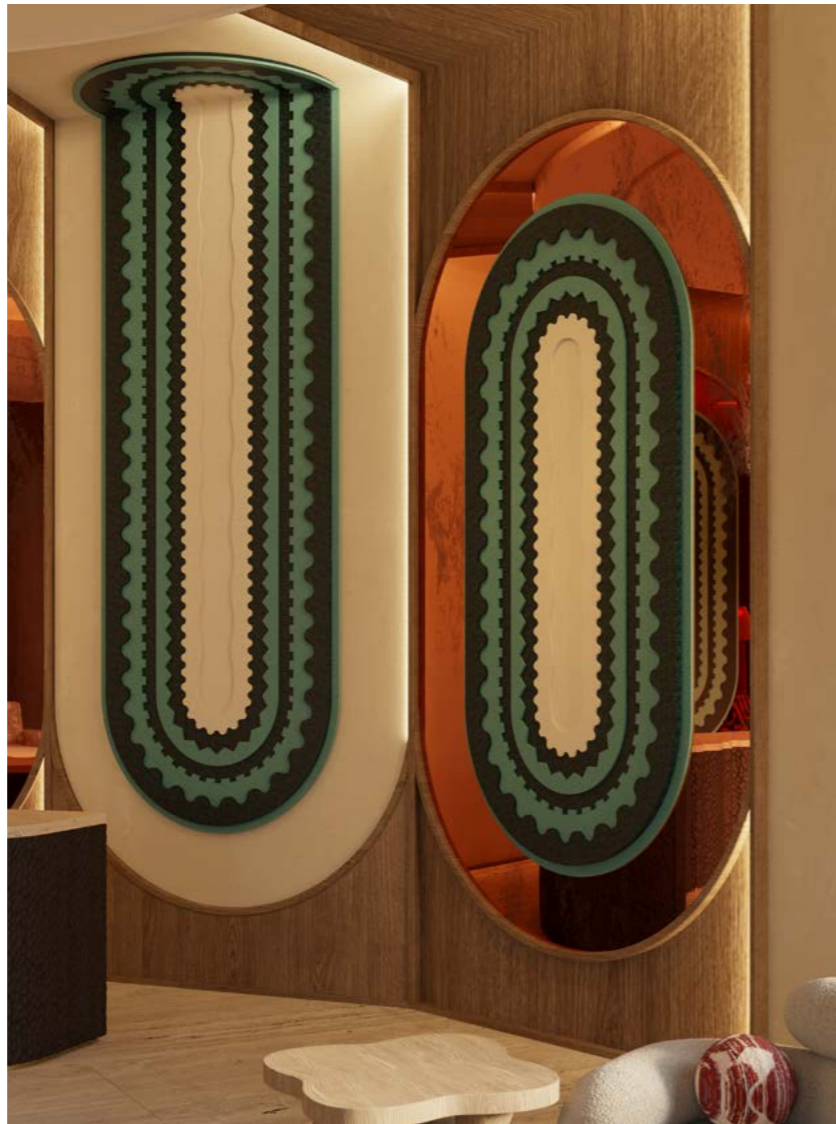

ECOWall  
Groovy  
**Technical**  
sheet — P168



## Alejandra Pombo

Alejandra Pombo stands out in the interior design world, creating spaces that capture the essence of comfort and functional beauty. Educated in the fine art of decor, her work speaks through natural textures, neutral colors, and meticulous lighting that enhances every nook. With a personalized approach, Alejandra transforms spaces into sanctuaries of peace and functionality, where each element is thoughtfully placed to enrich life quality. Her designs, often marked by open spaces and clean lines, reflect a contemporary aesthetic that pays homage to elegant simplicity and innovation.

Alejandra Pombo se destaca en el mundo del interiorismo, diseñando espacios que capturan la esencia de la comodidad y la belleza funcional. Educada en las finas artes de la decoración, su trabajo habla a través de texturas naturales, colores neutros y una iluminación meticulosa que realza cada rincón. Con un enfoque personalizado, Alejandra convierte los espacios en santuarios de paz y funcionalidad, donde cada elemento está pensado para mejorar la calidad de vida. Sus diseños, a menudo caracterizados por espacios abiertos y líneas limpias, reflejan una estética contemporánea que rinde homenaje a la simplicidad elegante y a la innovación.

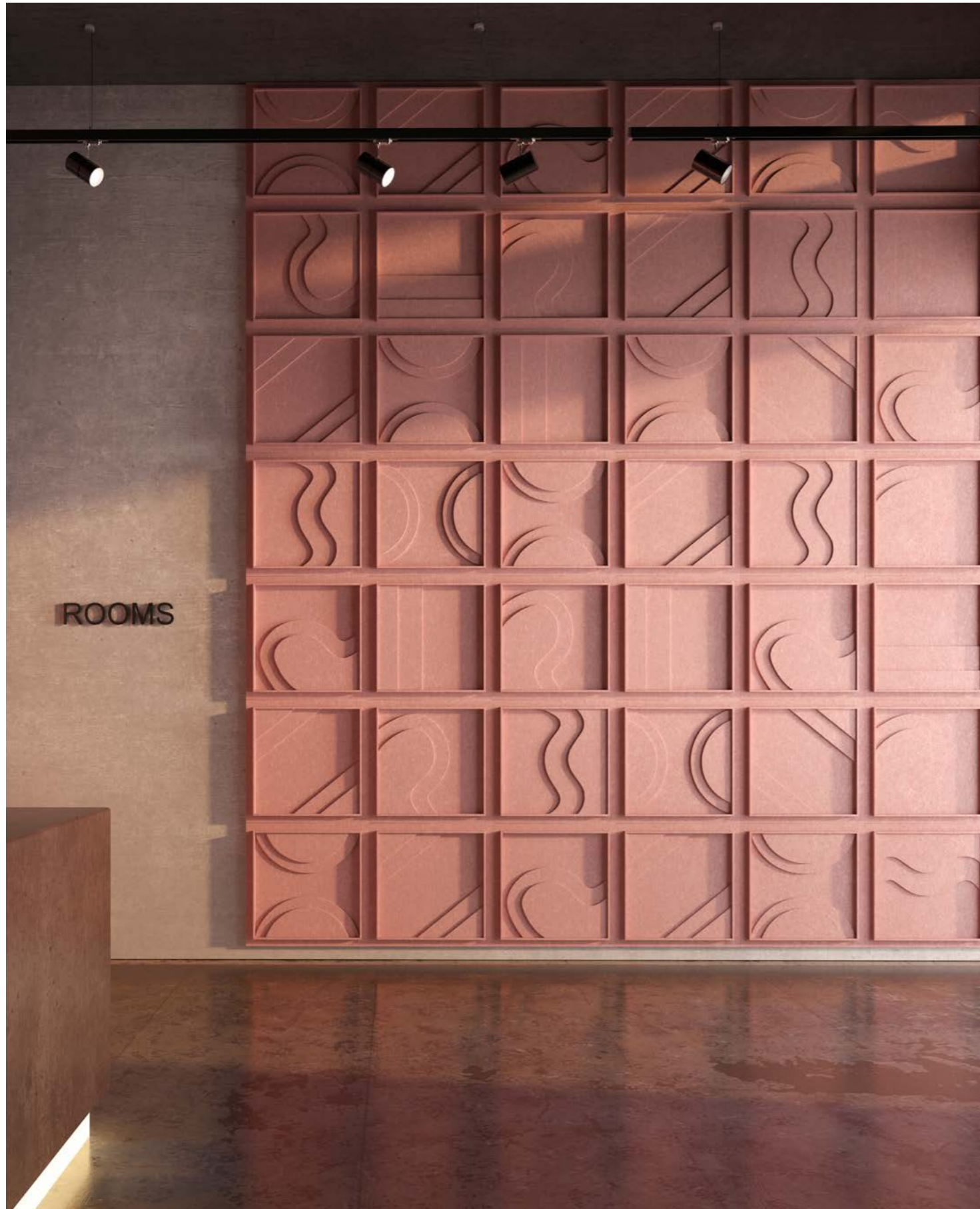

ECOWall  
Strata  
**Technical  
sheet — P169**

## Strata

Inspirado en los mapas topográficos para crear una abstracción de formas singulares. Dependiendo de las sensaciones que queremos transmitir podemos variar su color, creando espacios únicos y exclusivos.

Inspired by topographic maps to create an abstraction of unique shapes. Depending on the sensations we want to convey, we can vary its color, creating unique and exclusive spaces.



Erico  
Navazo

Distinguished Spanish interior designer, embodies elegance and subtlety in design. With a vision that avoids the ephemeral, he prioritizes authenticity and functionality, blending noble materials with the latest technology. His designs, inspired by nature and art, advocate for timeless and conscious interior design, standing out for his ability to create authentic spaces that resonate with his clients' souls.

Distinguido interiorista español, es la encarnación de la elegancia y la sutilidad en el diseño. Con una visión que evita lo efímero, privilegia la autenticidad y la funcionalidad, fusionando materiales nobles con la más alta tecnología. Sus diseños, inspirados en la naturaleza y el arte, promueven un interiorismo atemporal y consciente, destacando por su habilidad para crear espacios auténticos que resuenan con el alma de sus clientes.



## V-Cut

Beveling adds a sophisticated dimension to design, allowing for creative configurations and unique interplays of light. These panels, in addition to their design contribution, optimize the acoustic quality of spaces, providing tranquility and style in an eco-friendly solution.

El biselado aporta una dimensión sofisticada al diseño, permitiendo configuraciones creativas y juegos de luz únicos. Estos paneles, además de su contribución al diseño, optimizan la calidad acústica de los espacios, brindando tranquilidad y estilo en una solución eco-amigable.



ECOWall  
V-cut  
**Technical  
sheet — P170**



ECOWall  
V-cut  
**Technical**  
sheet — P170







ECOWall  
V-cut  
**Technical  
sheet — P170**

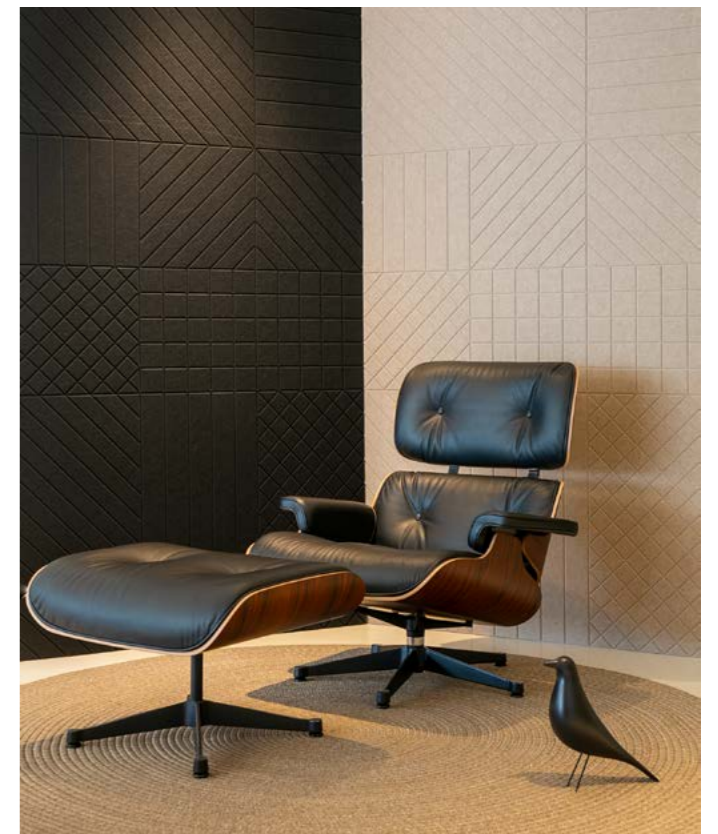



## Volume

Delve into the complexity of nature, adding depth and acoustics to your space. These double panels with organic shapes create a serene and attractive environment with an ecological approach.

Indaga en la complejidad de la naturaleza, agregando profundidad y acústica a tu espacio. Estos paneles, dobles y con formas orgánicas, crean un ambiente sereno y atractivo con un enfoque ecológico.

ECOWall  
Volume  
**Technical  
sheet — P172**





ECOWall  
Volume  
**Technical  
sheet — P172**





ECOWall  
Volume  
**Technical**  
sheet — P172



ECOWall  
Volume  
**Technical  
sheet — P172**





## Emotion

Revitalize your space with panels that mirror the boldness of contemporary art and the cutting-edge of design. These elements not only enhance acoustics but also infuse a distinctive and exclusive character, capturing the essence of aesthetic innovation.

Revitaliza tu espacio con paneles que reflejan la audacia del arte contemporáneo y la vanguardia del diseño. Estos elementos no solo mejoran la acústica, sino que también infunden un carácter distintivo y exclusivo, capturando la esencia de la innovación estética.

ECOWall  
Emotion  
**Technical**  
sheet — P174



ECOWall  
Emotion  
**Technical**  
**sheet — P175**



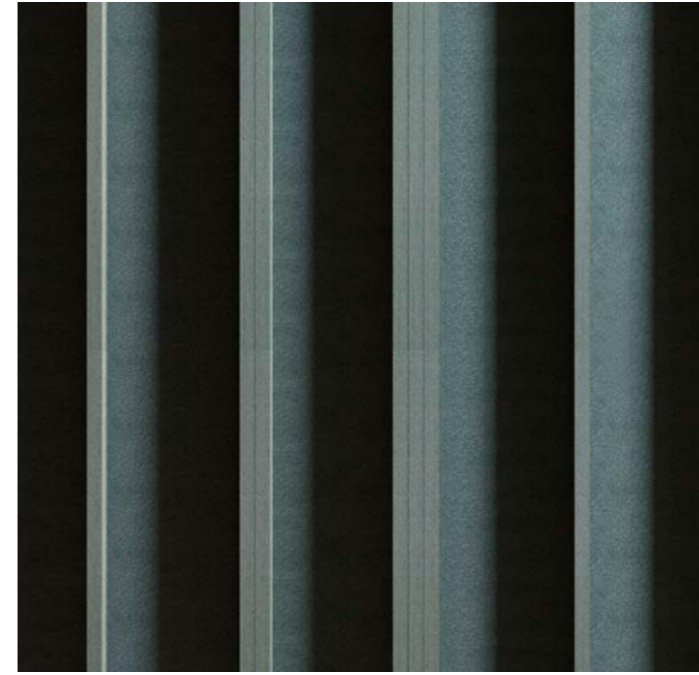

ECOWall  
Emotion  
**Technical  
sheet — P176**



## **ECONordik**

In the forest, the whispers of life grow louder. With every step, the rustling of leaves beneath our feet narrates age-old tales. We find sanctuary in the chaos, a promise of peace.

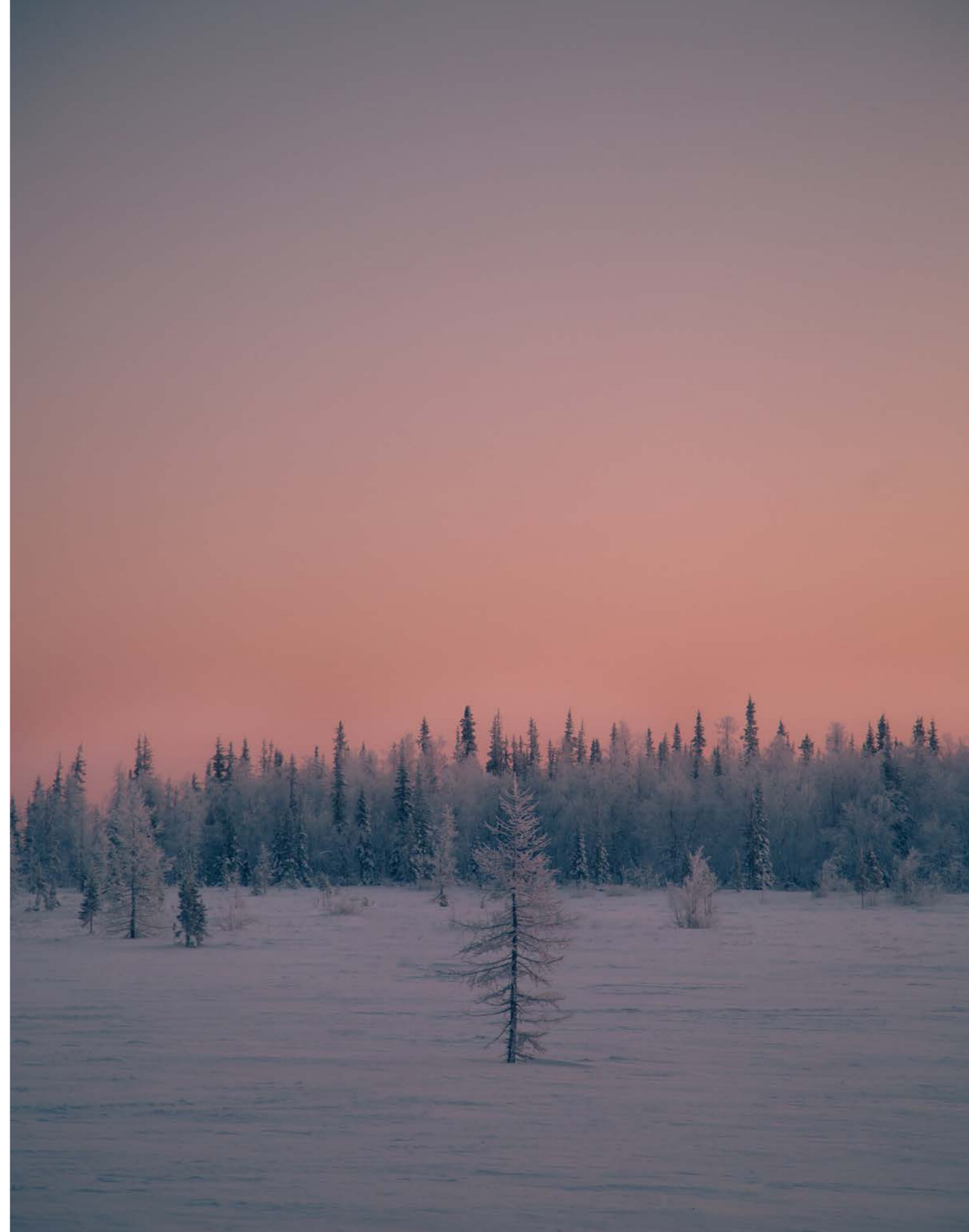



Discover the fusion of the warmth of wood and acoustic excellence with eco-friendly panels. Textures like oak and ash ally with color to create elegant and environmentally conscious spaces.

Descubre la fusión de la calidez de la madera y la excelencia acústica con paneles ecológicos. Texturas como roble y fresno se alían con el color para crear espacios elegantes y conscientes.

Technical sheet — P178-183  
**Wood Colours — P181**  
**PET Colours — P211**





EONordik  
Meet  
**Technical**  
sheet — P178

## Meet



by Erico  
Navazo

Combine the timeless aesthetics of wood with colorful backings, offering adaptable design and spectacular acoustics. They are ideal for any space, providing functionality, personalization, and elegance with versatile and sustainable use.

Une la estética atemporal de la madera con traseras de color, ofreciendo diseño adaptable y una espectacular acústica. Son ideales para cualquier espacio, aportando funcionalidad, personalización y elegancia con un uso versátil y sostenible.



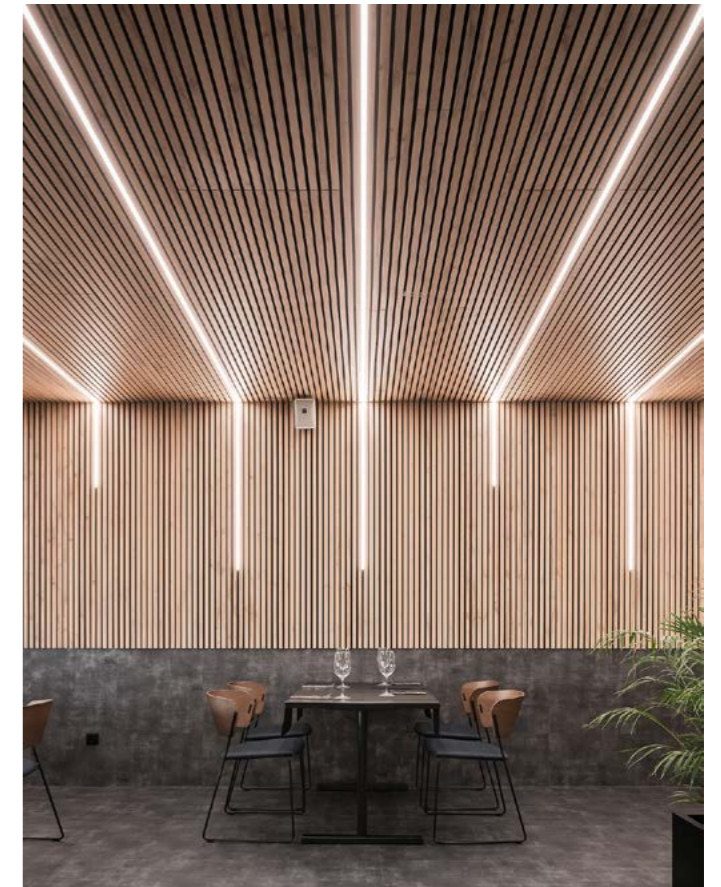

EONordik  
Technical  
sheet — P180



ECONordik  
Technical  
sheet — P180





## Curve

Combine the timeless aesthetics of wood with colorful backings, offering adaptable design and spectacular acoustics. They are ideal for any space, providing functionality, personalization, and elegance with versatile and sustainable use.

Une la estética atemporal de la madera con traseras de color, ofreciendo diseño adaptable y una espectacular acústica. Son ideales para cualquier espacio, aportando funcionalidad, personalización y elegancia con un uso versátil y sostenible.

EONordik  
Curve  
**Technical  
sheet — P180**

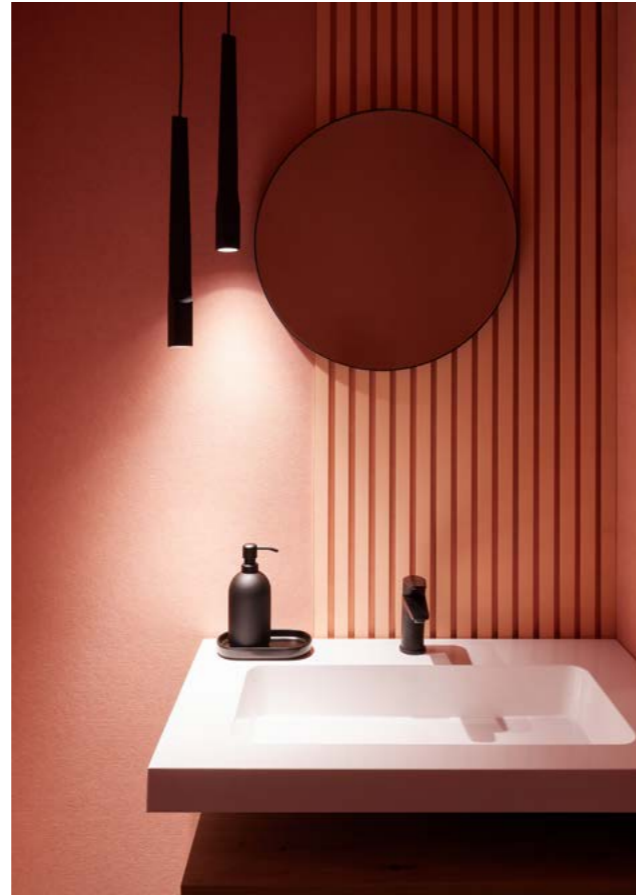

## Colour

Integrate the timeless elegance of wood with a custom color touch, enhancing the aesthetics and acoustics of any setting. In the elegance of spaces, these painted panels offer functionality, adaptability, and design, with ecological awareness.

Integra la elegancia atemporal de la madera con un toque de color a medida, mejorando la estética y la acústica de cualquier ambiente. En la elegancia de los espacios, estos paneles pintados ofrecen funcionalidad, adaptabilidad y diseño, con conciencia ecológica.

EONordik  
Colour  
**Technical  
sheet — P180**



EONordik  
Pintado  
**Technical**  
**sheet — P180**







# SEAQUAL INITIATIVE

In the vast depths of our oceans, the SEAQUAL INITIATIVE embarks on a silent but vital rescue mission. Its purpose: to recover the forgotten plastics that lie in the waters, mute witnesses of our consumerist era. These remnants, once insignificant and discarded, begin a journey of transformation thanks to ECOcero. In their hands, each piece of marine plastic is reimagined, reborn as completely new and eco-friendly PET panels. These panels not only tell the story of their oceanic origin but also symbolize a vision of sustainability and respect for our environment. In each panel, the SEAQUAL INITIATIVE and ECOcero encapsulate the promise of a greener future, where every piece of plastic rescued from the sea becomes an expression of change and hope.

En las vastas profundidades de nuestros océanos, SEAQUAL INITIATIVE se embarca en una misión de rescate silenciosa pero vital. Su propósito: recuperar los plásticos olvidados que yacen en las aguas, testigos mudos de nuestra era consumista. Estos restos, una vez insignificantes y desechados, inician un viaje de transformación gracias a ECOcero. En sus manos, cada fragmento de plástico marino es reimaginado, renaciendo como paneles de PET completamente nuevos y ecológicos. Estos paneles no solo cuentan la historia de su origen oceánico, sino que también simbolizan una visión de sostenibilidad y respeto por nuestro entorno. En cada panel, SEAQUAL INITIATIVE y ECOcero encapsulan la promesa de un futuro más verde, donde cada pieza de plástico rescatada del mar se convierte en una expresión de cambio y esperanza.

## **ECOceiling**

Upon reaching the summit, the world seems to stand still. Silence embraces each stone, every blade of grass. And in that vast stillness, for a moment, we become one with the wind, masters of a flawless fate.

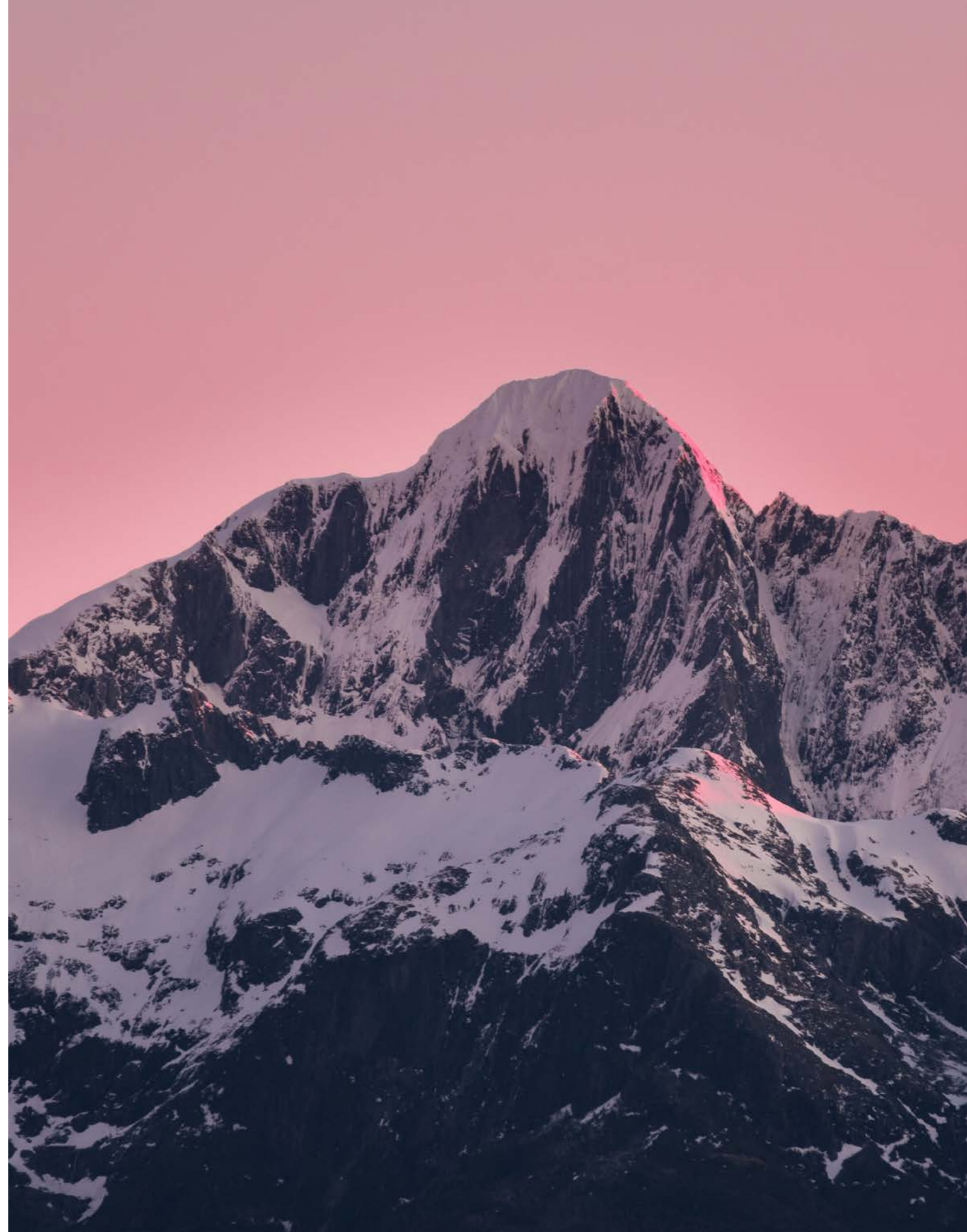



Bring life to ceilings with recycled acoustic panels, where choice becomes an act of creativity. Enhance your space with design, comfort, and an installation so simple it inspires, redefining what it means to have a sustainable and stylish environment.

Da vida a los techos con paneles acústicos reciclados, donde la elección se convierte en un acto de creatividad. Beneficia a tu espacio con diseño, confort y un montaje tan sencillo que inspira, redefiniendo lo que significa un ambiente sostenible y con estilo.



Technical  
sheet — P184-193  
Colours — P211



# Flap

This acoustic system reinvents the ambiance with 360-degree rotating slats, allowing for instant modifications of both acoustics and color in the space. It offers a versatile environment where each adjustment introduces a new design and customization.

Este sistema acústico reinventa el ambiente con lamas giratorias de 360 grados, permitiendo modificar la acústica y el color del espacio al instante. Ofrece un entorno versátil, donde cada ajuste trae un nuevo diseño y customización.



Rafa Ortega

Rafa Ortega is a true trailblazer in Valencia's design scene, co-directing the studio gutierrezortega with Cristina Gutiérrez for nearly 30 years. An inventor of solutions and a designer of ideas, he's passionate about innovation and tirelessly visionary. From his mind, heart, and hands have come patents that make the world more comfortable and sustainable. His work infuses emotion and creativity into product development for offices, public spaces, hospitality, and homes, offering distinctive solutions and thorough support throughout all stages of a project, from identifying a need to launching the final product.

Rafa Ortega es un verdadero pionero en la escena del diseño valenciano, codirigiendo el estudio gutierrezortega con Cristina Gutiérrez durante casi 30 años. Inventor de soluciones y diseñador de ideas, es un apasionado de la innovación y un visionario incansable. De su mente, corazón y manos han surgido patentes que hacen al mundo más cómodo y sostenible. Su trabajo inyecta emoción y creatividad en el desarrollo de productos para oficinas, espacios públicos, hostelería y hogares, ofreciendo soluciones distintivas y apoyo exhaustivo en todas las etapas del proyecto, desde la identificación de una necesidad hasta el lanzamiento del producto final.

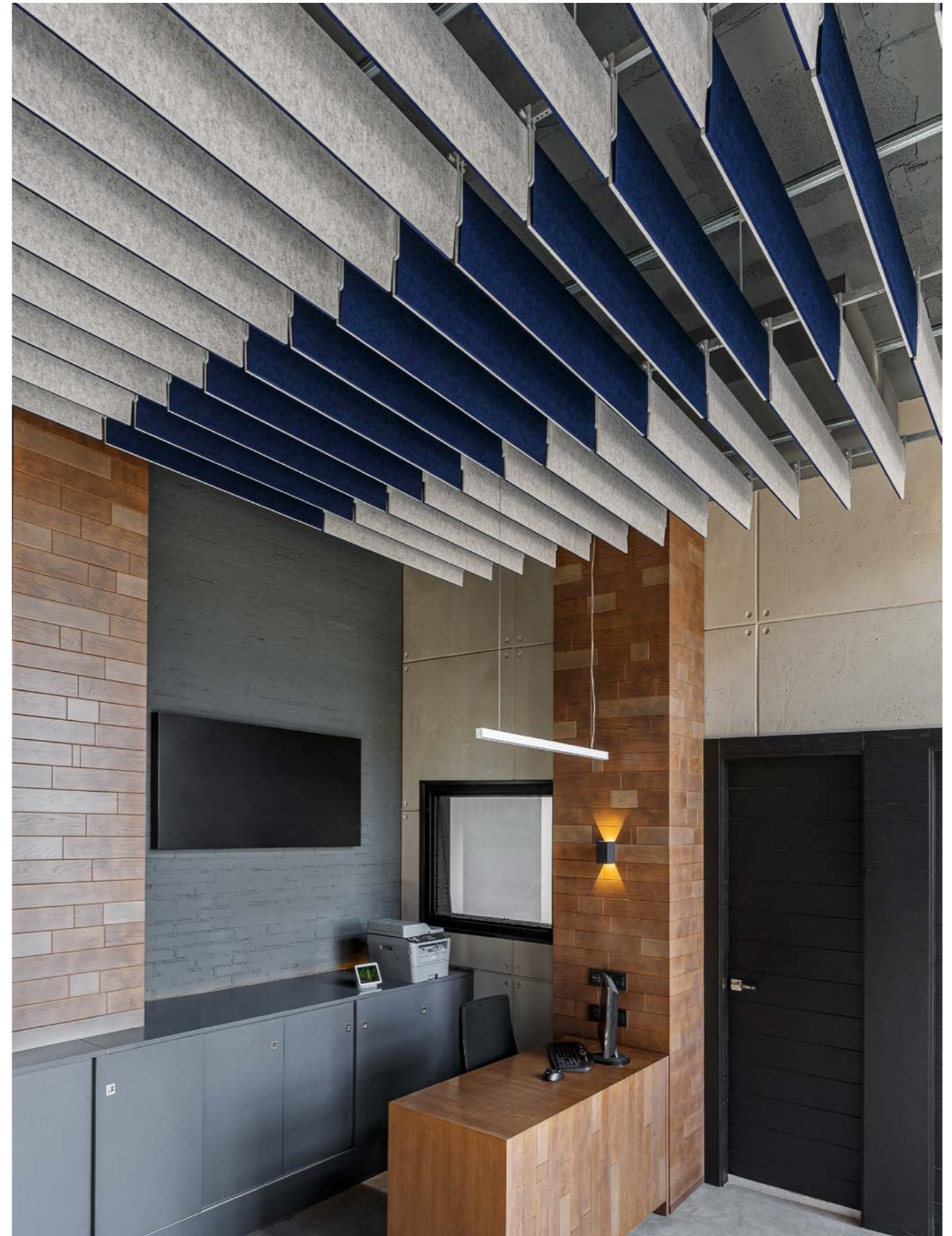

ECOceiling  
Flap  
**Technical  
sheet — 184**



## Code

Designed by Rafa Ortega

This eco-friendly ceiling design captures the essence of modernity, drawing inspiration from barcode patterns. It allows for the customization of lighting and signage using eco-conscious materials and colors. Its distinctive vertical ribs can be adjusted in distance and hue, creating a unique and personalized visual play.

Este diseño de techo ecológico captura la esencia de la modernidad con su inspiración en patrones de códigos de barras. Personaliza la luz y señalética utilizando materiales y colores eco-conscientes. Sus distintivas costillas verticales se ajustan en distancia y tonalidad, creando un juego visual único y personalizado.

ECOceiling  
Code  
**Technical  
sheet — 186**

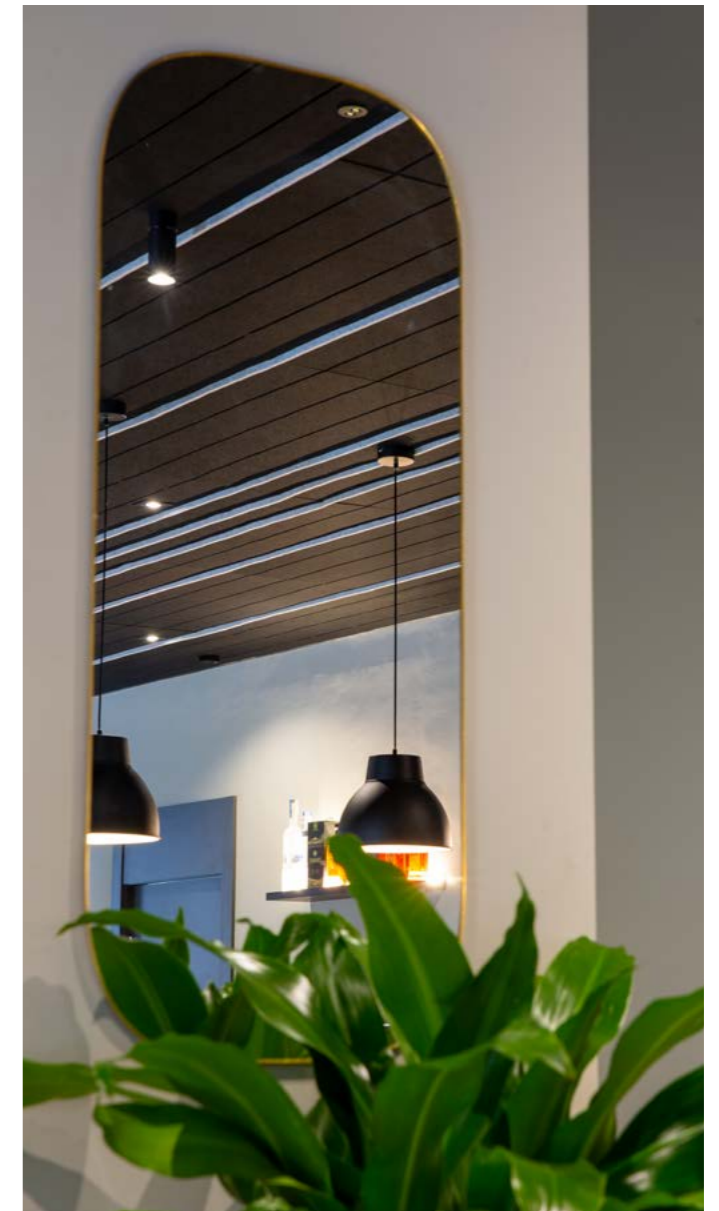



**ECO**ceiling | Acoustic design.

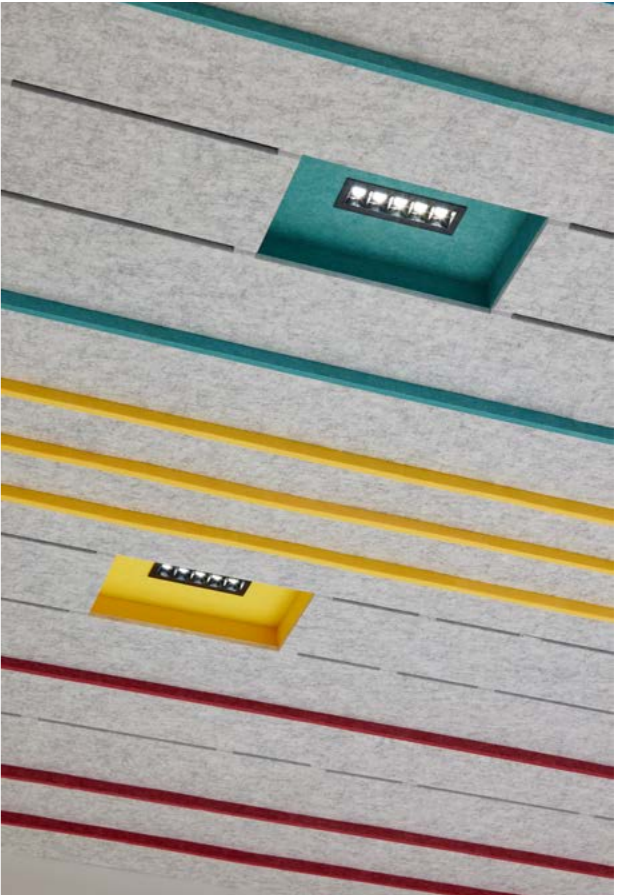

ECOceiling  
Code  
**Technical  
sheet — 186**



## Circular

Designed by Rafa Ortega

This eco-acoustic ceiling brings volumetric dynamism to any space. Customize the number and suspension of the elements to create unique atmospheres with varied spatial perceptions. This organic design incorporates variable backlighting at its top, serving a dual purpose: infusing color into the space and casting light and shadow play that adds depth.

Aporta dinamismo volumétrico a cualquier espacio. Personaliza el número y la suspensión de los elementos para crear ambientes únicos con diferentes percepciones espaciales. Este diseño orgánico puede incorporar retroiluminación variable en su parte superior, cumpliendo una doble función: infundir color en el espacio y crear un juego de luces y sombras que añada profundidad.

ECOceiling  
Circular  
**Technical  
sheet — 188**





## Quadrilateral

Designed by Openbook

Reclaim tradition with its classic and minimalist design of shapes and color, bringing a sense of order and serenity. It creates a peaceful ambiance and a refined aesthetic, perfect for those who value simplicity and design.

Recupera la tradición con su diseño clásico y minimalista de las formas y el color, aportando una sensación de orden y serenidad. Genera un ambiente tranquilo y una estética depurada, perfecta para quienes valoran la sencillez y el diseño.

ECOceiling  
Quadrilateral  
**Technical  
sheet — 190**

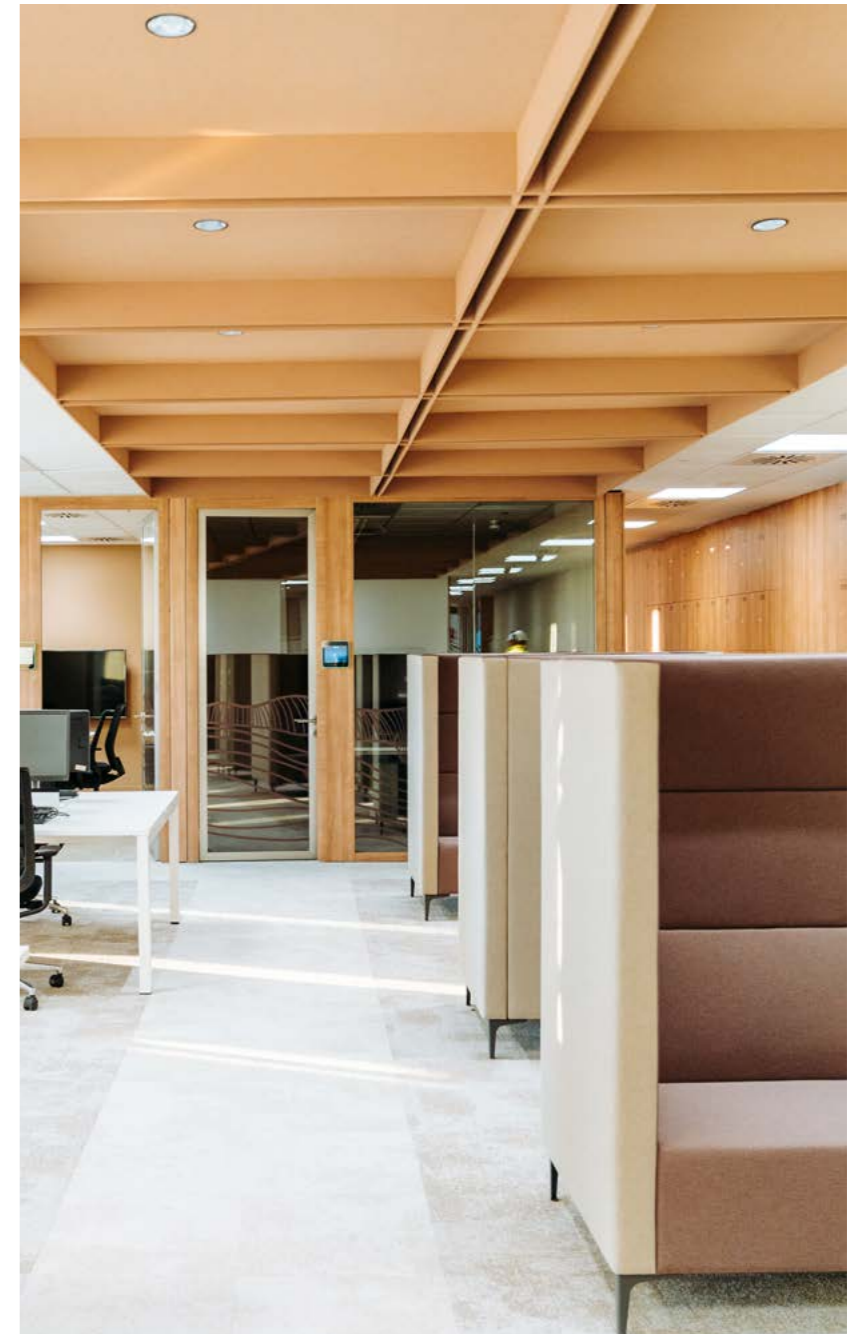





ECOceiling  
Quadrilateral  
**Technical**  
sheet — 190



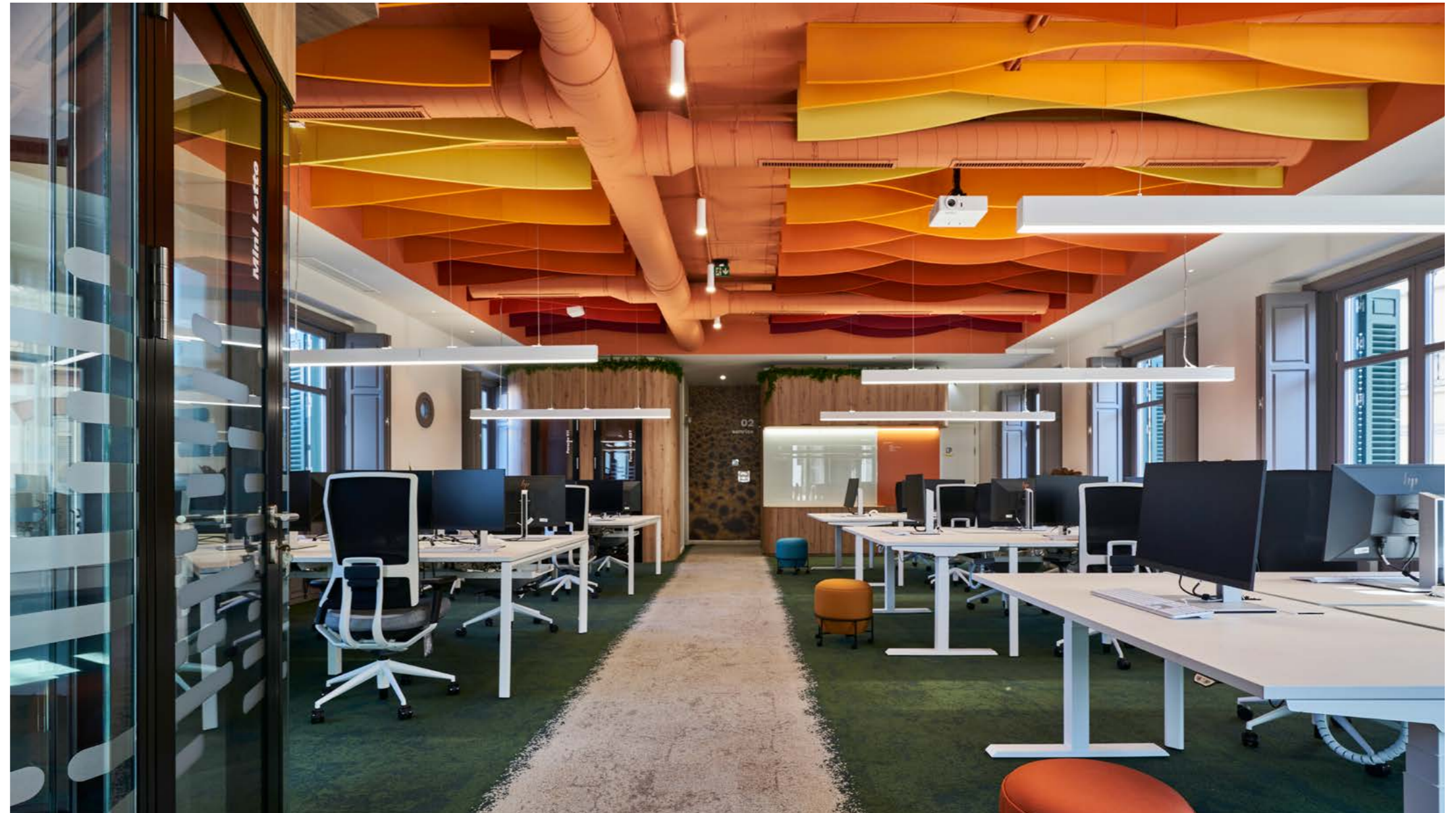

## Baffle

Transform ceilings into design masterpieces with vertical panels of various shapes that harmonize elegance and sound. Ideal for innovative spaces, they blend unique design with acoustic comfort, creating attractive and functional environments.

Transforma techos en obras de diseño con paneles verticales de formas diversas, que armonizan la elegancia y el sonido. Ideales para espacios innovadores, combinan diseño único con confort acústico, creando ambientes atractivos y funcionales.

ECOceiling  
Baffle  
**Technical  
sheet — 191**



ECOceiling  
Baffle  
**Technical  
sheet — 191**





ECOceiling  
Baffle  
**Technical  
sheet — 191**



## Cloud

Transform your ceiling into a landscape of tranquility with our acoustic solution that invites imagination. Each configuration is unique, opening up a sky of creative possibilities. With ECOcloud, breathe the life into balanced and harmonious environments, personalized in design, color, and size.

Transforma tu techo en un paisaje de tranquilidad con nuestra solución acústica que invita a la imaginación. Cada configuración es única, abriendo un cielo de posibilidades creativas. Con ECOcloud, da vida a ambientes equilibrados y armónicos, personalizados en diseño, color y tamaño.

ECOceiling  
Cloud  
**Technical  
sheet — 192**



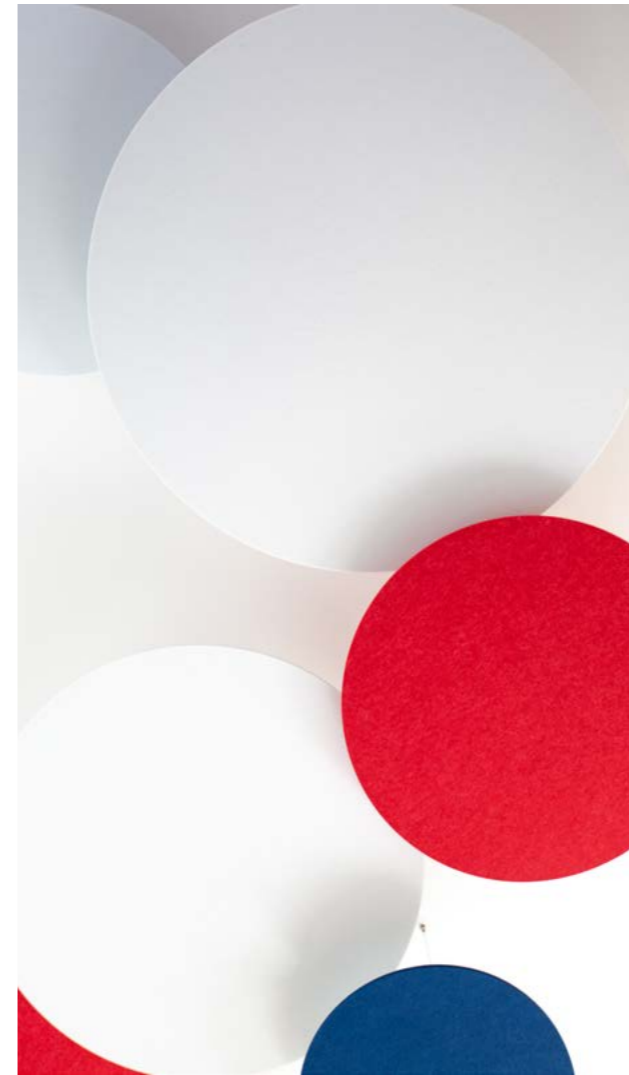

ECOceiling  
Cloud  
**Technical**  
sheet — 192



ECOceiling  
Cloud  
**Technical  
sheet — 192**

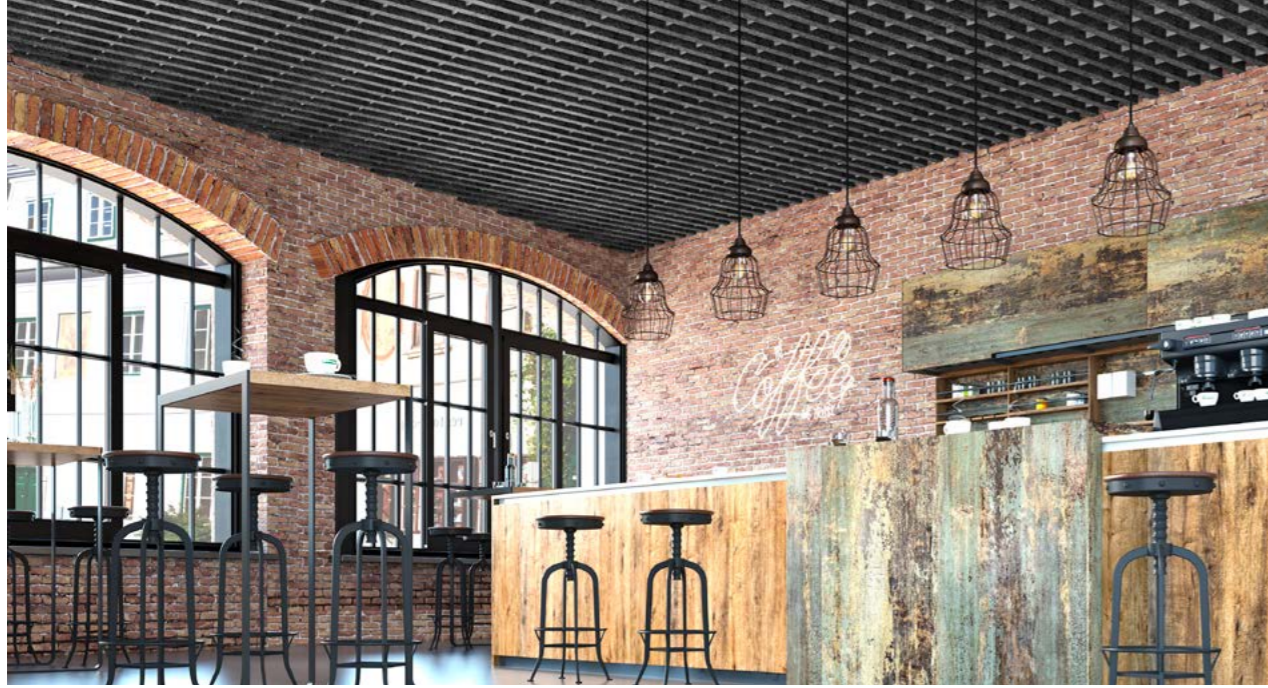

## Aline

Revitalize your space with a classic-design ceiling, entirely composed of recycled materials. Its rectangular shapes align with a minimalist and orderly aesthetic, offering a sustainable and elegant approach that redefines simplicity in modern architecture.

Revitaliza tu espacio con un techo de diseño clásico, compuesto íntegramente por materiales reciclados. Sus formas rectangulares se alinean con una estética minimalista y ordenada, ofreciendo un enfoque sostenible y elegante que redefine la simplicidad en la arquitectura moderna.

ECOceiling  
Aline  
**Technical  
sheet — 193**







ECOceiling  
Aline  
**Technical  
sheet — 193**



## **ECollections**

At the heart of nature, each leaf tells a story, each breeze whispers of unseen wonders, where imagination sketches vivid dreams in our minds.

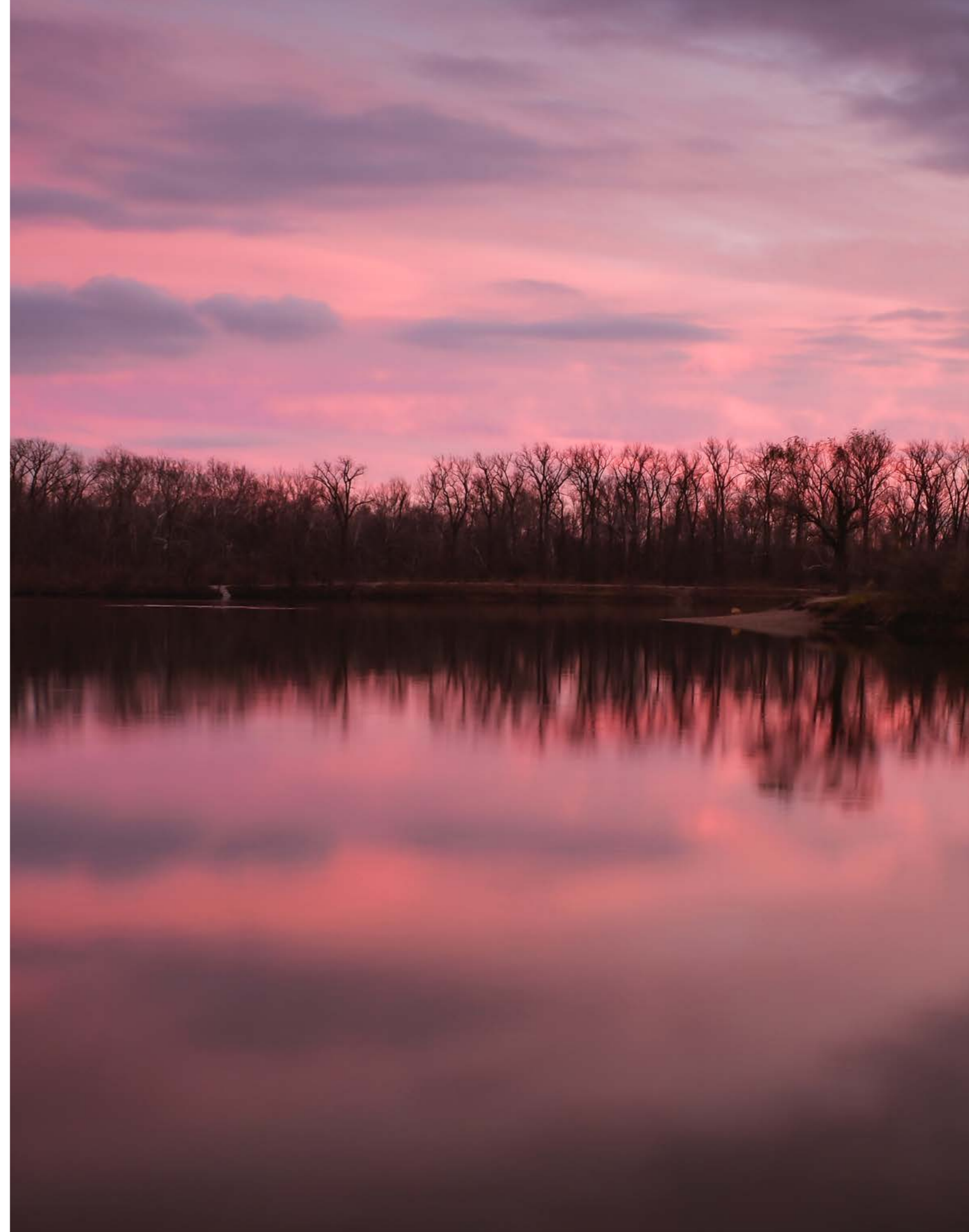



Technical  
sheet — P194-205  
Colours — P211

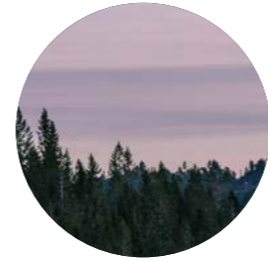

Acoustic panels from exclusive collections, where design and imagination converge to transform your space. Each panel is a piece that not only perfects the ambient's sound quality but also infuses a unique and sophisticated style, ideal for those who value aesthetics as much as functionality.

Paneles acústicos de colecciones exclusivas, donde el diseño y la imaginación se encuentran para transformar tu espacio. Cada panel es una pieza que no solo perfecciona la sonoridad del ambiente, sino que también infunde un estilo único y sofisticado, ideal para quienes valoran la estética tanto como la funcionalidad.





## Lumomesh

The Room Studio introduces LUMOMESH, an acoustic solution blending simplicity with adaptability, overcoming the market's versatility gap. This product adapts to any space, allowing total customization in lighting and color to create unique and welcoming environments, whether on walls, ceilings, or architectural details. LUMOMESH stands for elegance and customized design, merging acoustics and lighting into a single element.

The Room Studio introduce LUMOMESH, una solución acústica que combina simplicidad con adaptabilidad, superando la falta de versatilidad en el mercado. Este producto se ajusta a cualquier espacio, permitiendo personalización total en iluminación y color, creando ambientes únicos y acogedores, ya sea en paredes, techos o detalles arquitectónicos. LUMOMESH es sinónimo de elegancia y diseño personalizado, integrando acústica e iluminación en un solo elemento.

ECollections  
Lumomesh  
**Technical  
sheet — 194**



## The Room Studio

The Room Studio turns visions into tangible realities, with Meritxell Ribé and Josep Puigdomènech leading a team that harmonizes well-being with design. Each space is a personal narrative, woven with select materials, detailed lighting, and advanced technology. More than design and construction, it's a creative collaboration that reflects life stories in every environment, inviting clients on a journey of spatial transformation.

The Room Studio transforma visiones en realidades tangibles, con Meritxell Ribé y Josep Puigdomènech liderando un equipo que armoniza bienestar y diseño. Cada espacio es una narrativa personal, tejida con materiales selectos, iluminación detallada y tecnología avanzada. Más que diseño y construcción, es una colaboración creativa para reflejar historias de vida en cada entorno, invitando a los clientes a emprender un viaje de transformación espacial.



ECollections  
Puzzle  
**Technical**  
sheet — 196



## Puzzle

Inspired by Mark Rothko, the Puzzle design blends colors and shapes for a creative and impactful function. A modular and emotional product, with four pieces of varying sizes offering endless combinations, allowing for the personalization of your project with a myriad of color options.

Inspirado en Mark Rothko, el diseño de Puzzle mezcla colores y formas para impactar y funcionar creativamente. Un producto modular y emocional, con cuatro piezas de distintos tamaños que ofrecen infinitas combinaciones, permitiendo personalizar tu proyecto con un sinnúmero de opciones cromáticas.



## Masqueespacio

Masqueespacio, founded by Ana Milena Hernández Palacios and Christophe Penasse, excels in crafting unique experiences with a fresh, strategic approach that captivates end-users. This design studio is a breeding ground for ideas that transform brands into coveted icons. Their philosophy champions authenticity and innovation, generating spaces and products that break the mold. With Mas Creations, the brand ventures further, creating items that tell stories and add joy to daily life, always aiming to surprise and delight.

Masqueespacio, creado por Ana Milena Hernández Palacios y Christophe Penasse, se especializa en forjar experiencias únicas con un enfoque fresco y estratégico que cautiva a los usuarios. Este estudio de diseño es un caldo de cultura para ideas que transforman marcas en íconos del deseo. Su filosofía aboga por la autenticidad y la innovación, generando espacios y productos que trascienden lo convencional. Con Mas Creations, la marca se aventura más allá, creando objetos que cuentan historias y añaden alegría a la vida cotidiana, siempre buscando sorprender y deleitar.

# Breeze

An innovative and sustainable luminaire aligns with the ceiling, visually reflecting the sound spectrum. This creation harmonizes with the rhythm of everyday life, capturing the complexity of natural sound and translating it into a design that benefits the user through resonant patterns and frequencies.

Una luminaria innovadora y sostenible se alinea con el techo, reflejando visualmente el espectro sonoro. Esta creación armoniza con el ritmo de la vida cotidiana, capturando la complejidad del sonido natural y traduciéndolo en un diseño que beneficia al usuario mediante patrones y frecuencias resonantes.

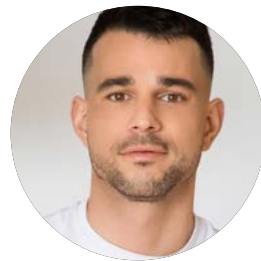

Noé  
Prades

Noé Prades, an interior design visionary, crafts spaces that breathe emotions and narrate stories. Mastering the interplay of light and shadow, his designs invite unique sensory experiences, turning each environment into a personal haven. Recognized by Architectural Digest as one of Spain's finest, Noé is renowned for his creativity and elegantly detailed elegance, advocating for a sustainable and emotionally enriching lifestyle.

Noé Prades, un visionario del diseño interior, crea espacios que respiran emociones y cuentan historias. Con un juego maestro de luces y sombras, sus diseños invitan a experiencias sensoriales únicas, donde cada ambiente se convierte en un refugio personal. Reconocido por Architectural Digest entre los mejores de España, Noé destaca por su creatividad y una elegancia cuidada al detalle, promoviendo un estilo de vida sostenible y emocionalmente enriquecedor.

ECollections  
Breeze  
**Technical  
sheet — 197**

ECollections  
Colibrí  
**Technical  
sheet — 198**

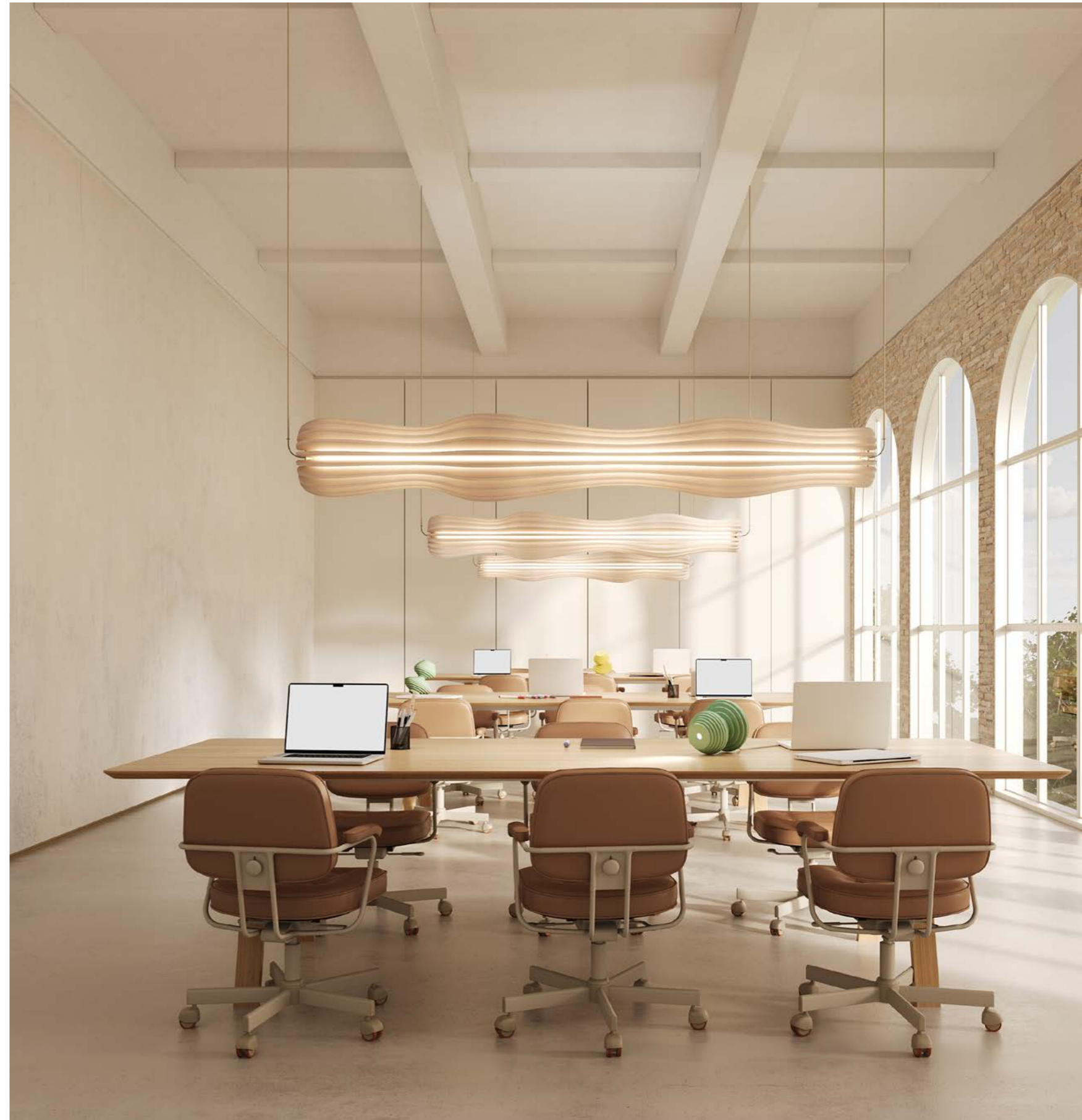



## Texture

The most contemporary and cutting-edge range. Crafted by Welcome Design, a team with vast experience and a passion for design, they have created some of the landmark projects in recent years. EcoTextures is a quest for the most exceptional pieces, offering an endless array of colors and a meticulous selection of repeat designs and murals that adapt to any space.

La serie más moderna y atrevida, forjada por Welcome Design, un equipo rebosante de experiencia y amor por el diseño, responsables de emblemáticos proyectos recientes. EcoTextures es una exploración en pos de las piezas más extraordinarias, con un espectro cromático ilimitado y una exquisita selección de patrones y murales adaptables a todo espacio.



Welcome  
Design

Welcome Design stands out for its creativity and vibrant use of colors, drawing inspiration from the personalities of their clients to design lively spaces full of character. They are distinguished by blending current trends with imaginative solutions, always prioritizing design and quality. Their ability to transform any environment into a livable work of art is the hallmark of their studio, where each detail tells the story of boundless inspiration.

Welcome Design destaca por su creatividad y el uso vibrante de colores, inspirándose en la personalidad de sus clientes para diseñar espacios vivos y llenos de carácter. Se distinguen por fusionar tendencias actuales con soluciones imaginativas, siempre poniendo el diseño y la calidad en primer plano. Su capacidad para transformar cualquier entorno en una obra de arte habitable es el sello de su estudio, donde cada detalle cuenta la historia de una inspiración sin límites.

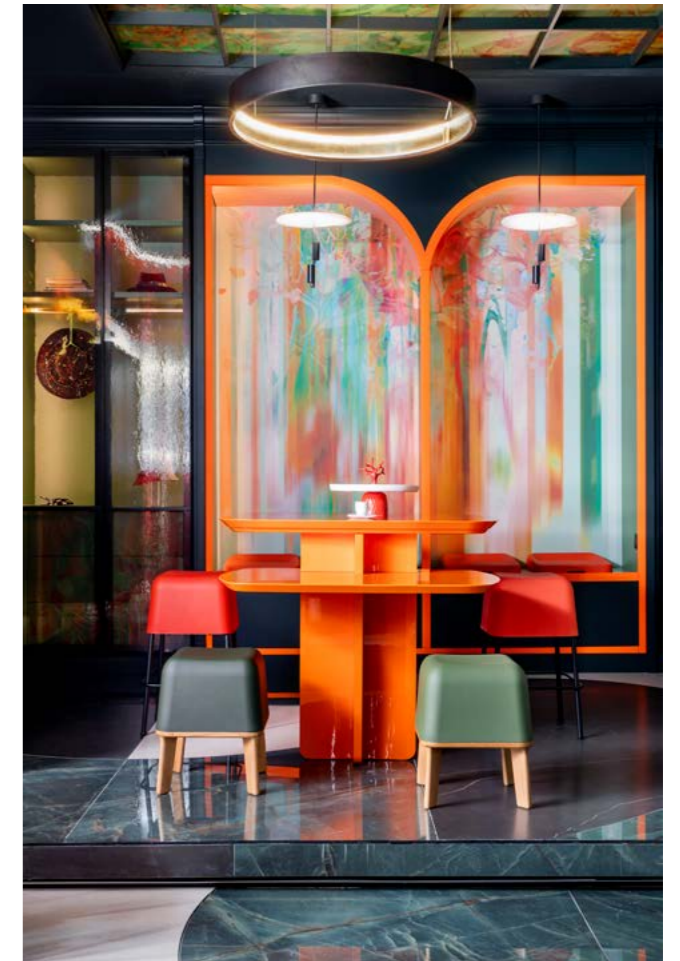

ECollections  
Texture  
**Technical  
sheet — 199**



ECollections  
OTOGreen Wall  
**Technical  
sheet — 200**

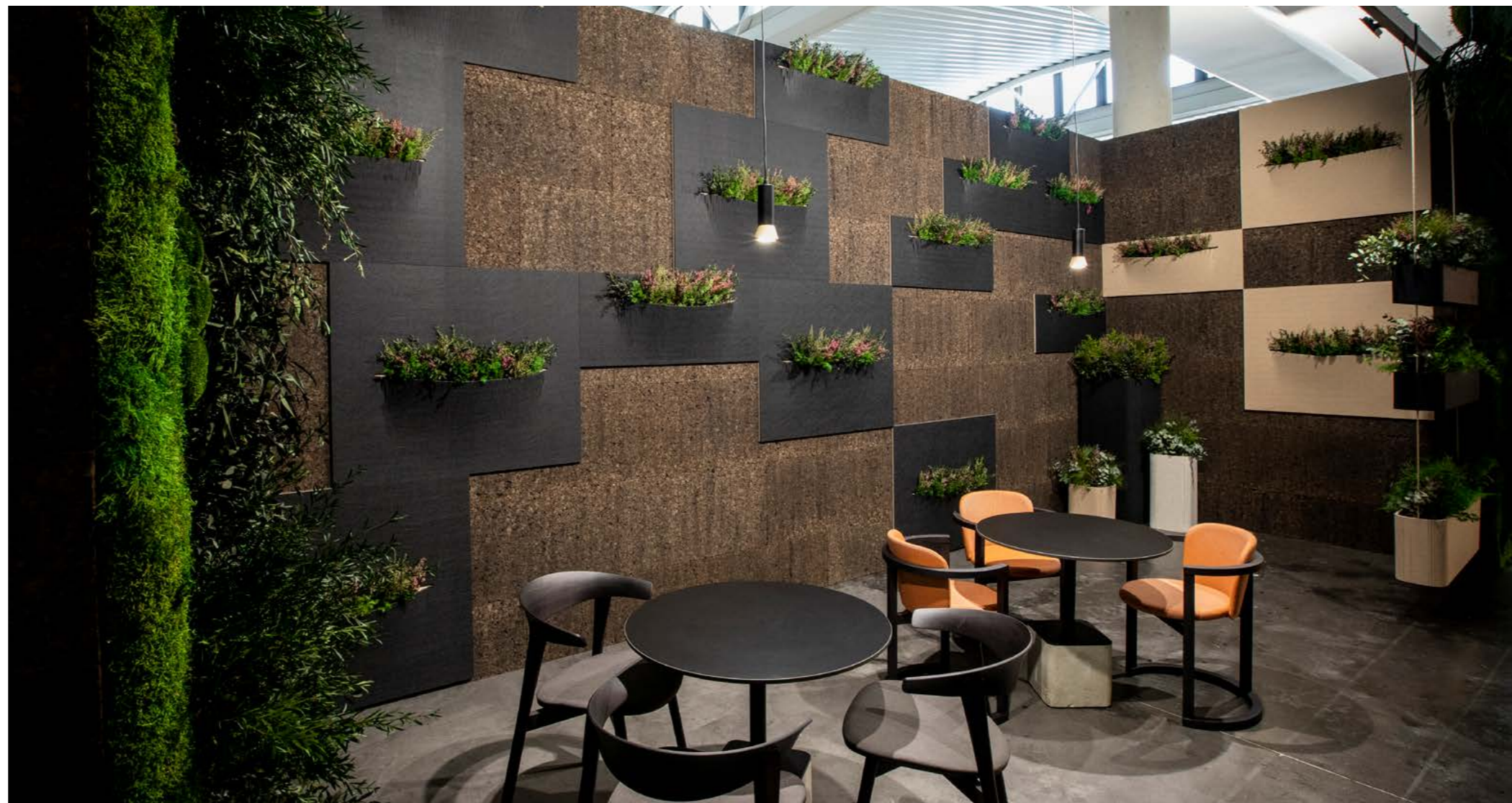

## OTOGreen Wall



Designed  
by Rafa  
Ortega

In partnership with Greenarea, OTOgreen Wall allows you to incorporate a slice of nature into your space. It's a superb aesthetic solution for interiors that also enhances air quality and creates a healthier, more welcoming atmosphere for people, all while being kind to nature.

En alianza con Greenarea, OTOgreen Wall te brinda un fragmento de naturaleza para tu entorno. Es una solución estética ideal para interiores, que también mejora la calidad del aire y genera un espacio más sano y acogedor, en armonía con el medio ambiente.



# OTogreen Planter

Designed by Rafa Ortega

In a world where nature, ecology, and comfort merge, the options to connect indoor spaces with the natural world are boundless. Planters with preserved plants enable simple room separation to highly creative compositions, whether on walls, floors, or tables. A Greenarea product that evokes intense organic sensations.

En un mundo donde naturaleza, ecología y confort se unen, las opciones para conectar espacios interiores con el exterior son ilimitadas. Las jardineras de Greenarea con plantas preservadas permiten desde una sencilla separación de ambientes hasta creativas composiciones en paredes, suelos o mesas, evocando intensas sensaciones orgánicas.



ECollections  
OTogreen Planter  
**Technical  
sheet — 202**





## Quiet

Designed by Rafa Ortega

Explore a new dimension of office well-being with dividers made from our ECOcero material, designed to enhance your experience with acoustic comfort and visual privacy, while enjoying the mobility and adaptability that these innovative dividers provide.

Explora una nueva dimensión de bienestar en tu oficina con divisores hechos de nuestro material ECOcero, diseñados para enriquecer la experiencia con un confort acústico y privacidad visual, todo mientras disfrutas de la movilidad y adaptabilidad que proporcionan estos innovadores divisores.



ECollections  
Quiet  
**Technical  
sheet — 204**

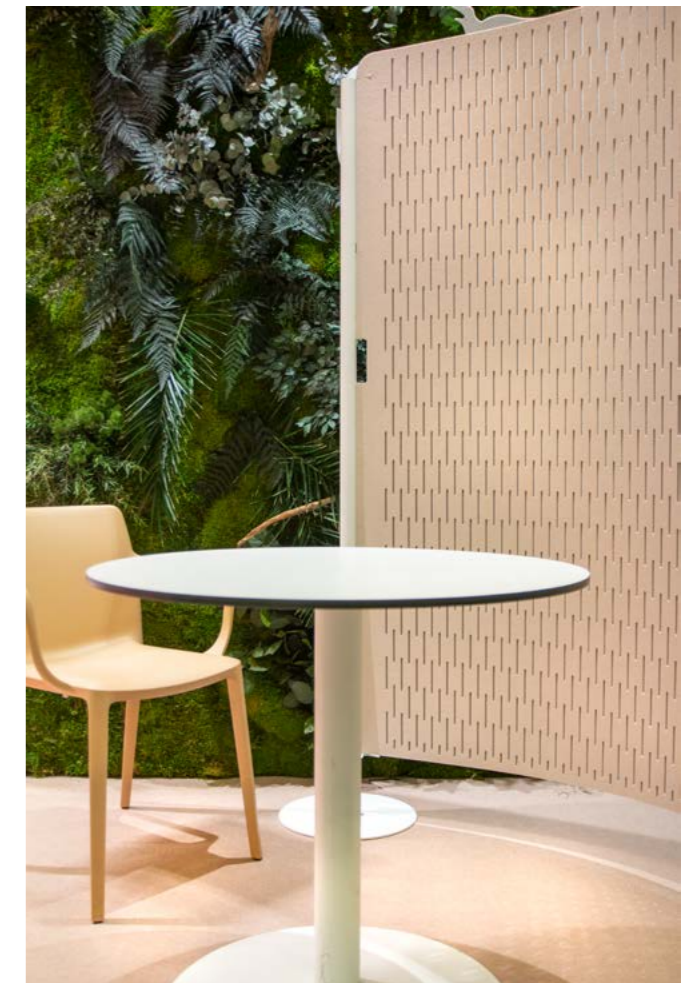

## ECOImagine

Gazing at the blank canvas, the painter feels a symphony of colors dancing in his mind, an uncharted universe where each stroke becomes a heartbeat, a whisper of life yearning to be born beneath his brush.





Embark on a creative journey with our ECOImagine collection, where imagination and customization are at the heart of design. Unleash your creativity with pieces that invite you to envision your ideal space. This collection celebrates individual expression, offering the tools to tailor each piece to your taste and transform any environment into a reflection of your unique vision.

Embárcate en un viaje creativo con nuestra colección ECOImagine, donde la imaginación y la personalización son el núcleo del diseño. Libera tu creatividad con piezas que te invitan a visualizar tu espacio ideal. Esta colección celebra la expresión de la creatividad individual, ofreciendo las herramientas para personalizar cada elemento a tu gusto y transformar cualquier entorno en un reflejo de tu visión única.



## ECOprint

Our ECOprint panel collection is a canvas for imagination, allowing you to imprint your own designs or choose from our exclusive selection. Each panel becomes a statement of personal style and boundless creativity, inviting you to transform any space into a gallery of visual expression and ecological commitment.

Nuestra colección de paneles ECOprint es un lienzo para la imaginación, permitiéndote plasmar tus propios diseños o elegir entre nuestra exclusiva selección. Cada panel se convierte en una declaración de estilo personal y creatividad sin límites, invitándote a convertir cualquier espacio en una galería de expresión visual y compromiso ecológico.

ECOimagine  
ECOprint  
**Technical  
sheet — 199**





## ECOcustom

The ECOcustom range is the epitome of personalization in acoustic design. With panels you can cut, bevel, punch, and print as you desire, the possibilities are endless. Unleash your imagination and creativity to create spaces that are not only acoustically optimal but also aesthetically unique, reflecting your personal style and innovative vision.

La gama ECOcustom es el epítome de la personalización en diseño acústico. Con paneles que puedes cortar, biselar, troquelar e imprimir a tu antojo, las posibilidades son infinitas. Desata tu imaginación y creatividad para crear espacios que no solo son acústicamente óptimos, sino también estéticamente únicos, reflejando tu estilo personal y visión innovadora.

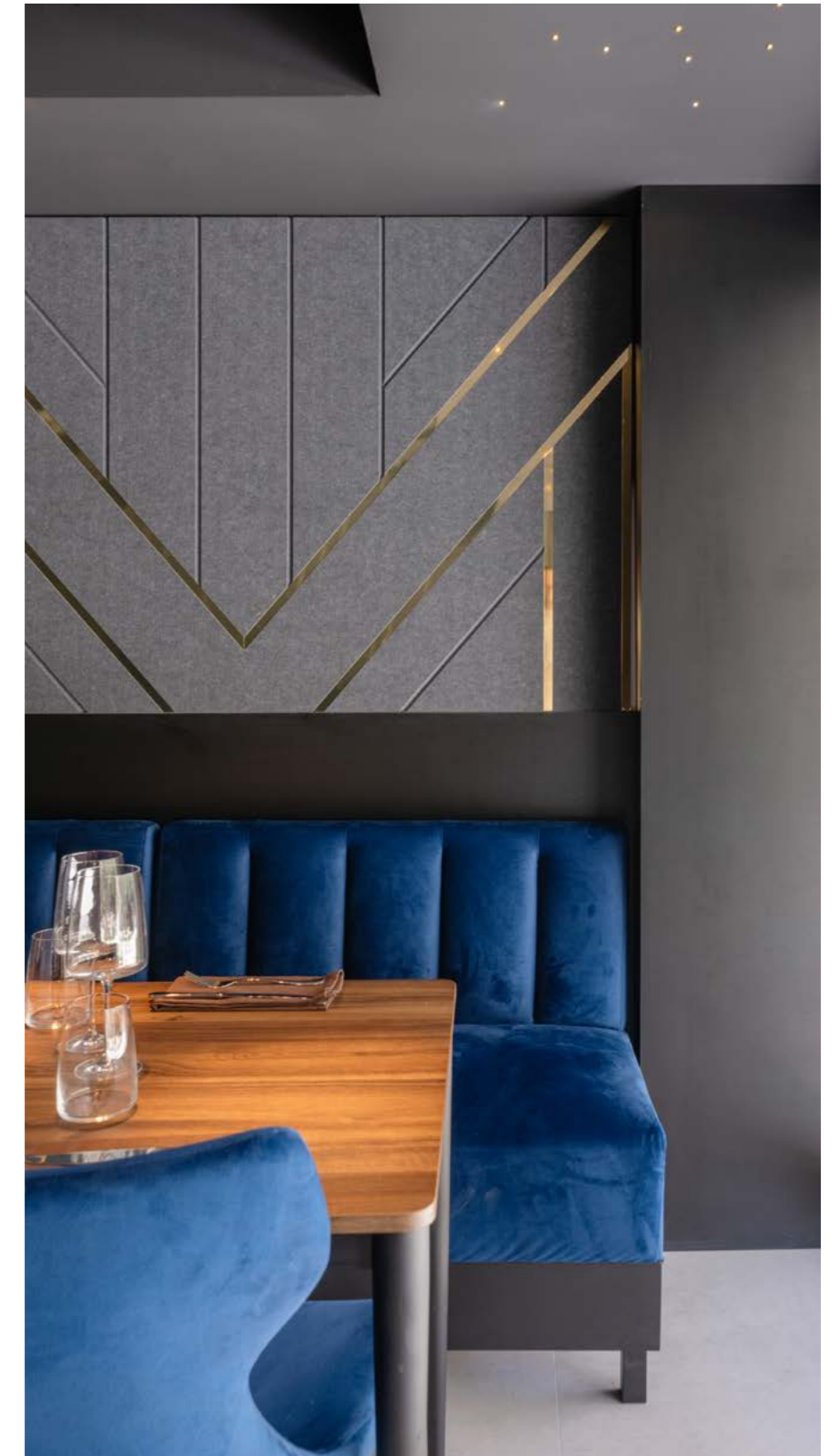

ECOcustom  
Colours — P211







## ECObooth

In serene solitude, we find a silent sanctuary, a cosmos of calm where the soul whispers secrets and the heart listens, embracing the peace of our own inner universe.

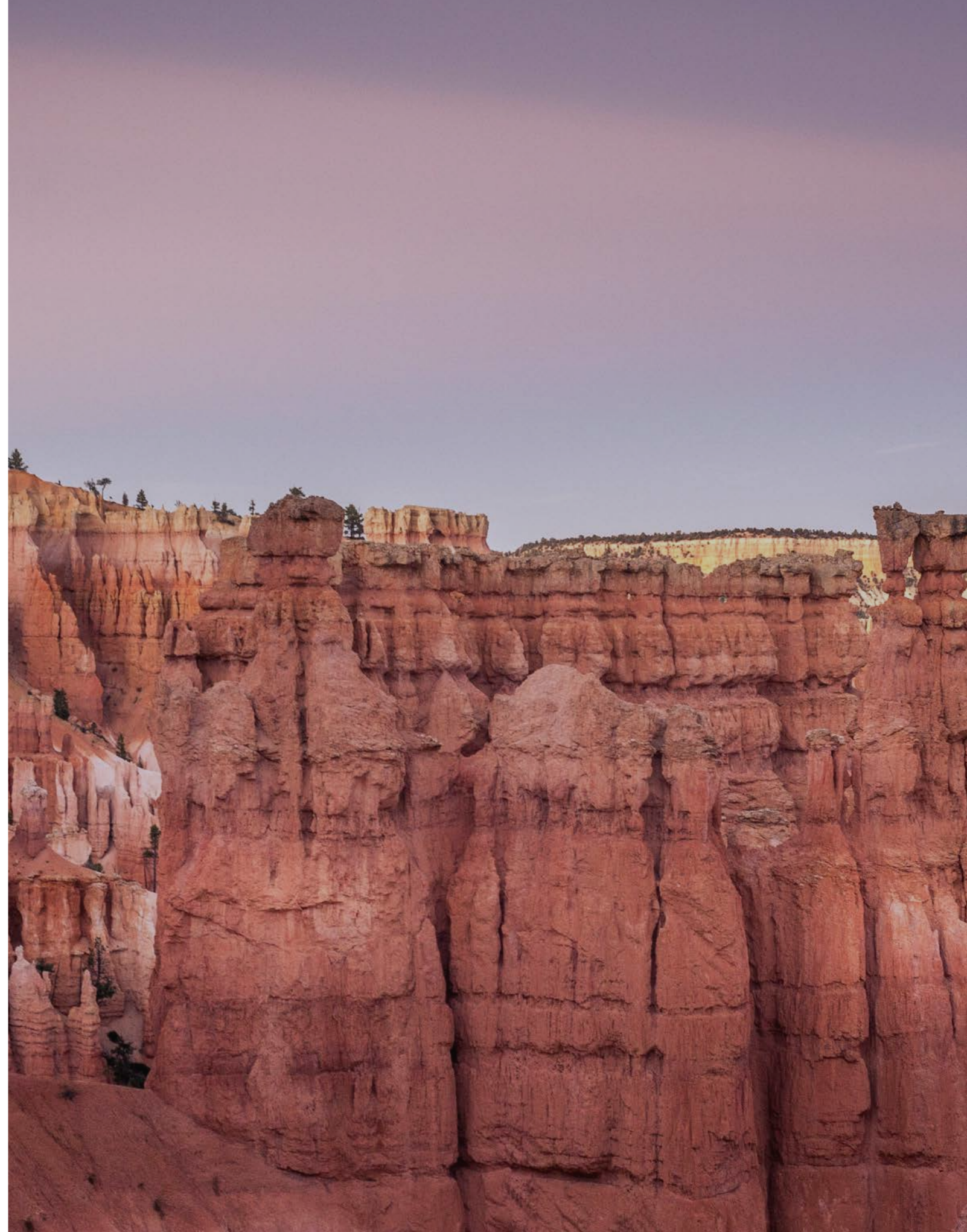



ECObooth  
Sweet home  
**Technical  
sheet — 206**  
Colours  
— P207



## Sweet home

Our acoustic booth blends design, comfort, and sustainability. The Sweet Home by ECOcero, optimized for concentration, enhances productivity and is easily installed in minutes, redefining the workspace with mobility and the finest acoustic technology.

Nuestra cabina acústica combina diseño, confort y sostenibilidad. La Sweet Home by ECOcero, optimizada para la concentración, mejora la productividad y se instala fácilmente en minutos, redefiniendo el espacio de trabajo con movilidad y la mejor tecnología acústica.



In the core of modern office design, ECOcero's Sweet Home acoustic cabins revolutionize the work environment by combining tranquility, concentration, and well-being. These cabins, merging functionality and aesthetics, offer an optimal workspace with advanced acoustics and eco-conscious design. More than just cabins, they are an investment in team happiness and creativity, reflecting a future of adaptable work committed to environmental care.

Las cabinas acústicas Sweet Home de ECOcero, en el núcleo del diseño de oficinas modernas, revolucionan el entorno laboral combinando tranquilidad, concentración y bienestar. Estas cabinas, que fusionan funcionalidad y estética, ofrecen un espacio laboral óptimo con su acústica avanzada y diseño eco-consciente. Son más que cabinas, son una inversión en la felicidad y creatividad del equipo, reflejando un futuro de trabajo adaptable y comprometido con el medio ambiente.

## **ECObasics**

In each wave that graces the shore lies the sea's embrace. It's a salty caress that, when broken, evokes tears and laughter, whispers tales of wandering whales, and arouses a sweet yearning for eternity.

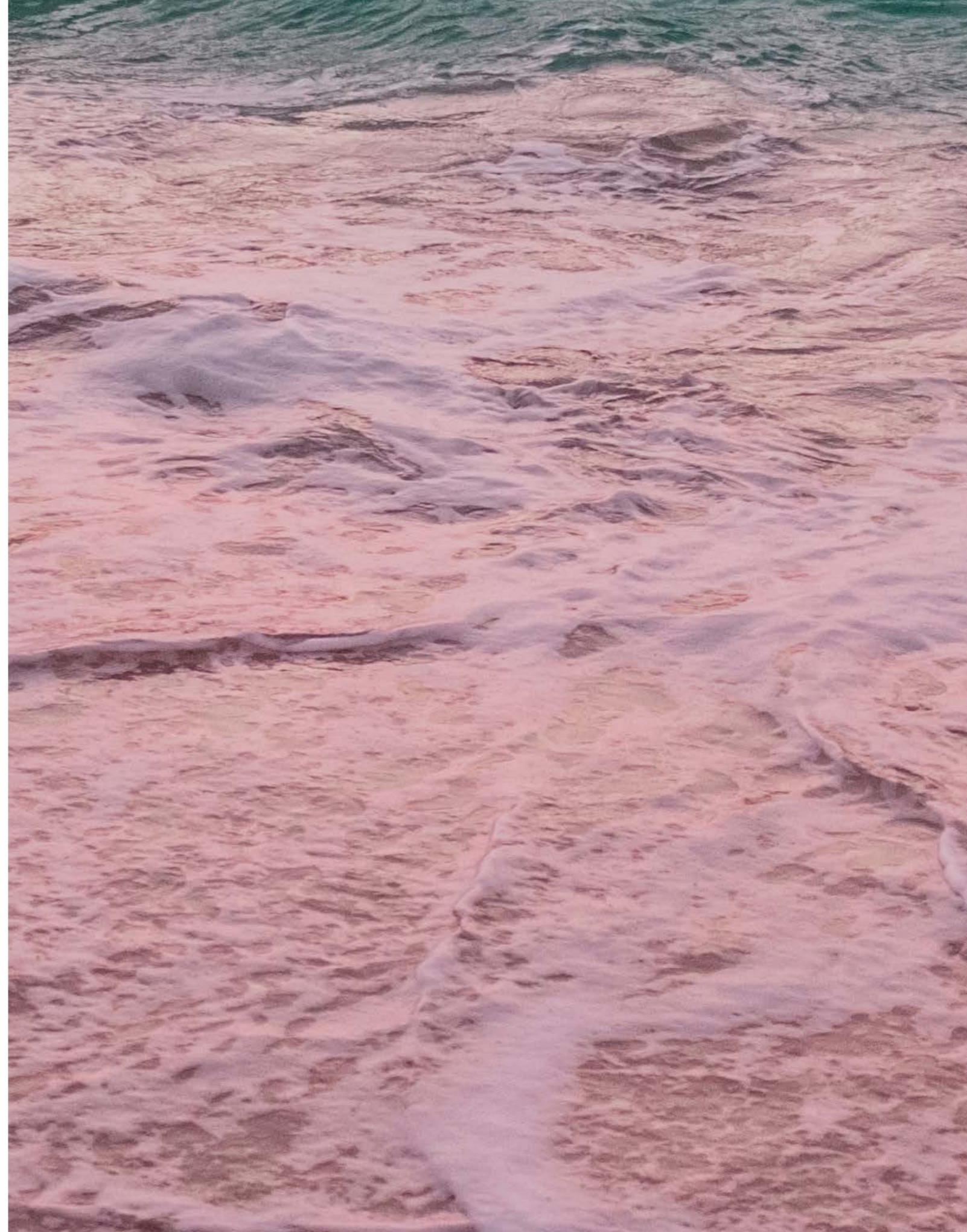

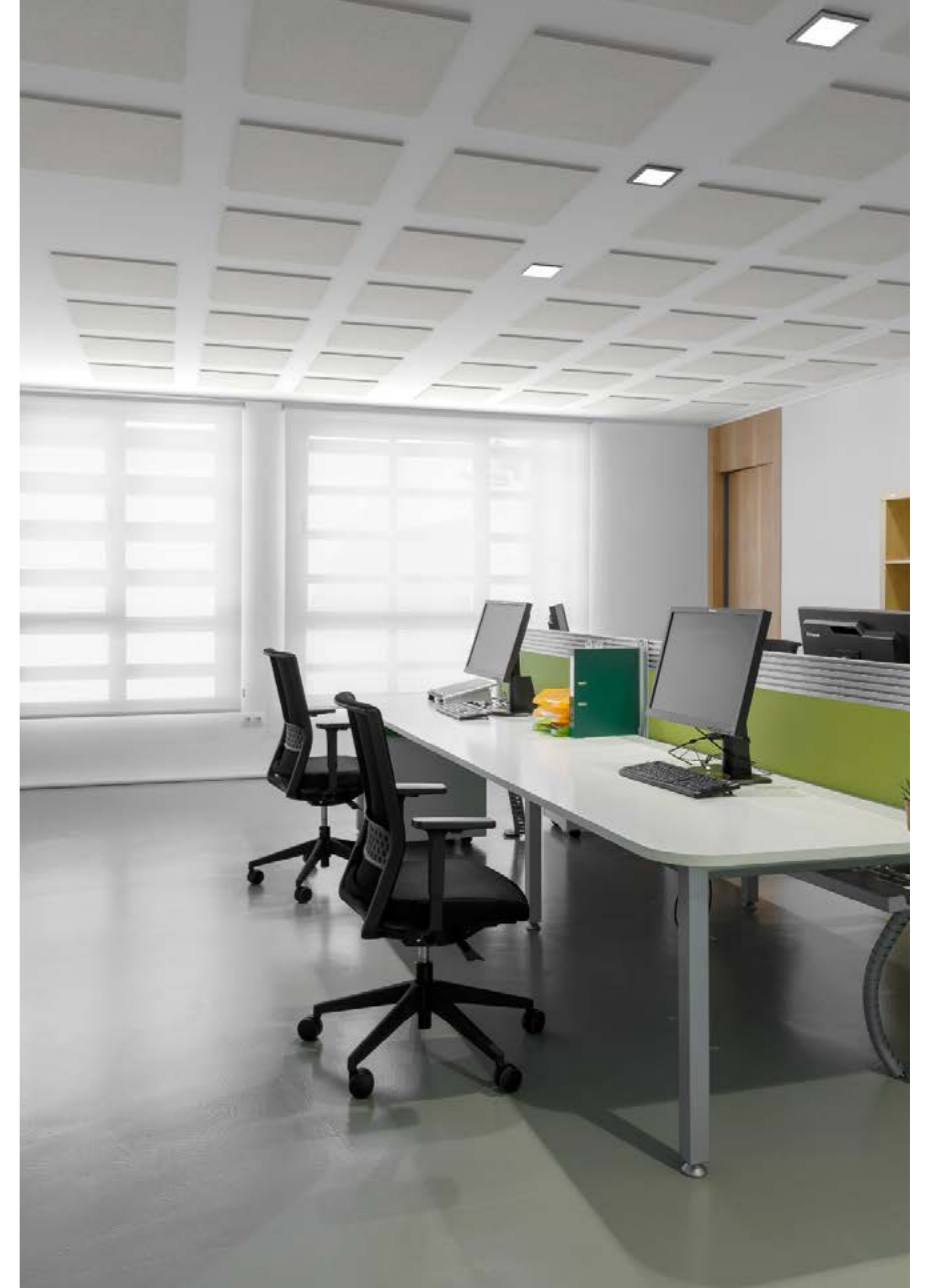

With a minimalist approach and simple shapes, they fit perfectly in any space. Their clean design, focused on the essence, stands out for its elegance, creating harmonious and timeless environments.

Con un enfoque minimalista y formas sencillas, encajan perfectamente en cualquier espacio. Su diseño limpio, centrado en la esencia, destaca por su elegancia, creando ambientes armoniosos y atemporales.

Technical  
sheet — P208-210  
**Colours — P211**

ECObasics  
Square  
**Technical  
sheet — 208**



## Square

Squares for walls and ceilings blend elegance and sobriety, with easy installation that enhances any space. Their pure design and geometric lines add a touch of discreet distinction, creating serene and timeless environments.

Cuadrados minimalistas para paredes y techos combinan elegancia y sobriedad, con un montaje sencillo que realza cualquier espacio. Su diseño puro y líneas geométricas aportan un toque de distinción discreta, creando ambientes serenos y atemporales.





## Circle

Circular designs for walls and ceilings offer elegance, design, and easy installation. Their shape and style bring sophistication and elegance to any space, fostering an atmosphere of calm and timeless beauty.

Diseños circulares minimalistas para paredes y techos ofrecen elegancia, diseño y una sencilla instalación. Su forma y estilo aportan sofisticación y elegancia a cualquier espacio, fomentando un ambiente de calma y belleza atemporal.

# Rectangle

Our minimalist rectangular designs for walls and ceilings are characterized by their elegance and ease of installation. Their linear shape and refined style bring modern sophistication to any space, creating an atmosphere of serenity and timeless beauty.

Nuestros diseños rectangulares minimalistas para paredes y techos destacan por su elegancia y facilidad de instalación. Su forma lineal y estilo refinado aportan una sofisticación moderna a cualquier espacio, creando un ambiente de serenidad y belleza atemporal.

ECObasics  
Rectangle  
**Technical**  
**sheet —210**



## **ECOdesign**

The excellence of art is like the first breath of dawn; a caress that whispers to the soul the unfathomable, inviting us to dance on the edge of dream and reality.

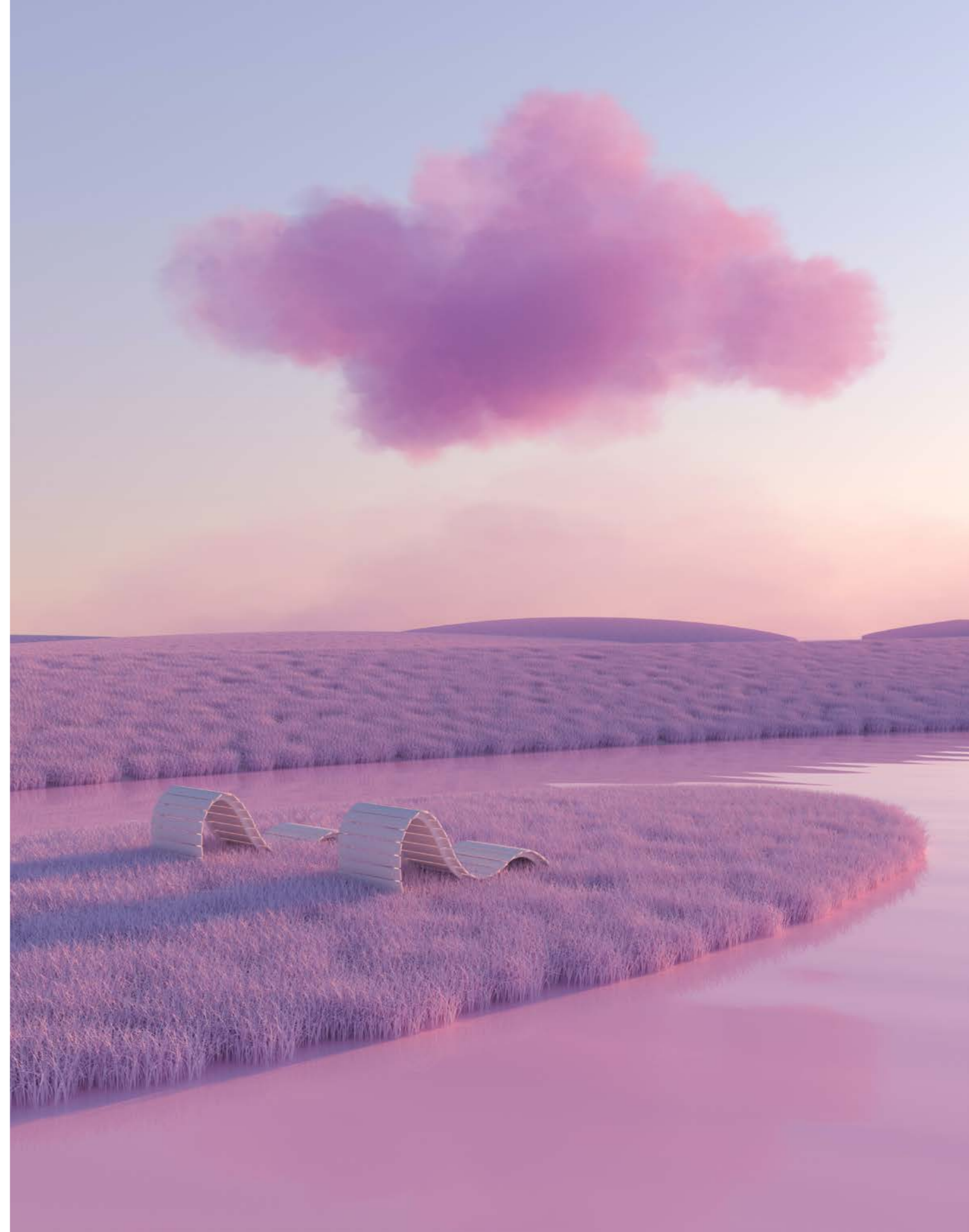





Masquespacio

### **What do you believe is the future of acoustics in design?**

The future lies in solutions carried out pre-construction and tailored to achieve a quick installation solution with a customized design.

### **What has been your source of inspiration when designing the collection for ECOcero?**

In the 2 products we have designed for ECOcero, we wanted to play with shapes and colors, creating different volumes. For the Puzzle design, the compositions of shapes in Rothko's works have been a clear inspiration.

### **What do you believe is the importance of acoustics in design?**

When it comes to functionality, acoustics and light must take center stage. A space can be beautiful and unique, but if there is poor acoustics or lighting, the user's comfort will be disrupted and may even deter them from a possible return visit to your establishment.

### **The importance of using sustainable materials in architecture.**

We, as designers and architects as the creators of projects, must be the first to offer sustainable materials, in order to create a better future. We have to be part of the change that the world needs to undergo environmentally to prevent a scenario where there is no tomorrow.

### **What benefits do we find in this collection?**

We think it reflects very well our ongoing search to create projects where fun is not far behind. We are here to create joy and without a doubt, the designs we have done for Ecocero carry that identity of ours.

### **What does good design mean to you?**

A good design is one that has its functionality, while also generating a unique sensation for its user. It's like a feeling that makes you smile internally without you being aware of it.



## Optical Illusion

Captivating and immersive piece of art that will leave you in awe of its mesmerizing beauty. Crafted with precision and expertise, this unique creation is meticulously designed using acoustic panels, ensuring that every detail is executed flawlessly.

As you approach this creation from different angles, it transports you to a world where reality and illusion intertwine perfectly. Your vision will be enchanted as the optical illusion gracefully dances before your eyes, playing with your perception and challenging your senses. Every intricate detail has been carefully incorporated to enhance the charm, creating an immersive experience like no other.

Cautivadora e inmersiva obra de arte que te dejará maravillado por su belleza hipnotizante. Cuidadosamente elaborada con precisión y experiencia, esta creación única está diseñada meticulosamente utilizando paneles acústicos, asegurando que cada detalle sea ejecutado impecablemente.

A medida que te acercas a esta creación desde diferentes ángulos, te transportará a un mundo donde la realidad y la ilusión se entrelazan de manera perfecta. Tu visión quedará encantada mientras la ilusión óptica danza con gracia ante tus ojos, jugando con tu percepción y desafiando tus sentidos. Cada detalle intrincado ha sido cuidadosamente incorporado para realzar el encanto, creando una experiencia inmersiva como ninguna otra.

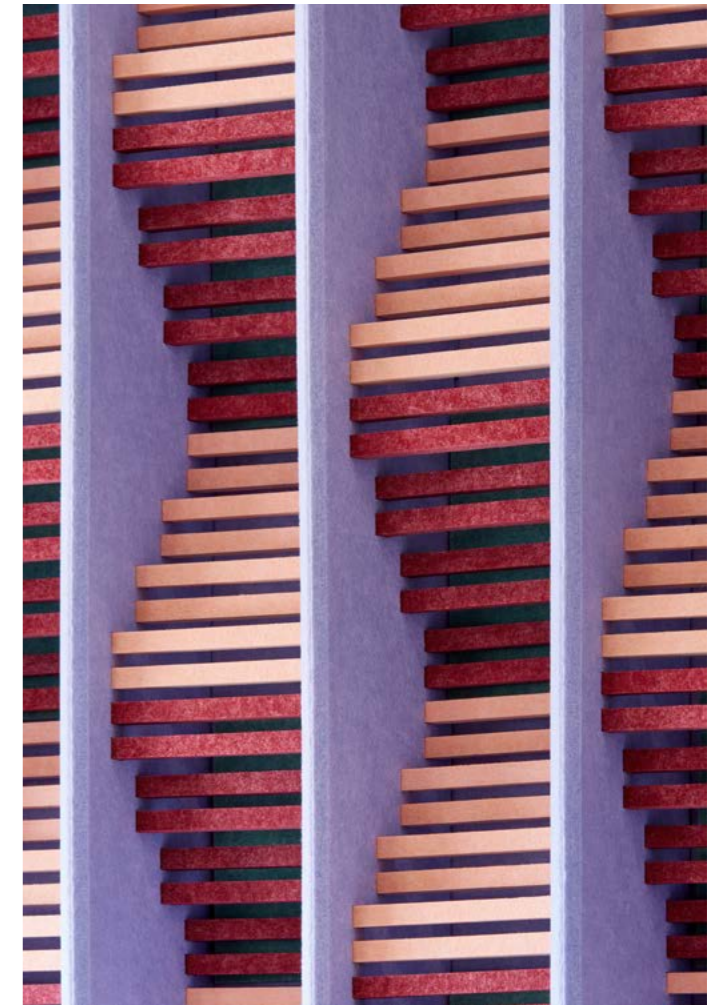

All profits from  
Optical Illusion  
will go to:

Todos los beneficios  
de Optical Illusion  
irán destinados a:



Arquitectos Sin Fronteras drives social justice and development in 12 countries, addressing exclusion and poverty through housing, education, health, and accessibility.

Arquitectos sin Fronteras impulsa la justicia social y el desarrollo en 12 países, abordando exclusión y pobreza mediante vivienda, educación, salud, y accesibilidad.



Alejandra  
Pombo

**What do you think the future of acoustics in design is?**

The future of acoustics in design will likely include technological advances and innovative approaches to integrate acoustic solutions more efficiently and aesthetically into spaces. The demand for quiet and comfortable environments will continue to be a priority, which could lead to the creation of more advanced materials and techniques for soundproofing.

**What has been your source of inspiration when designing the collection for ECOcero?**

The three collections are inspired by the postmodern design of the 70s, where there was a shift in design towards something more authentic, more personal, messier, with character, organic shapes, and retro inspiration. They represent a reaction against the purified modernism of mid-century, in favor of “playful embellishment and radical experimentation with form.” Personal expression and individuality were

the hallmarks of the era. The 3 collections are characterized by being fun and asymmetric patterns, bold and “explosive” colors with the aim of innovating in the application of ECOcero material.

**What do you think is the importance of acoustics in design?**

Acoustics is essential in design because it directly affects the experience and comfort of the occupants of a space. Good acoustic design can improve quality of life by reducing unwanted noise, creating more relaxing environments, and enhancing productivity in work settings.

**The importance of using sustainable materials in architecture.**

The use of sustainable materials in architecture is crucial to reducing environmental impact and promoting environmental responsibility. Sustainable materials not only benefit the environment but can also contribute to energy efficiency and improve indoor air quality.

**What benefits do we find in this collection**

It can offer benefits such as functionality, aesthetics, sustainability, and possibly, innovative solutions in acoustics.

**What does good design mean to you?**

Good design, in general terms, balances functionality, aesthetics, and efficiency. It must meet the needs of the client, enhance the user experience, and consider practical and aesthetic aspects. Attention to sustainability and innovation is also often an important component in contemporary design.



## Quibble

Inspired by the postmodernist design of the 1970s, where there was a shift towards something more authentic, more personal, more chaotic, with character, organic shapes, and retro inspiration. They represent a reaction against the mid-century purist modernism, in favor of “playful embellishment and radical experimentation with form.” Personal expression and individuality were the hallmarks of the era. The three collections are characterized by fun and asymmetrical patterns, bold and “explosive” colors to innovate in the application of ECO-cero material.

Inspiradas en el diseño posmodernista de los años 70, donde se produjo un cambio en el diseño hacia algo más auténtico, más personal, más desordenado, con carácter, formas orgánicas e inspiración retro. Representan una reacción contra el modernismo purificado de mediados de siglo, a favor del “embellecimiento lúdico y la experimentación radical con la forma”. La expresión personal y la individualidad eran las señas de identidad de la época. Las 3 colecciones se caracterizan por ser Patrones divertidos y asimétricos, Colores atrevidos y “explosivos” con el fin de innovar en la aplicación del material de ECOcero.



All profits from Quibble will go to:

## KUBUKA

Todos los beneficios de Quibble irán destinados a:

Kubuka works in Kenya and Zambia to create sustainable development, focusing on education and entrepreneurship. They are currently developing a community development project through recycling in Kibera (Nairobi).

Kubuka trabaja en Kenia y Zambia para crear desarrollo sostenible, enfocándose en educación y emprendimiento. Actualmente desarrolla un proyecto de desarrollo comunitario a través del reciclaje en Kibera (Nairobi).



# The Room Studio

## **What do you believe is the future of acoustics in design?**

At The Room Studio, we believe the future of acoustic design lies in the integration of attractive solutions that blend aesthetics and lighting. This applies not just to office environments, but also to homes and commercial premises. We envision acoustic solutions with integrated design that are used not only for their acoustic function but also for their aesthetic appeal.

## **What has been your source of inspiration when designing the collection for ECOcero?**

Our main source of inspiration for designing the Lumomesh collection for ECOcero was the fusion between lighting and integrated design. We aimed to create organic shapes and defined patterns that, when combined, would generate distinctive structures. The light itself was our primary inspiration.

## **What do you believe is the importance of acoustics in design?**

The importance of acoustics in design lies in the creation of acoustically well-defined spaces without compromising aesthetics or user experience. Good acoustics improve quality of life, contribute to well-being, and enrich the environment. This aspect is crucial in all areas, as we mentioned before, not only in work environments but in any habitable space, with the goal of achieving integral harmony.

## **The importance of using sustainable materials in architecture.**

The importance of using sustainable materials in architecture is fundamental. Considering all elements when creating a project is essential to minimize environmental impact, reduce waste, and promote healthier environments. At The Room Studio, we are passionate about creating sustainable environments through home automation, while designing unique and personalized spaces with a reduced environmental footprint.

## **What benefits do we find in this collection?**

The benefits of our Lumomesh collection are diverse and significant. It is a collection of innovative panels that uniquely fuse acoustics, lighting, and design, offering the possibility of total customization. These panels allow for optimal soundproofing without sacrificing the warmth of lighting, resulting in unique spaces and cozy atmospheres. Whether on walls, ceilings, or in details like soffits, Lumomesh allows us to create environments with indirect light, full of elegance and timelessness.

## **What does good design mean to you?**

For us, good design transcends mere aesthetics; it must be functional, innovative, and sustainable. It should enhance people's lives and their well-being. Good design endures over time and adapts to changes and needs. Moreover, it lays the foundation to complement the space with other elements that are in harmony with its essence.



## Mirage

Striking work of art that redefines aesthetics. With dimensions of 150 x 150, this piece masterfully plays with reality through its black and white palette. The rounded and rectangular shapes create an illusion of depth, while the contrast between pure white and deep black highlights timeless elegance. Designed to complement any space, Mirage is more than a piece of art; it is an experience that invites reflection. In its stillness, this work transcends the conventional, turning any environment into a captivating and poetic stage.

Impactante obra de arte que redefine la estética. Con dimensiones de 150 x 150, esta pieza juega magistralmente con la realidad a través de su paleta en blanco y negro. Las formas redondeadas y rectangulares crean una ilusión de profundidad, mientras que el contraste entre el blanco puro y el negro profundo resalta la elegancia atemporal. Diseñado para complementar cualquier espacio, Mirage es más que una obra de arte; es una experiencia que invita a la reflexión. En su quietud, esta obra trasciende lo convencional, convirtiendo cualquier entorno en un escenario cautivante y poético.

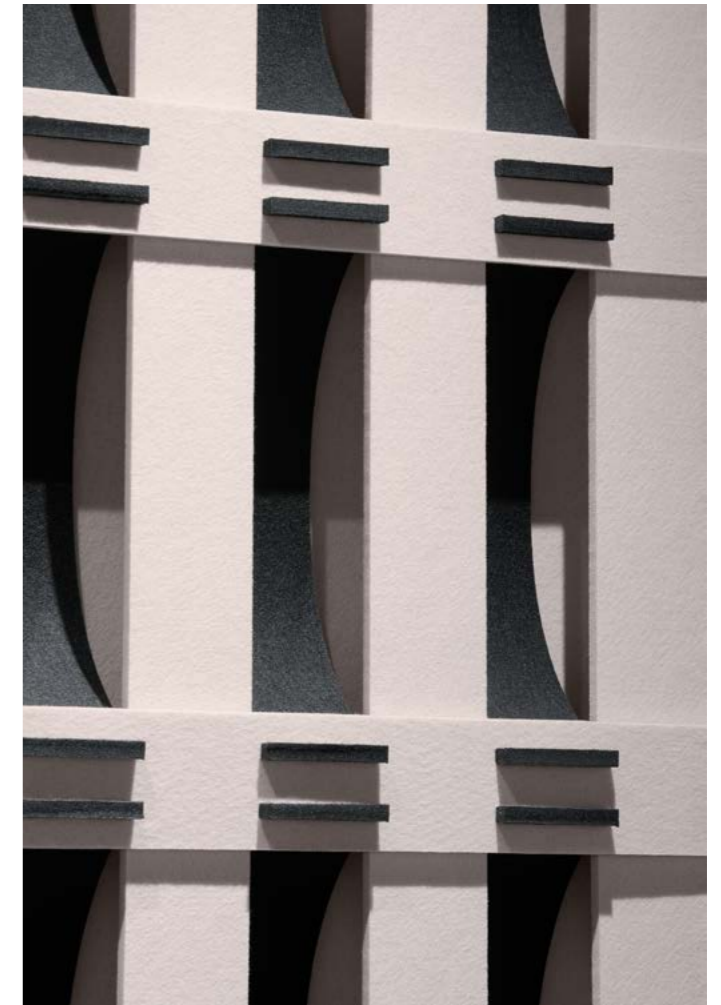

All profits from Mirage will go to:



Todos los beneficios de Mirage irán destinados a:

An international non-governmental organization that provides emergency and long-term medical care to vulnerable populations, and advocates for equal access to healthcare worldwide.

Organización no gubernamental de carácter internacional que proporciona atención médica de emergencia y de largo plazo para poblaciones vulnerables, y defiende la igualdad de acceso a la asistencia sanitaria en todo el mundo.



Noé  
Prades

### **What do you think is the future of acoustics in design?**

Acoustics is increasingly playing a more important role in spaces, generating comfort with a strong commitment to creating atmospheres with technological advances and innovative approaches that seek to improve sound quality and auditory experience in various environments. The future of acoustics in design will likely be marked by the convergence of technology, aesthetics, and functionality, focusing on improving the quality of life and user experience through more advanced sound solutions.

### **What has been your source of inspiration when designing the collection for ECOcero?**

The BEATS collection of luminaires represents in form the sound of the wind (The BREZZE lamp) and the sound of the hummingbird's song (The COLIBRI lamp). The inspiration for this project has been nature itself. How sounds affect our senses and how to transfer this concept into sculptural lamps that represent the natural sounds that surround us.

### **What do you think is the importance of acoustics in design?**

Acoustics plays a fundamental role in the design of various environments and products, and its importance extends to several areas. In environments such as homes, offices, concert halls, and public spaces, acoustic quality directly affects the user's experience. Good acoustic design can improve sound quality, reduce unwanted noise, and create pleasant environments, improving health and well-being as well as enhancing concentration and work performance.

### **The importance of using sustainable materials in architecture.**

The use of sustainable materials in architecture is becoming increasingly relevant due to their significant impact on the environment. The use of sustainable materials aims to minimize these impacts, promoting the conservation of resources and reducing the environmental footprint. This is essential in the context of growing global awareness of the importance of addressing

environmental challenges. We, as designers, must commit and be the drivers to promote and apply these types of materials in spaces.

### **What benefits do we find in this collection?**

The main advantage of the BEATS collection is its ability to absorb or diffuse sound, thus contributing to improving the acoustic quality of a space. This collection has been designed to combine aesthetics and functionality. By integrating lighting with acoustic properties, these lamps serve multiple functions, providing both light and improvements in acoustics in a sculptural form.

### **What does good design mean to you?**

To me, good design must cover four main points: Functionality, sustainability, innovation, and aesthetics. In general, good design seeks a balance through a concept to create functional, aesthetic spaces or products and effectively create experiences for the user.



## Waves

An acoustic panel that is part of the Beats collection, composed of various slats from the ECO panel with shapes that mimic ocean waves. This innovative design not only enhances the acoustic quality of the space but also adds a visual element that evokes the serenity of the ocean.

Un cuadro acústico que forma parte de la colección Beats, compuesto por diferentes lamas del panel ECO con formas que imitan las olas del mar. Este innovador diseño no solo mejora la acústica del espacio, sino que también agrega un elemento visual que evoca la serenidad del océano.

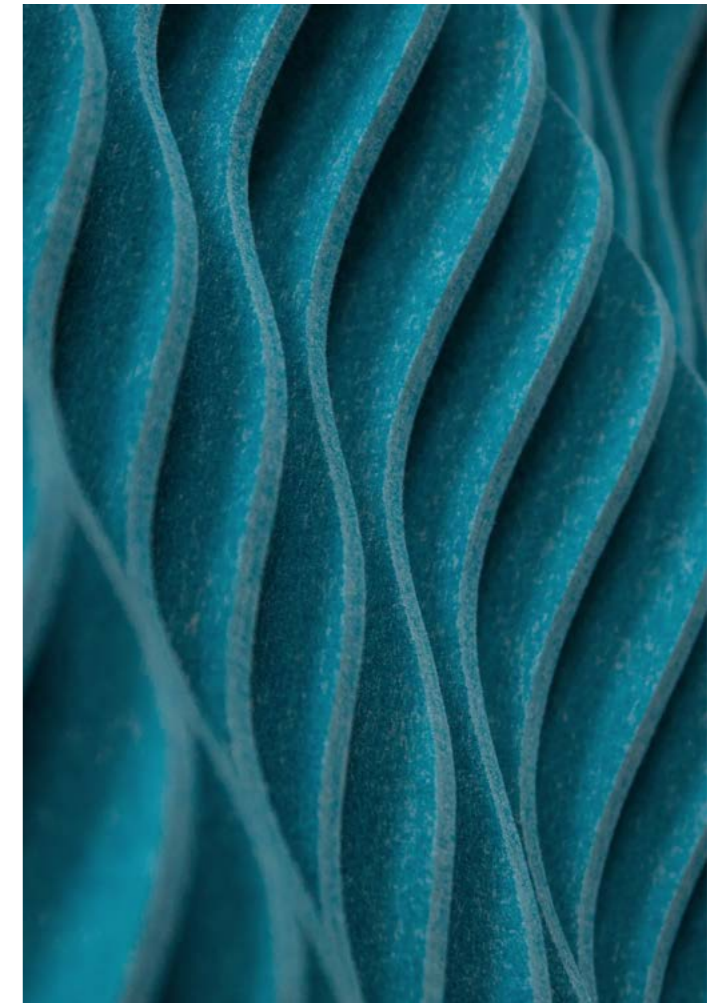

All profits from Waves will go to:



Todos los beneficios de Waves irán destinados a:

Develops educational and life experiences for children aged 3 to 12, aimed at compensating for the academic, personal, and social inequalities they suffer, so that they can develop their individual talents and civic competencies.

Desarrolla experiencias educativas y vitales a niños y niñas de 3 a 12 años, orientadas a compensar las desigualdades académicas, personales y sociales que padecen, de modo que puedan desarrollar sus talentos individuales y competencias ciudadanas.





Erico  
Navazo

**What do you think is the future of acoustics in design?**

Interior spaces must be not only beautiful but also comfortable; acoustic comfort is as crucial as ergonomics or good lighting in spaces.

**What has been your source of inspiration when designing the collection for ECOcero?**

Nature is always my great source of inspiration, with colors and textures that I fall in love with.

**What do you think is the importance of acoustics in design?**

Acoustics in design is key. It is essential for creating environments that not only look good but also feel good to be in, enhancing the overall user experience through sound management.

**The importance of using sustainable materials in architecture.**

Responsible consumption and the use of sustainable materials in architecture and interior design are crucial. Taking care of the environment is our responsibility, and integrating sustainable practices into our designs is part of that commitment.

**What benefits do we find in this collection?**

The ability to create acoustically comfortable, beautiful, and special spaces. This collection offers solutions that cater to the aesthetic and functional needs of modern spaces, emphasizing acoustic comfort without compromising on style.

**What does good design mean to you?**

A good design is one that combines functionality and beauty. It should meet the needs of its users while also providing an aesthetically pleasing experience, reflecting a balance between practicality and visual appeal.



## Over

The creation of Over has been inspired by the saltwater lagoons found in privileged natural areas, such as the Mata Lagoons in Alicante, Lake Hillier in Australia, or Lake Masazir in Azerbaijan, where freshwater mixes with land influenced by high salt content and habitats associated with low relief. The course of freshwater mixes with mineral sediments, organisms, and algae that inhabit the interior, shaping the striking colors of these lagoons, which, depending on the time of year, can appear in shades of pink. Thus, the blend of fine sand, lagoon water, seawater, and the dark green of the woods, along with the brand's sustainable commitment, serves as the inspiration for the Over series.

La creación de Over se ha inspirado en las lagunas saladas que se dan en zonas privilegiadas de la naturaleza, como las lagunas de la Mata en Alicante, el lago Hillier en Australia o el lago Masazir en Azerbaiyán, donde el agua se mezcla con el medio terrestre afectado por alto contenido en sales y por hábitats ligados a relieves bajos. El curso del agua dulce se mezcla con los sedimentos minerales, organismos y algas que habitan en el interior y van conformando los colores de estas lagunas tan llamativas, que, según las épocas del año se pueden ver de colores rosas. Así pues, la mezcla de la arena fina, el agua de la laguna, el agua del mar y el verde oscuro de la arboleda y el compromiso sostenible de la marca, son la inspiración para la serie Over.



All profits from Over will go to:

Todos los beneficios de Over irán destinados a:

**NJOVU**  
African Wildlife Conservation

A Zambian-Spanish non-profit organization dedicated to the conservation of African biodiversity and wildlife.

Organización sin ánimo de lucro zambiano-española dedicada a la conservación de la biodiversidad y fauna salvaje africana.

# Technical specifications



## EColine certificate (PET)



LEED® Certificate (Pass)



BREEAM® Certificate (Exemplary level)



Green Building Council USGBC



FSC STANDARD for Chain of Custody Certification



VOCs Certificate (A+ classification)



Acoustic Absorption Certification



CE Certified (EN 15102:2007 + A1:2011)



GLOBAL RECYCLED STANDARD Certificate  
(Minimum 60% Post-consumer)



PEFC Certificate ( ST 2002:2013)



OEKO-TEX STANDARD 100 Certificate

Recycled textile fibre  
Maximum panel dimension:  
2340x1170 mm.

High acoustic absorption

Surface density:  
9 mm: 1500 g/m<sup>2</sup>  
12mm: 2400 g/m<sup>2</sup>  
24 mm: 4000 g/m<sup>2</sup>

Thermal conductivity:  
0,040 W/(m\*k)

Thermal resistance:  
0,621 m<sup>2</sup>\*K/W

Fire resistance: B,s1, d0  
Fireproof  
Suitable for use  
in public areas

# Made in Spain

In ECOcero, we understand the importance of local production and the value this adds to our products and services. Therefore, we offer our clients the option to guarantee that their acoustic panels are 100% Made in Spain. This option not only reflects our commitment to quality and local craftsmanship but also supports the Spanish economy and reduces the carbon footprint associated with transportation. By choosing this option, our clients benefit from the excellence in manufacturing and design that Spain offers, ensuring that each panel not only meets the highest standards of sustainability and functionality but also carries with it the rich heritage and artisanal care of our country.

En ECOcero, entendemos la importancia de la producción local y el valor que esto añade a nuestros productos y servicios. Por ello, ofrecemos a nuestros clientes la opción de garantizar que sus paneles acústicos sean 100% Made in Spain. Esta opción no solo refleja nuestro compromiso con la calidad y la artesanía local, sino que también apoya la economía española y reduce la huella de carbono asociada al transporte. Al elegir esta opción, nuestros clientes se benefician de la excelencia en manufactura y diseño que España ofrece, asegurando que cada panel no solo cumple con los más altos estándares de sostenibilidad y funcionalidad, sino que también lleva consigo la rica herencia y el cuidado artesanal de nuestro país.

# Groovy by Alejandra Pombo

ECOWall

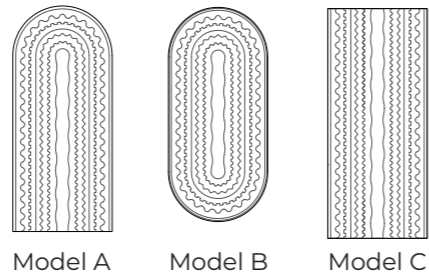

Model A Model B Model C

## Product description

The Groovy model by Alejandra Pombo is a recycled polyester fiber acoustic panel from the ECOcero brand. The panel dimensions are 2360x1020 mm with a thickness of 27 mm (9+9+9 mm), composed of 3 panels of 9 mm each. It is available in 3 models for creating customized compositions. The panel is fixed using adhesive from the ECOcero brand. Available in 16 base colors. It holds GOLD certification, FSC STANDARD, LEED, BREEAM, GLOBAL RECYCLED STANDARD, PEFC (ST 2002:2013), and OEKO-TEX STANDARD 100 certifications.

Panel acústico de fibra de poliéster reciclado de la marca ECOcero modelo Groovy by Alejandra Pombo. Dimensión de panel 2360x1020 mm, espesor 27 mm (9+9+9 mm), compuesto por 3 paneles de 9 mm cada uno. Disponible en 3 modelos para poder realizar composiciones personalizadas. Fijación mediante adhesivo de la marca ECOcero. Disponible en 16 colores base. GOLD certification, FSC STANDARD, LEED, BREEAM, GLOBAL RECYCLED STANDARD, PEFC (ST 2002:2013), and OEKO-TEX STANDARD 100.

## Absorption coefficient

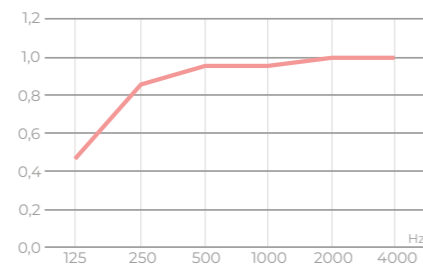

## Available thickness

— 27 mm (9+9+9)

## Available Sizes

	Height	Width	Surface
<b>A</b>	2317mm	1020mm	2,25m <sup>2</sup>
<b>B</b>	2200mm	1020mm	2,40m <sup>2</sup>
<b>C</b>	2360mm	1020mm	2,02m <sup>2</sup>

## Technical sheet

### Composition

Recycled textile fiber.

**Weight approx Model A:** 10 kg  
**Weight approx Model B:** 9,0 kg  
**Weight approx Model C:** 10,5 kg

### Absorption

No air chamber  
 (αw 0.5)  
 NCR= 0.7  
 Air chamber 200 mm  
 (αw 1)  
 NCR= 0.95

### Cutting tolerance

± 2 mm

### Fire resistance

B-s1-d0. Flame retardant.  
 for public place.

# Strata by Erico Navazo

ECOWall

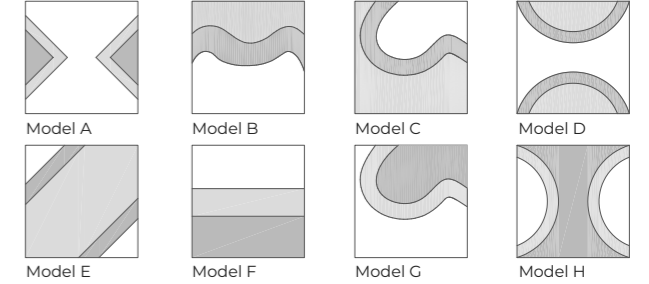
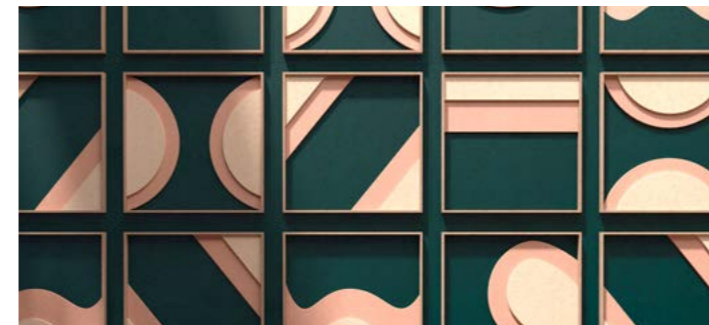

Model A Model B Model C Model D  
 Model E Model F Model G Model H

## Product description

The Strata model by Erico Navazo is a recycled polyester fiber acoustic panel from the ECOcero brand. The unit dimensions are 585x585 mm with a depth of 36 mm, composed of 3 panels of 9 mm. The panel is fixed using ECOcero brand adhesive for direct attachment to the support. It is available in a monochrome option and a tricolor option (supplied in a pack of 8 units). Available in 16 base colors. It holds GOLD, FSC STANDARD, LEED, BREEAM, GLOBAL RECYCLED STANDARD, PEFC (ST 2002:2013), and OEKO-TEX STANDARD 100 certifications.

Panel acústico de fibra de poliéster reciclado de la marca ECOcero modelo Strata by Erico Navazo. Dimensiones de la unidad 585x585 mm por una profundidad de 36 mm, compuesto por 3 paneles de 9 mm. Fijación mediante adhesivo de la marca ECOcero para fijación directa a soporte. Disponible en opción monocolor y tricolor (suministrado en pack de 8 ud). Disponible en 16 colores base. GOLD, FSC STANDARD, LEED, BREEAM, GLOBAL RECYCLED STANDARD, PEFC (ST 2002:2013) y OEKO-TEX STANDARD 100.

## Absorption coefficient

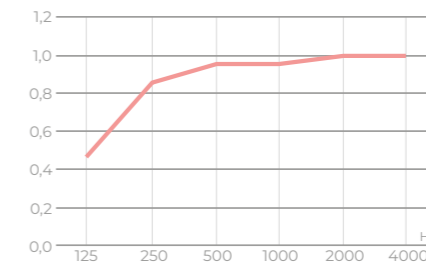

## Available thickness

— 27 mm (9+9+9)

## Available Sizes

Volume 1 U. 585 x 585x 36 mm  
 Composition surface 2,74m<sup>2</sup>

## Technical sheet

### Composition

Recycled textile fiber.

**Weight approx 1 UD.**  
 1,12 kg

### Absorption

No air chamber  
 (αw 0.5)  
 NCR= 0.7  
 Air chamber 200 mm  
 (αw 1)  
 NCR= 0.95

### Cutting tolerance

± 2 mm

### Fire resistance

B-s1-d0. Flame retardant.  
 for public place.

# V-cut

ECOWall



## Product description

The VCUT is a recycled polyester fiber acoustic panel from the ECO range of ECOcero, model ECOWall v-cut, available in catalog or customized designs, with dimensions of 2340x1170 mm and a thickness of 12 mm. It includes a system for fixation using contact adhesive from the ECOcero brand for direct attachment to support. Available in 16 base colors. It is CE marked and certified with GOLD, FSC STANDARD, LEED, BREEAM, GLOBAL RECYCLED STANDARD, PEFC (ST 2002:2013), and OEKO-TEX STANDARD 100.

Panel acústico de fibra de poliéster reciclada gama ECO de ECOcero, modelo ECOWall v-cut, diseño de catálogo o personalizado, de medidas 2340x1170 mm, espesor 12 mm. Incluida p/p de sistema de fijación mediante cola de contacto de la marca ECOcero para fijación directa a soporte. Disponible en 16 colores base. Marcado CE, con certificado GOLD, FSC STANDARD, LEED, BREEAM, GLOBAL RECYCLED STANDARD, PEFC (ST 2002:2013) y OEKO-TEX STANDARD 100.

## Absorption coefficient

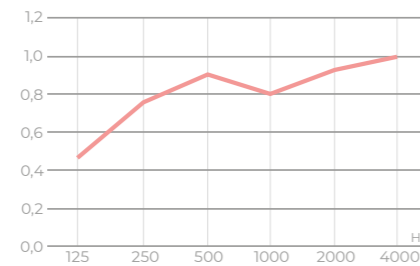

## Available thickness

— 12 mm

## Available Sizes

2340 mm x 1170 mm. Customized.

## Technical sheet

**Composition**  
Recycled textile fiber.

**Weight approx**  
6,50 Kg

**Absorption**  
No air chamber ( $\alpha_w$  0.3)  
NCR= 0.45  
Air chamber 50 mm ( $\alpha_w$  0.75)  
NCR= 0.8  
Air chamber 200 mm: ( $\alpha_w$  0.9)  
NRC= 0.85

**Cutting tolerance**  
 $\pm$  2 mm

**Fire resistance**  
B-s1-d0. Flame retardant. for public place.

## ECOWall | V-cut

### New

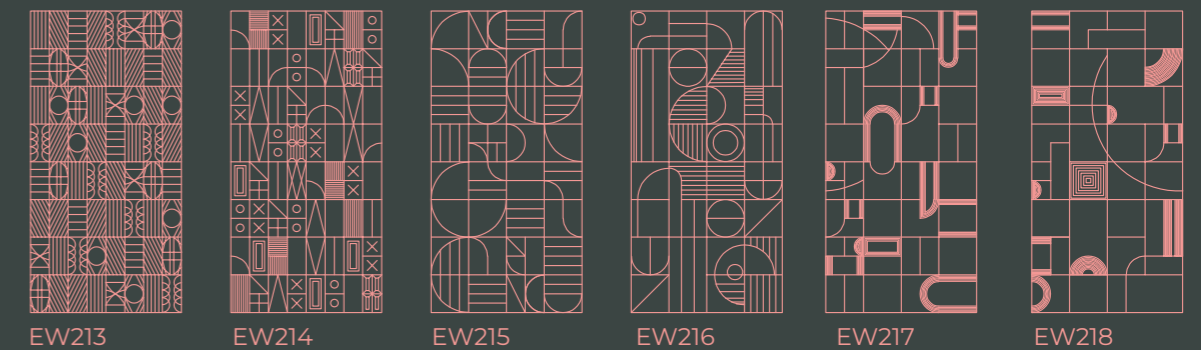
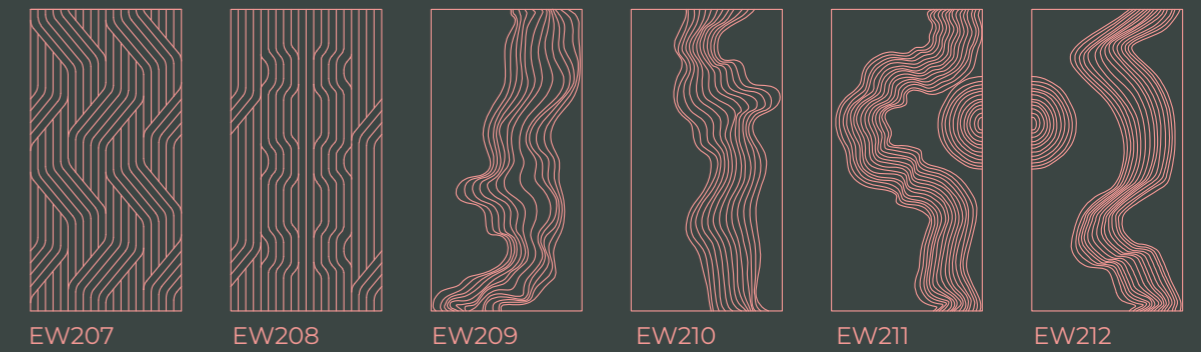
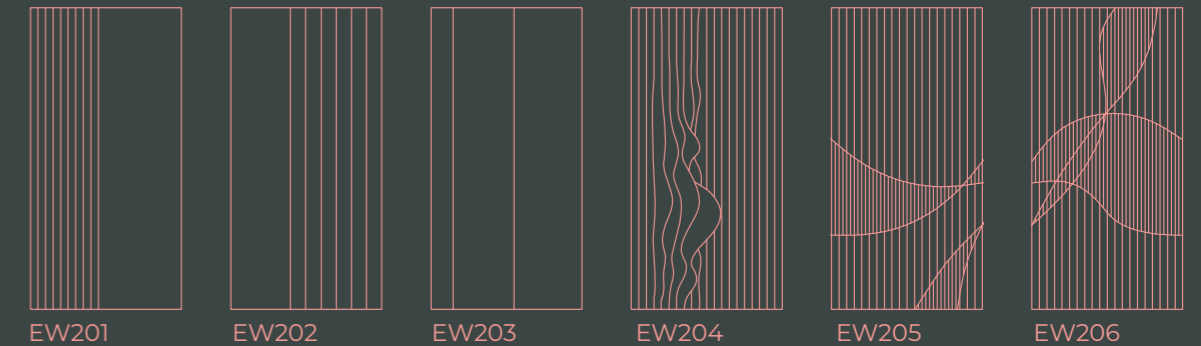

### Classic

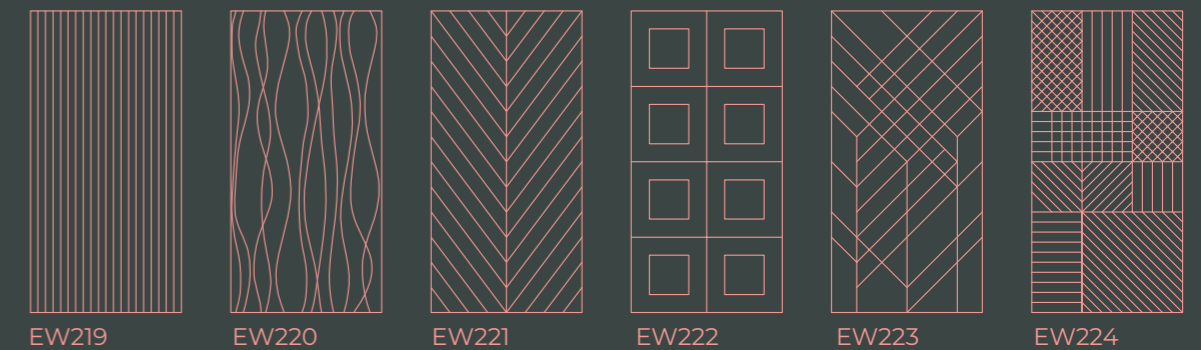

# Volume

ECOWall

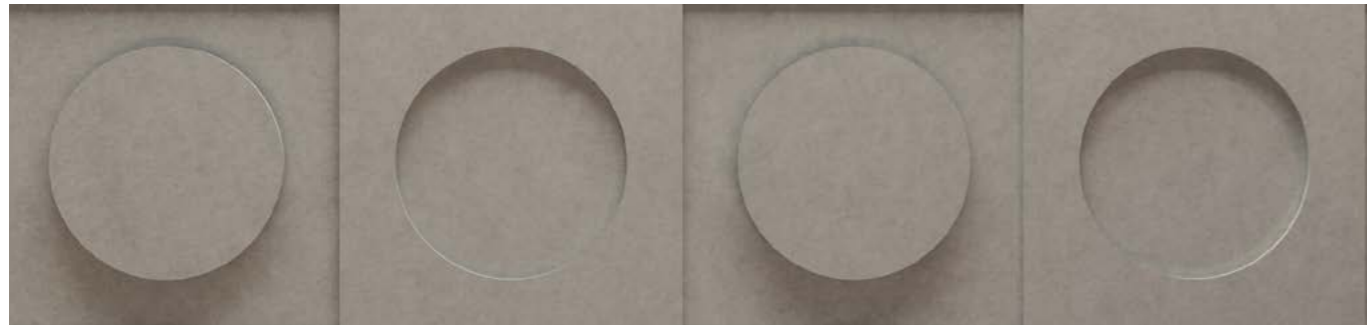

## Product description

The VOLUME is a recycled polyester fiber acoustic panel from the ECO range of ECOcero, model ECOWall volume, available in catalog or customized designs, with dimensions of 2340x1170 mm and a thickness of 18 mm (9+9 mm). It includes a system for fixation using contact adhesive from the ECOcero brand for direct attachment to support. Available in 16 base colors. It is CE marked and certified with GOLD, FSC STANDARD, LEED, BREEAM, GLOBAL RECYCLED STANDARD, PEFC (ST 2002:2013), and OEKO-TEX STANDARD 100.

Panel acústico de fibra de poliéster reciclada gama ECO de ECOcero, modelo ECOWall volumen, diseño de catálogo o personalizado, de medidas 2340x1170 mm, espesor 18 mm (9+9 mm). Incluye p/p de sistema de fijación mediante cola de contacto de la marca ECOcero para fijación directa a soporte. Disponible en 16 colores base. Marcado CE, con certificado GOLD, FSC STANDARD, LEED, BREEAM, GLOBAL RECYCLED STANDARD, PEFC (ST 2002:2013) y OEKO-TEX STANDARD 100.

## Absorption coefficient

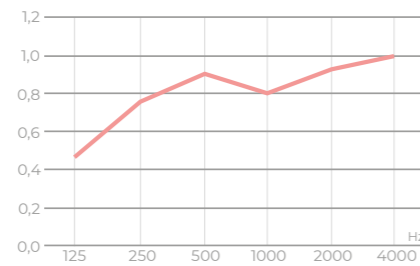

## Available thickness

— 18 mm

## Available Sizes

2340 mm x 1170 mm. Customized.

## Technical sheet

**Composition**  
Recycled textile fiber.

**Weight approx**  
4.5 Kg/ 8,0 Kg

**Absorption**  
No air chamber  
( $\alpha_w$  0.3)  
NCR= 0.45  
Air chamber 50 mm  
( $\alpha_w$  0.75)  
NCR= 0.8  
Air chamber 200 mm  
( $\alpha_w$  0.9)  
NCR= 0.85

**Cutting tolerance**  
 $\pm 2$  mm

**Fire resistance**  
B-s1-d0. Flame retardant.  
for public place.

## ECOWall | Volume

### New

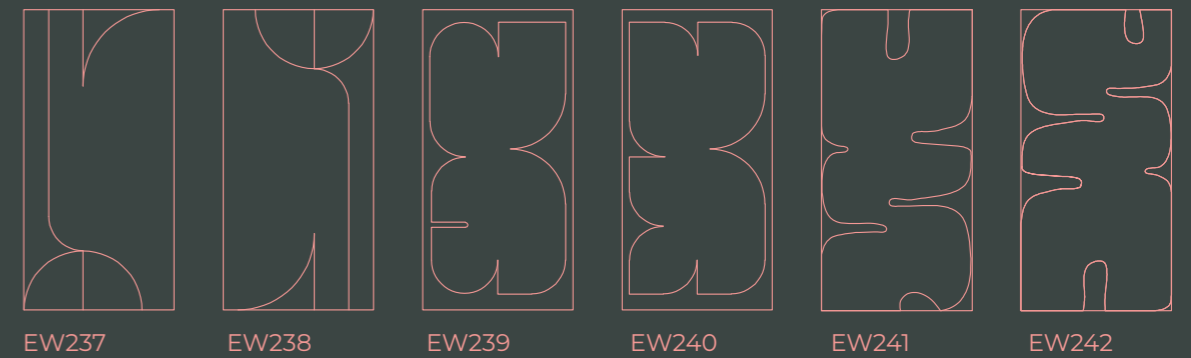
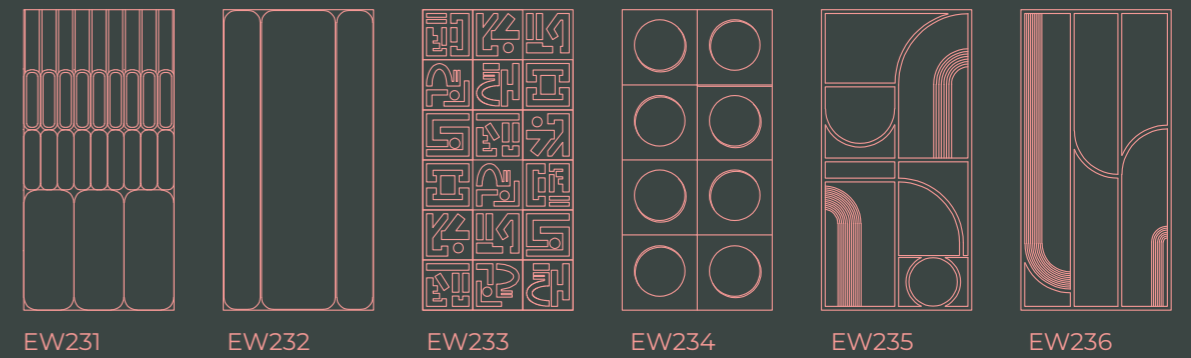

### Classic

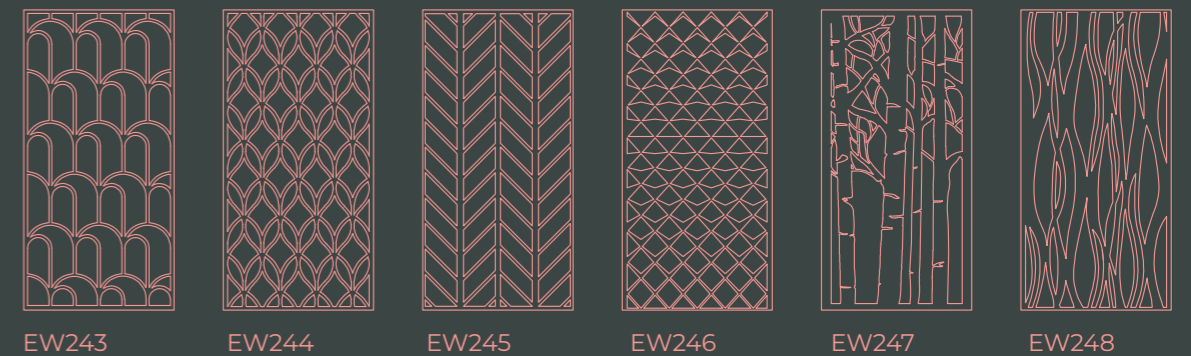

New

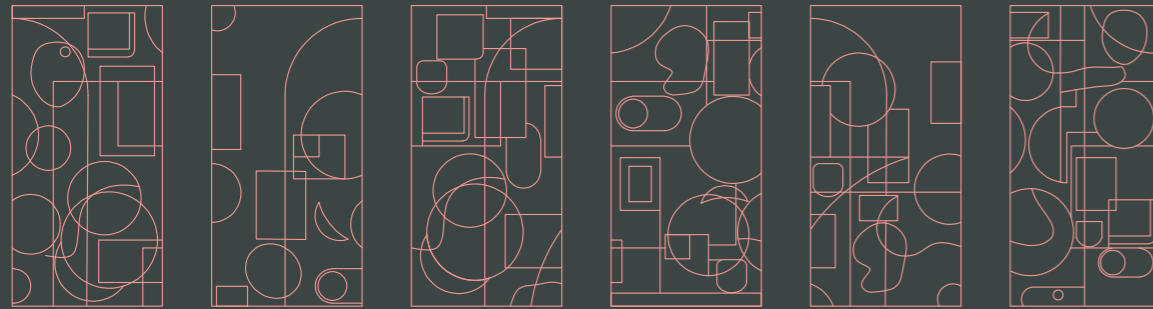

EW249

EW250

EW251

EW252

EW253

EW254

New



EW255

EW256

EW257

EW258

EW259

EW260

## Product description

The EMOTION print family is a recycled polyester fiber acoustic panel from the ECO range of ECOcero, model ECOWall emotion, printed family with bevel, available in catalog or customized designs, with dimensions of 2340x1170 mm and a thickness of 12 mm. It includes a system for fixation using contact adhesive from the ECOcero brand for direct attachment to support. Available in catalog image colors. It is CE marked and certified with GOLD, FSC STANDARD, LEED, BREEAM, GLOBAL RECYCLED STANDARD, PEFC (ST 2002:2013), and OEKO-TEX STANDARD 100.

Panel acústico de fibra de poliéster reciclada gama ECO de ECOcero, modelo ECOWall emotion, familia impresa con bisel, diseño de catálogo o personalizado, de medidas 2340x1170 mm, espesor 12 mm. Incluida p/p de sistema de fijación mediante cola de contacto de la marca ECOcero para fijación directa a soporte. Disponible en colores de imagen de catálogo. Marcado CE, con certificado GOLD, FSC STANDARD, LEED, BREEAM, GLOBAL RECYCLED STANDARD, PEFC (ST 2002:2013) y OEKO-TEX STANDARD 100.

## Absorption coefficient

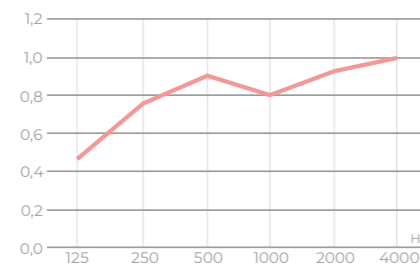

## Available thickness

12 mm

## Available Sizes

2340 mm x 1170 mm. Customized.

## Technical sheet

**Composition**  
Recycled textile fiber.

**Weight approx**  
6,50 Kg

**Absorption**  
No air chamber (αw 0.3)  
NCR= 0.45  
Air chamber 50 mm (αw 0.75)  
NCR= 0.8  
Air chamber 200 mm: (αw 0.9)  
NRC= 0.85

**Cutting tolerance**  
± 2 mm

**Fire resistance**  
B-s1-d0. Flame retardant. for public place.

## Product description

The EMOTION shapes family is a recycled polyester fiber acoustic panel from the ECO range of ECOcero, model ECOWall emotion, shapes family, available in catalog design, with dimensions of 1750x585 mm and a thickness of 9mm or 12 mm. It includes a system for fixation using contact adhesive from the ECOcero brand for direct attachment to support. There is also the possibility of vertical suspension from the horizontal surface using the ECOcero brand's C Anchor fixation system. Available in 16 base colors. It is CE marked and certified with GOLD, FSC STANDARD, LEED, BREEAM, GLOBAL RECYCLED STANDARD, PEFC (ST 2002:2013), and OEKO-TEX STANDARD 100.

Panel acústico de fibra de poliéster reciclada gama ECO de ECOcero, modelo ECOWall emotion, familia forma, diseño de catálogo, de medidas 1750x585 mm, espesor 9mm o 12 mm. Incluida p/p de sistema de fijación mediante cola de contacto de la marca ECOcero para fijación directa a soporte. Posibilidad de suspender verticalmente del paramento horizontal mediante sistema de fijación de la marca ECOcero, modelo de Anclaje C. Disponible en 16 colores base. Marcado CE, con certificado GOLD, FSC STANDARD, LEED, BREEAM, GLOBAL RECYCLED STANDARD, PEFC (ST 2002:2013) y OEKO-TEX STANDARD 100.

## Absorption coefficient

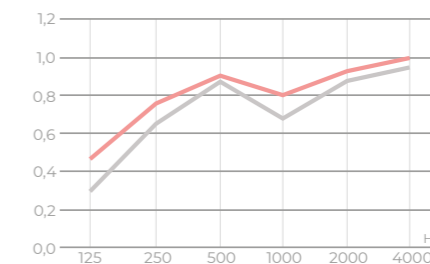

## Available thickness

12 mm  
9 mm

## Available Sizes

1750 mm x 585 mm

## Technical sheet

**Composition**  
Recycled textile fiber.

**Weight approx**  
3,0 kg/5,0 kg for pack 2 U.

**Absorption**  
9 mm  
No air chamber (αw 0.25)  
NRC=0.3  
Air chamber 200 mm (αw 0.8)  
NRC= 0.80  
12 mm  
No air chamber (αw 0.3)  
NRC=0.45  
Air chamber 50 mm (αw 0.75)  
NRC=0.8  
Air chamber 200 mm (αw 0.9)  
NRC= 0.85

**Cutting tolerance**  
± 2 mm

**Fire resistance**  
B-s1-d0. Flame retardant. for public place.



New

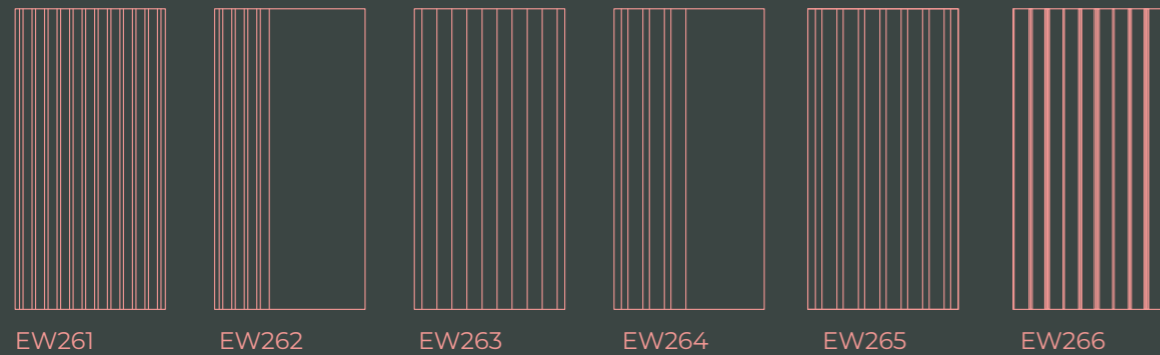

Classic

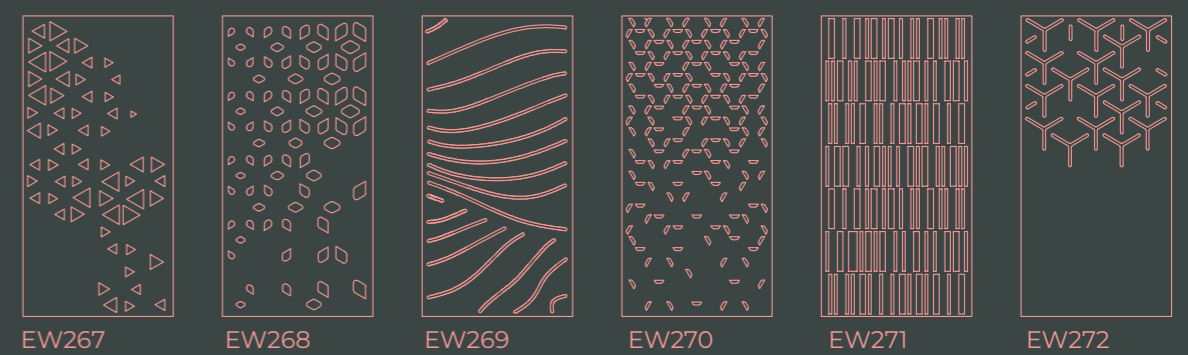

Product description

The EMOTION moldings family is a recycled polyester fiber acoustic panel from the ECO range of ECOcero, model ECOWall emotion, moldings family, available in catalog design, with dimensions of 2340x1170 mm and thicknesses of 37 mm or 62 mm. It includes a system for fixation using contact adhesive from the ECOcero brand for direct attachment to support, with the possibility of mechanical fixation to support. Available in 16 base colors. It is CE marked and certified with GOLD, FSC STANDARD, LEED, BREEAM, GLOBAL RECYCLED STANDARD, PEFC (ST 2002:2013), and OEKO-TEX STANDARD 100.

Panel acústico de fibra de poliéster reciclada gama ECO de ECOcero, modelo ECOWall emotion, familia molduras, diseño de catálogo, de medidas 2340x1170 mm, espesor 37 mm o 62 mm. Incluida p/p de sistema de fijación mediante cola de contacto de la marca ECOcero para fijación directa a soporte. Posibilidad de fijación mecánica a soporte. Disponible en 16 colores base. Marcado CE, con certificado GOLD, FSC STANDARD, LEED, BREEAM, GLOBAL RECYCLED STANDARD, PEFC (ST 2002:2013) y OEKO-TEX STANDARD 100.

Absorption coefficient

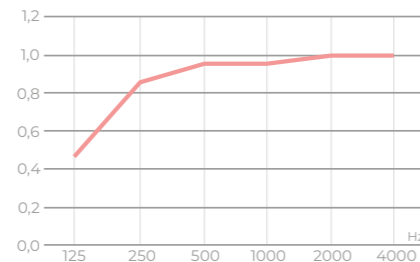

Available thickness

37mm / 62 mm

Available Sizes

2340 mm x 1170 mm

Model	Available configurations
EW261-262	C/D
EW263	A/B
EW264-265	A/B
EW266	E

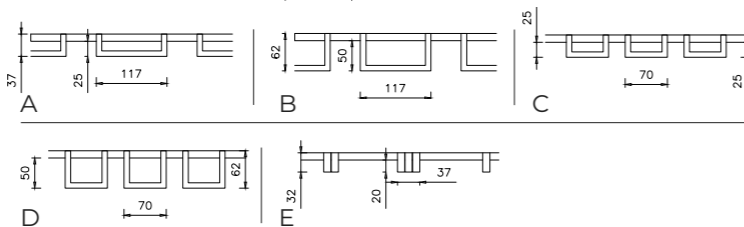

Technical sheet

**Composition**  
Recycled textile fiber.

**Weight approx**  
8,0 / 14,5 kg

**Absorption**  
No air chamber (αw 0.5)  
NRC=0.7  
Air chamber 200 mm (αw 1.0)  
NRC= 0.95

**Cutting tolerance**  
± 2 mm

**Fire resistance**  
B-s1-d0. Flame retardant.  
CTE for public place.

Product description

The EMOTION classics family is a recycled polyester fiber acoustic panel from the ECO range of ECOcero, model ECOWall emotion, classic family, available in catalog or customized designs, with dimensions of 2340x1170 mm and thicknesses of 9mm or 12 mm. It offers the option of installation as a suspended divider using a 2.0 m long cable with a carabiner and a fixation to anchor to the ceiling. It includes a system for fixation using contact adhesive from the ECOcero brand for direct attachment to support. Available in 16 base colors. It is CE marked and certified with GOLD, FSC STANDARD, LEED, BREEAM, GLOBAL RECYCLED STANDARD, PEFC (ST 2002:2013), and OEKO-TEX STANDARD 100.

Panel acústico de fibra de poliéster reciclada gama ECO de ECOcero, modelo ECOWall emotion, familia classic, diseño de catálogo o personalizado, de medidas 2340x1170 mm, espesor 9mm o 12 mm. Opción de instalación como divisorio suspendido mediante cable de 2,0 m de longitud mediante cable de 2,0 m de longitud para anclar al techo. Incluida p/p de sistema de fijación mediante cola de contacto de la marca ECOcero para fijación directa a soporte. Disponible en 16 colores base. Marcado CE, con certificado GOLD, FSC STANDARD, LEED, BREEAM, GLOBAL RECYCLED STANDARD, PEFC (ST 2002:2013) y OEKO-TEX STANDARD 100.

Absorption coefficient

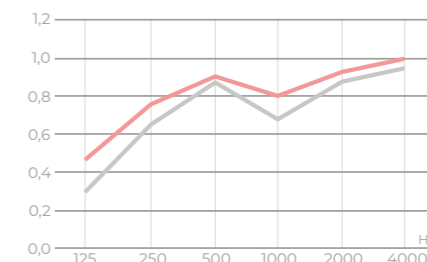

Available thickness

12 mm  
9 mm

Available Sizes

2340 mm x 1170 mm. Customized

Technical sheet

**Composition**  
Recycled textile fiber.

**Weight approx**  
3 kg/ 5,5 Kg

**Absorption**  
9 mm  
No air chamber (αw 0.25)  
NRC=0.3  
Air chamber 200 mm (αw 0.8)  
NRC= 0.80  
12 mm  
No air chamber (αw 0.3)  
NRC=0.45  
Air chamber 50 mm (αw 0.75)  
NRC=0.8  
Air chamber 200 mm (αw 0.9)  
NRC= 0.85

**Cutting tolerance**  
± 2 mm

**Fire resistance**  
B-s1-d0. Flame retardant.  
CTE for public place.

# Meet by Erico Navazo

ECOnordik



## Product description

The Meet model by Erico Navazo is an acoustic panel with dimensions of 2340 x 585 mm and a thickness of 19 mm, non-fireproof, composed of a base panel of 9 mm thickness made from recycled polyester fiber from the ECO range of ECOcero and MDF strips with a melamine finish of 27x10 mm section and a spacing of 12 mm between them. It includes a system for fixation using contact adhesive from the ECOcero brand for direct attachment to a vertical support with backing. For horizontal installation without support, mechanical fixation using screws is necessary. Available in 3 melamine colors (oak, nature oak, and ash) and 16 base colors for the 9 mm thick ECO range panel. It is CE marked and certified with GOLD, FSC STANDARD, LEED, BREEAM, GLOBAL RECYCLED STANDARD, PEFC (ST 2002:2013), and OEKO-TEX STANDARD 100.

Panel acústico modelo Meet de Erico Navazo, de dimensiones 2340 x 585 mm y espesor 19 mm, no ignífugo, compuesto por un panel base de 9 mm de espesor de fibra de poliéster reciclada gama ECO de ECOcero y listones MDF con acabado en melamina de 27x10 mm de sección y separación entre ellos de 12 mm. Incluida p/p de sistema de fijación mediante cola de contacto de la marca ECOcero para fijación directa a soporte vertical con apoyo. Para instalación horizontal y sin apoyo será necesario instalación con fijación mecánica mediante tornillería. Disponible en 3 colores de melamina (roble, roble nature y fresno) y 16 colores base para el panel de la Gama ECO de 9 mm de espesor. Marcado CE, VOC con certificación GOLD, FSC STANDARD, LEED, BREEAM, GLOBAL RECYCLED STANDARD, PEFC (ST 2002:2013) y OEKO-TEX STANDARD 100.

## Technical sheet

**Composition**  
Wood fiberboard (MDF)  
+ Recycled textile fiber

**Weight approx:**  
9 Kg

**Absorption**  
ECO line panel  
9 mm  
No air chamber  
( $\alpha_w$  0.25)  
NRC: 0.3  
Air chamber 200 mm  
( $\alpha_w$  0.8)  
NRC: 0.8

**Cutting tolerance**  
 $\pm 2$  mm

**Fire resistance**  
ECO line panel:  
Euroclass B-s1, d0 and compliant  
with low VOC emissions.  
MDF: Euroclass D-s2, d0 fire  
reaction rating

## Absorption coefficient

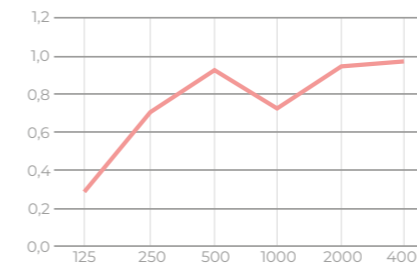

## Available thickness

— 19 mm

## Available Sizes

2340 mm x 585 mm

## Econordik | Meet

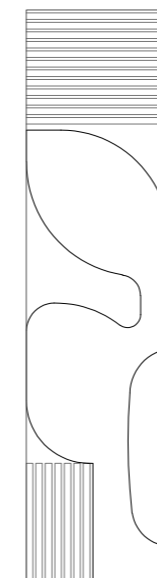

Model A



Model B

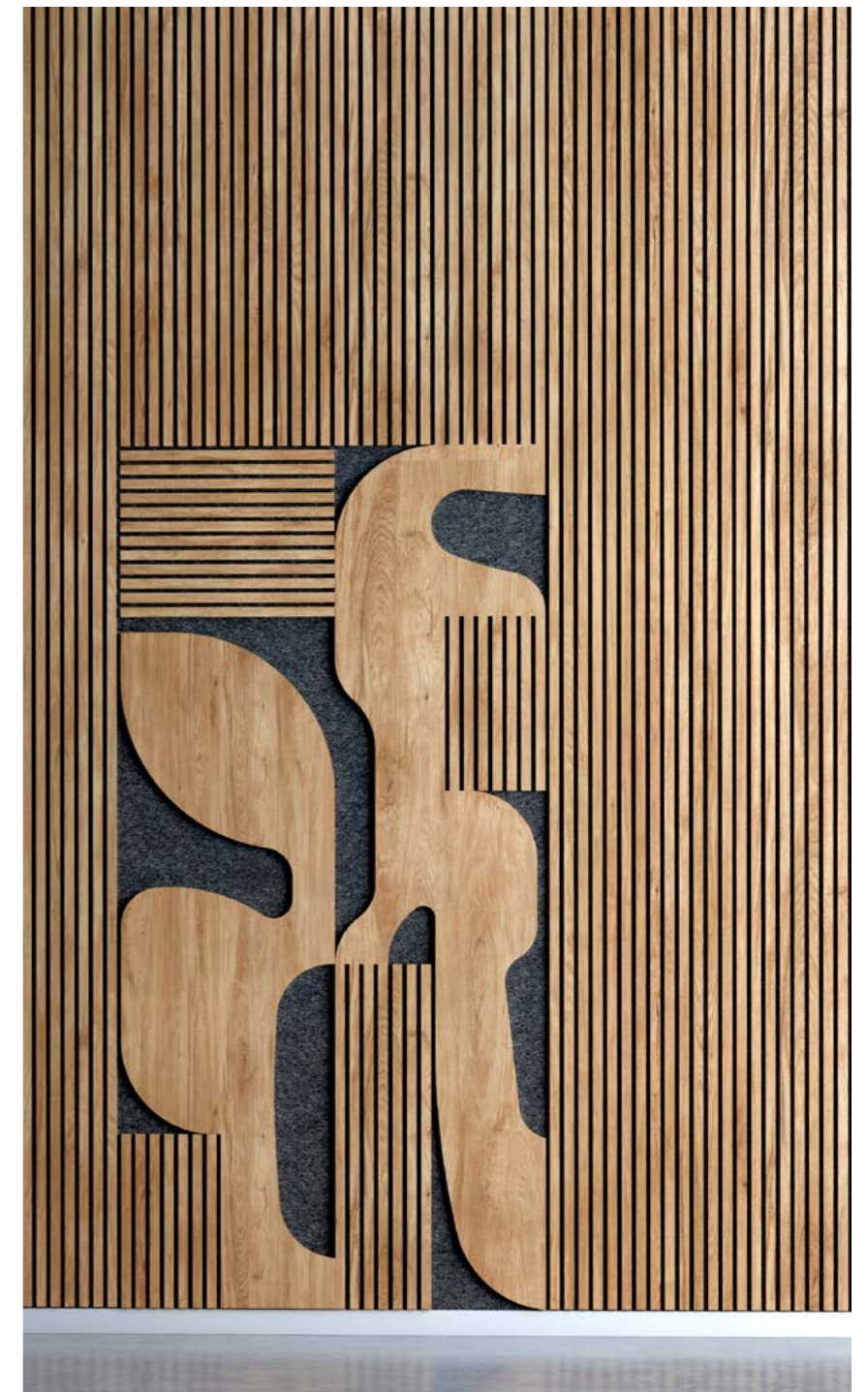

# Classic | Curve | Colour

ECOnordik



## Product description

### ECOnordik Fireproof:

The ECOnordik model is a fireproof acoustic panel with dimensions of 2340x585 mm and a thickness of 21 mm, consisting of a 9 mm thick base panel made from recycled polyester fiber from the ECO range of ECOcero, and MDF slats with a melamine finish of 27x12 mm section and a spacing of 12 mm between them. It includes a fixation system using contact adhesive from ECOcero for direct attachment to vertical supports with backing. For horizontal installation without support, mechanical fixation using screws is necessary. Available in three melamine colors (oak, nature oak, and ash) and 16 base colors for the 9 mm thick ECO range panel. It is CE marked, VOC certified with GOLD, FSC STANDARD, LEED, BREEAM, GLOBAL RECYCLED STANDARD, PEFC (ST 2002:2013), and OEKO-TEX STANDARD 100.

### ECOnordik ignífugo:

Panel acústico modelo ECOnordik, de dimensiones 2340x585 mm y espesor 21 mm, ignífugo, compuesto por un panel base de 9 mm de espesor de fibra de poliéster reciclada gama ECO de ECOcero y listones MDF con acabado en melamina de 27x12 mm de sección y separación entre ellos de 12 mm. Incluida p/p de sistema de fijación mediante cola de con-

tacto de la marca ECOcero para fijación directa a soporte vertical con apoyo. Para instalación horizontal y sin apoyo será necesario instalación con fijación mecánica mediante tornillería. Disponible en 3 colores de melamina (roble, roble nature y fresno) y 16 colores base para el panel de la Gama ECO de 9 mm de espesor. Marcado CE, VOC con certificación GOLD, FSC STANDARD, LEED, BREEAM, GLOBAL RECYCLED STANDARD, PEFC (ST 2002:2013) y OEKO-TEX STANDARD 100.

### ECOnordik Non Fireproof:

The ECOnordik model is a non-fireproof acoustic panel with dimensions of 2340x585 mm and a thickness of 19 mm, composed of a base panel of 9 mm thickness made from recycled polyester fiber from the ECO range of ECOcero and MDF strips with a melamine finish of 27x10 mm section and a spacing of 12 mm between them. It includes a system for fixation using contact adhesive from the ECOcero brand for direct attachment to a vertical support with backing. For horizontal installation without support, mechanical fixation using screws is necessary. Available in 3 melamine colors (oak, nature oak, and ash) and 16 base colors for the 9 mm thick ECO range panel. Lacquering in RAL or NCS colors

is available. It is CE marked and certified with GOLD, FSC STANDARD, LEED, BREEAM, GLOBAL RECYCLED STANDARD, PEFC (ST 2002:2013), and OEKO-TEX STANDARD 100.

### ECOnordik No ignífugo:

Panel acústico modelo ECOnordik, de dimensiones 2340x585 mm y espesor 19 mm, no ignífugo, compuesto por un panel base de 9 mm de espesor de fibra de poliéster reciclada gama ECO de ECOcero y listones MDF con acabado en melamina de 27x10 mm de sección y separación entre ellos de 12 mm. Incluida p/p de sistema de fijación mediante cola de contacto de la marca ECOcero para fijación directa a soporte vertical con apoyo. Para instalación horizontal y sin apoyo será necesario instalación con fijación mecánica mediante tornillería. Disponible en 3 colores de melamina (roble, roble nature y fresno) y 16 colores base para el panel de la Gama ECO de 9 mm de espesor. Disponible lacado en colores RAL o NCS. Marcado CE, VOC con certificación GOLD, FSC STANDARD, LEED, BREEAM, GLOBAL RECYCLED STANDARD, PEFC (ST 2002:2013) y OEKO-TEX STANDARD 100.

## Colours

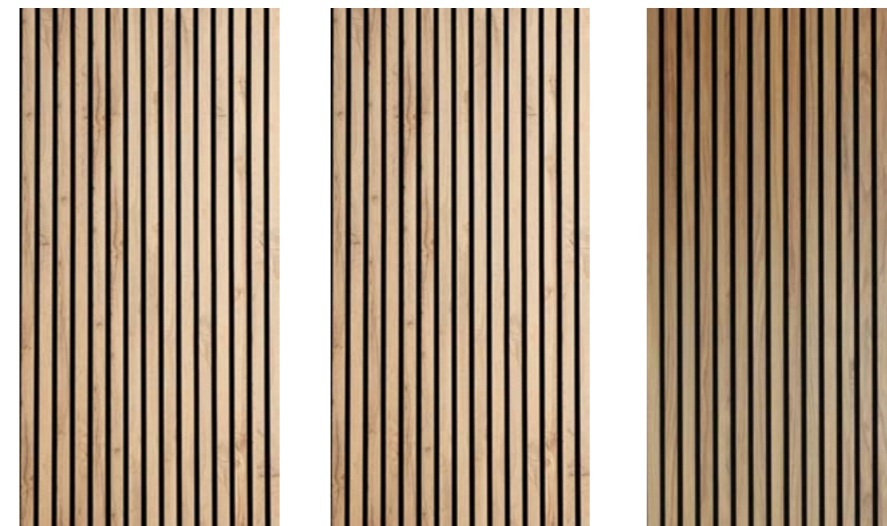

Oak

Oak nature

Ash

## Absorption coefficient

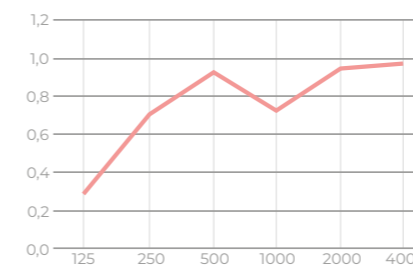

## Available thickness

- 19 mm Regular MDF
- 21 mm Non fireproof MDF

## Available Sizes

2340 mm x 585 mm

## ECOnordik

	Classic	Curve	Colour
Fireproof	x	x	
Non fireproof	x	x	x

## Technical sheet

### Composition

Wood fibreboard (MDF)  
+ Recycled textile fiber

### Weight approx

9 Kg

### Absorption

ECO line panel  
9 mm  
No air chamber  
(aw 0.25)  
NRC: 0.3  
Air chamber 200 mm  
(aw 0.8)  
NRC: 0.8

### Cutting tolerance

± 2 mm

### Fire resistance

ECO line panel  
Euroclass B-s1, d0 and compliant with low VOC emissions.  
Non fireproof MDF  
Euroclass D-s2, d0 fire reaction rating  
Fireproof MDF  
Euroclass B-s2, d0

# Seaqual

EONordik



## Product description

The SEAQUAL EW278 model is an acoustic panel from the EONordik line, measuring 2340x585 mm with a 20 mm thickness, non-fireproof, made from 80% recycled polyester fibers sourced from the ocean floor as part of the SEAQUAL initiative for high thermal and acoustic performance, and MDF slats with a melamine finish of 27 x 10 mm section and a spacing of 12 mm between them. It includes a fixation system using contact adhesive from ECOcero for direct attachment to vertical supports with backing. For horizontal installation without support, mechanical fixation using screws is necessary. Available in three melamine colors (oak, nature oak, and ash) and black for the 10 mm thick SEAQUAL panel.

Panel acústico modelo EONordik, de dimensiones 2340x585 mm y espesor 20 mm, no ignífugo, compuesto panel acústico fabricado con un 80% de fibras de poliéster recicladas procedentes del fondo marino como parte de la iniciativa SEAQUAL con altas prestaciones térmicas y acústicas y listones MDF con acabado en melamina de 27 x 10 mm de sección y separación entre ellos de 12 mm. Incluida p/p de sistema de fijación mediante cola de contacto de la marca ECOcero para fijación directa a soporte vertical con apoyo. Para instalación horizontal y sin apoyo será necesario instalación con fijación mecánica mediante tornillería. Disponible en 3 colores de melamina (roble, roble nature y fresno) y color negro para panel Seaqual de 10 mm de espesor.

## Absorption coefficient

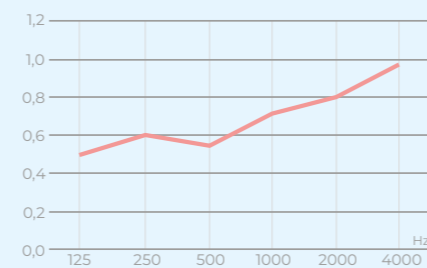

## Available thickness

— 20 mm Regular MDF

## Available Sizes

2340 x 585 mm

## Technical sheet

**Composition**  
Recycled textile fiber  
SEAQUAL initiative

**Weight approx**  
9 Kg

**Absorption**  
Air chamber 400 mm  
( $\alpha_w$  0.7)  
NRC: 0.65

**Thermal conductivity**  
0,032 W/m\*k

**Thermal resistance**  
0,526 m<sup>2</sup>\*k/W

**Cutting tolerance**  
± 2 mm

**Fire resistance**  
Non fireproof MDF: D-s2-d0

Thank you por supporting

SEAQUAL  
INITIATIVE

# Flap

by Rafa Ortega

ECOceiling



## Product description

The FLAP model is a suspended acoustic technical ceiling from ECOcero, featuring rotatable acoustic slats made from two 9mm recycled polyester fiber panels. Each module of 2200x1175 mm consists of 10 rotating slats of 1157x200x18 mm, with color choice available for each side of the slat. It includes a profiling system with U profiles of 2200 mm, M6 suspender, hangers, and caps. It is CE marked, VOC certified with GOLD, FSC STANDARD, LEED, BREEAM, GLOBAL RECYCLED STANDARD, PEFC (ST 2002:2013), and OEKO-TEX STANDARD 100.

Techo técnico acústico suspendido, modelo FLAP de la marca ECOcero, formado por lamas acústicas giratorias orientables compuestas por 2 paneles de fibra de poliéster reciclada de 9mm. Cada módulo de 2200x1175 mm se compone de 10 lamas giratorias de 1157x200x18 mm, color a escoger en cada cara de lama. Incluso p/p de sistema de perfilería con perfiles U 2200 mm, suspensor M6, colgadores y tapones. Marcado CE, VOC con certificación GOLD, FSC STANDARD, LEED, BREEAM, GLOBAL RECYCLED STANDARD, PEFC (ST 2002:2013) y OEKO-TEX STANDARD 100.

## Absorption coefficient

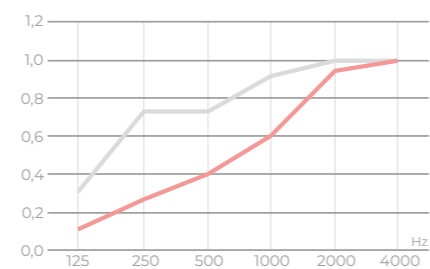

## Available positions

- Open slats
- Closed slats

## Ecoceiling | Flap

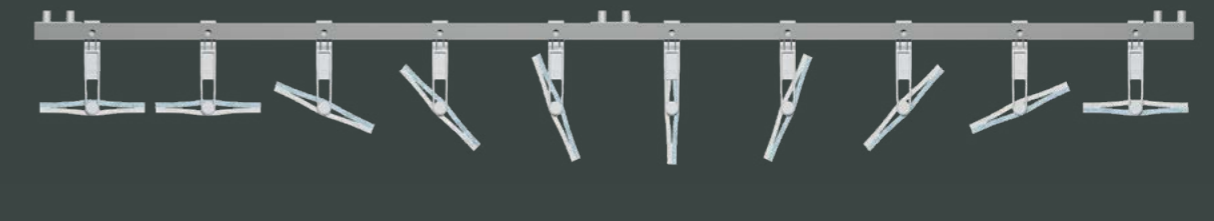
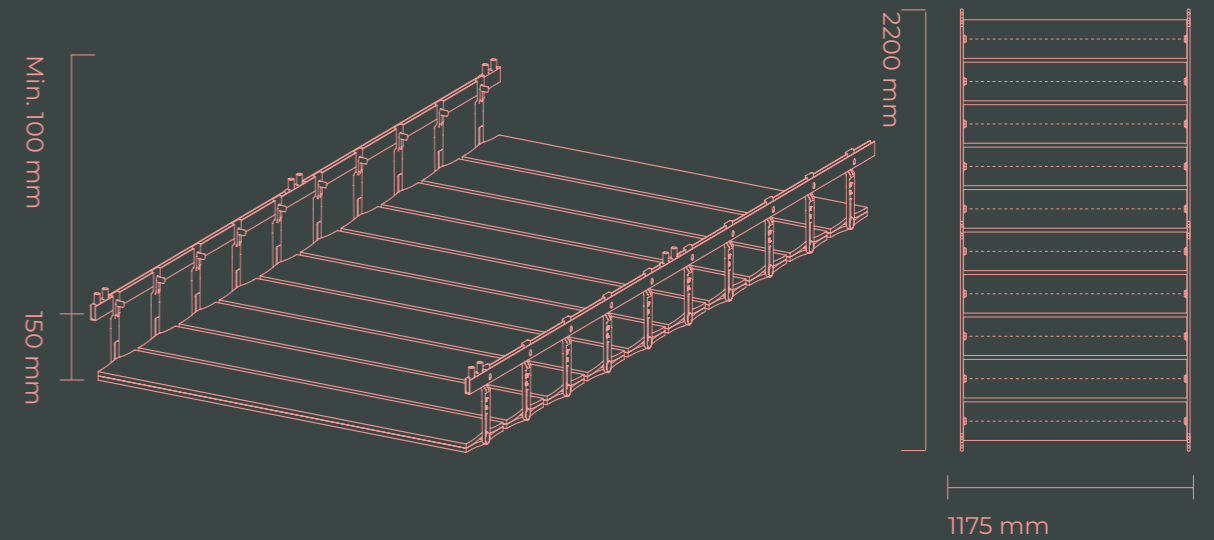

## Technical sheet

**Composition**  
Recycled textile fibre.

**Slat measure**  
1157x200 mm  
**Module Measure**  
2200 x 1175 mm

**Thickness**  
18 mm (9+9 mm)

**Modul Weight approx**  
8 Kg

**Absorption**  
Open slat (αw 0,45)  
NRC: 0.55  
Close slat (αw 0,8)  
NRC: 0.85

**Cutting tolerance**  
± 2 mm

**Fire resistance**  
B-s1-d0. Flame retardant.  
CTE for public place.

# Code

by Rafa Ortega

ECOceiling



## Product description

The CODE model is a continuous suspended technical ceiling composed of acoustic panels measuring 1200x600x9 mm with linear perforations, available in two models and a choice of 16 base colors. It includes decorative ribs and a bridge system for hanging to a T24 profile for registrable ceilings. Options for additional ribs, signage, and lighting boxes made of the same material (model Light Box) are available. It is CE marked, certified with GOLD, FSC STANDARD, LEED, BREEAM, GLOBAL RECYCLED STANDARD, PEFC (ST 2002:2013), and OEKO-TEX STANDARD 100.

Techo técnico continuo suspendido, compuesto por panel acústico modelo CODE de la marca ECOceiro, compuesto por paneles acústicos de fibra de poliéster reciclada de 1200x600x9 mm con perforaciones lineales, en dos modelos y color a escoger entre 16 colores base. Incluso p/p de costillas decorativas y sistema puente de cuelgue a perfil T24 para techo registrable. Opción de ampliación de costillas extras, señalética y cajetines para iluminación del mismo material modelo Light Box. Marcado CE, con certificación GOLD, FSC STANDARD, LEED, BREEAM, GLOBAL RECYCLED STANDARD, PEFC (ST 2002:2013) y OEKO-TEX STANDARD 100.

## Absorption coefficient

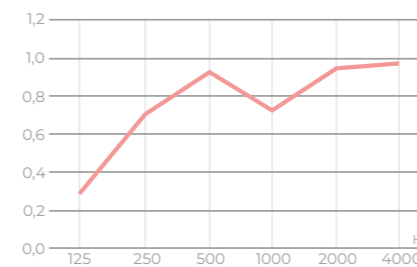

## Available thickness

— 9 mm

## Available Sizes

1200 x 600 mm

## ECOceiling | Code

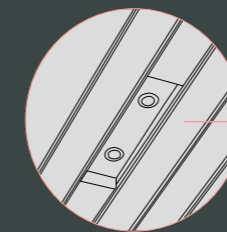

Light Box  
600 x 190 x 40 mm

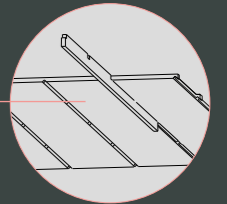
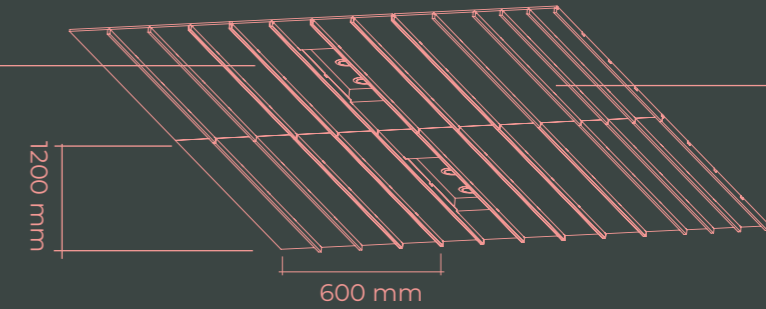

CODE Bands  
L 1200 mm

## Technical sheet

**Composition**  
Recycled textile fiber.

**Weight approx**  
2,50 Kg

**Absorption**  
Air chamber 200 mm  
( $\alpha_w$  0.8)  
NRC: 0.8  
No air chamber  
( $\alpha_w$  0.25)  
NRC: 0.3

**Cutting tolerance**  
 $\pm 2$  mm

**Fire resistance**  
B-s1-d0. Flame retardant.  
for public place.

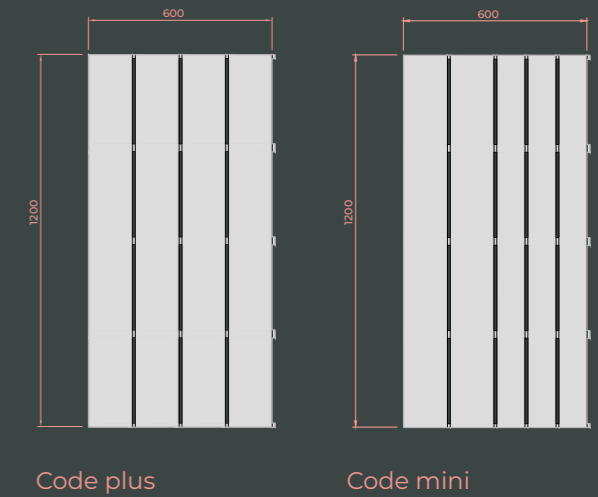

Code plus

Code mini

# Circular

by Rafa Ortega

ECOceiling



## Product description

A continuous suspended technical ceiling composed of the CIRCULAR model acoustic panel from ECOceero, featuring two recycled polyester fiber acoustic panels of 1186x1186x12 mm with a circular beveled pattern. Available in 16 base colors. Includes a hanging bridge system to a T24 profile for a registrable ceiling. It also offers the option of supplying suspended diffusers with diameters of 900 mm and 590 mm, made from the ECO range panel curved into a cylindrical crown shape. It is CE marked and certified with GOLD, FSC STANDARD, LEED, BREEAM, GLOBAL RECYCLED STANDARD, PEFC (ST 2002:2013), and OEKO-TEX STANDARD 100.

Techo técnico continuo suspendido, compuesto por panel acústico, modelo CIRCULAR de la marca ECOceero, compuesto por 2 paneles acústicos de fibra de poliéster reciclada de 1186x1186x12 mm con patrón biselado circular. Disponible en 16 colores base. Incluso p/p de sistema puente de cuelgue a perfil T24 para techo registrable. Opción de suministro de tulipas suspendidas de diámetro 900 mm y 590 mm, formadas por panel de la gama ECO curvado en forma de corona cilíndrica. Marcado CE con certificación GOLD, FSC STANDARD, LEED, BREEAM, GLOBAL RECYCLED STANDARD, PEFC (ST 2002:2013) y OEKO-TEX STANDARD 100.

## Absorption coefficient

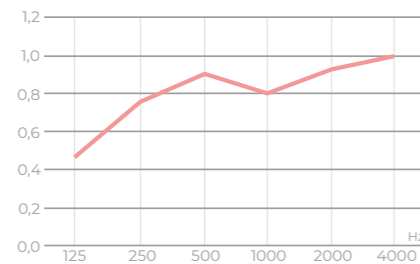

## Available thickness

12 mm

## Available Sizes

1180 x 1180 mm

## Technical sheet

### Composition

Recycled textile fiber.

**Modul weight approx 3,5 kg**

**Lampshade weight D590 0,7 kg**

**Lampshade weight D900 2,0 Kg**

### Absorption

No air chamber

(alpha\_w 0.3)

NCR= 0.45

Air chamber 50 mm

(alpha\_w 0.75)

NCR= 0.08

Air chamber 200 mm

(alpha\_w 0.9)

NCR= 0.85

### Cutting tolerance

± 2 mm

### Fire resistance

B-s1-d0. Flame retardant. for public place.

## ECOceiling | Circular

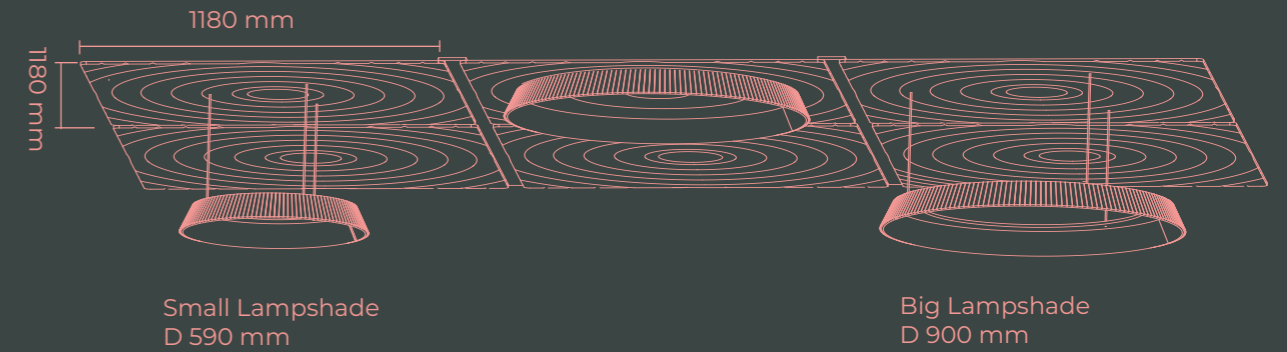

Small Lampshade  
D 590 mm

Big Lampshade  
D 900 mm

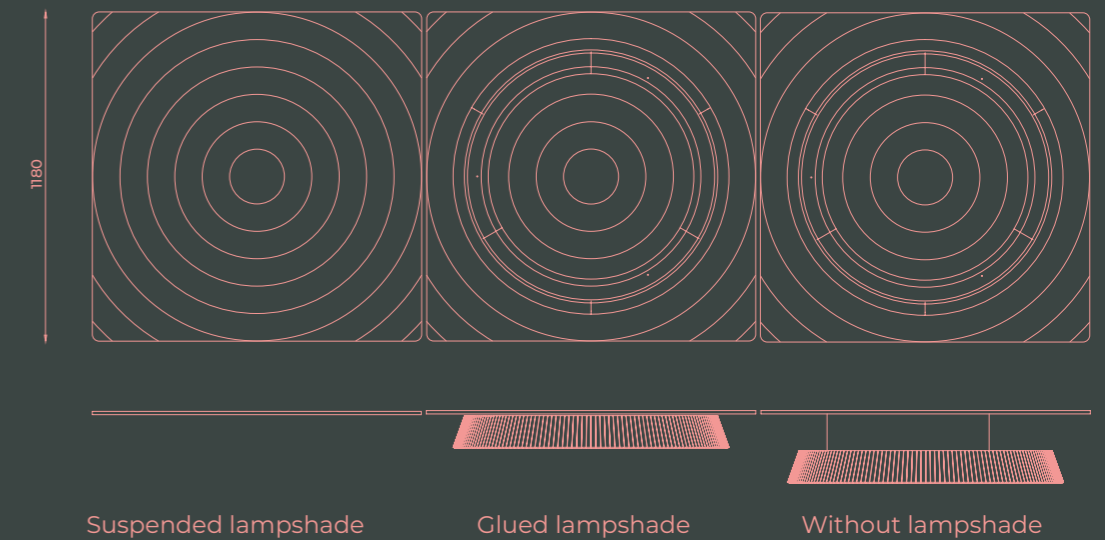

Suspended lampshade

Glued lampshade

Without lampshade

# Quadrilateral

ECOceiling

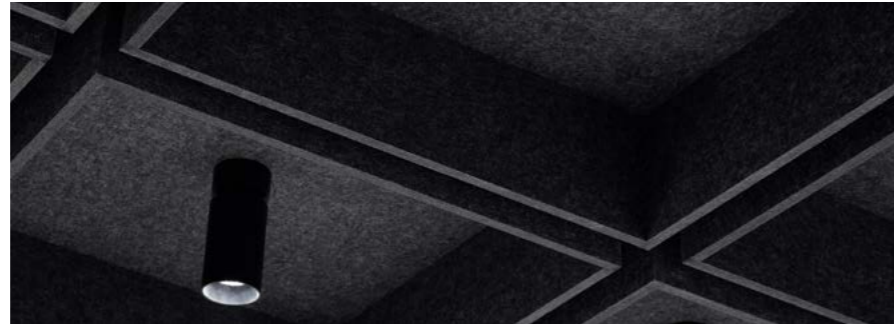

## Product description

A continuous ceiling from ECOcero, QUADRILATERAL model by Openbook, composed of a 9 mm thick recycled polyester fiber acoustic panel. Dimensions are 585x585x149 mm. Supplied unassembled for installation on-site. Includes a fixation system using contact adhesive from ECOcero for direct attachment to vertical support with backing. For horizontal installation without support, mechanical fixation with screws is necessary. Available in 16 base colors. It is CE marked and certified with GOLD, FSC STANDARD, LEED, BREEAM, GLOBAL RECYCLED STANDARD, PEFC (ST 2002:2013), and OEKO-TEX STANDARD 100.

Techo continuo de la marca ECOcero, modelo QUADRILATERAL by Openbook, compuesto por panel acústico de 9 mm de espesor de fibra de poliéster reciclada. Dimensiones 585x585x149 mm. Suministrado desmontado para instalación en obra. Incluida p/p de sistema de fijación mediante cola de contacto de la marca ECOcero para fijación directa a soporte vertical con apoyo. Para instalación horizontal y sin apoyo será necesario instalación con fijación mecánica mediante tornillería. Disponible en 16 colores base. Marcado CE, con certificado GOLD, FSC STANDARD, LEED, BREEAM, GLOBAL RECYCLED STANDARD, PEFC (ST 2002:2013) y OEKO-TEX STANDARD 100.

## Absorption coefficient

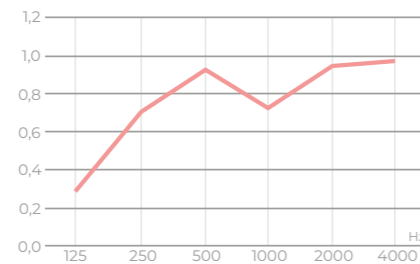

## Available thickness

9 mm

## Available Sizes

Volume 1 U. 585 x 585 x 149 mm

## Technical sheet

**Composition**  
Recycled textile fiber.

**Part Weight approx 1,1 Kg**  
**Weight approx 1 m<sup>2</sup> 3,5 kg**

**Absorption**  
No air chamber  
( $\alpha_w$  0.25)  
NRC: 0.3  
Air chamber 200 mm  
( $\alpha_w$  0.8)  
NRC: 0.80

**Cutting tolerance**  
 $\pm 2$  mm

**Fire resistance**  
B-s1-d0. Flame retardant.  
for public place.

## Assembly

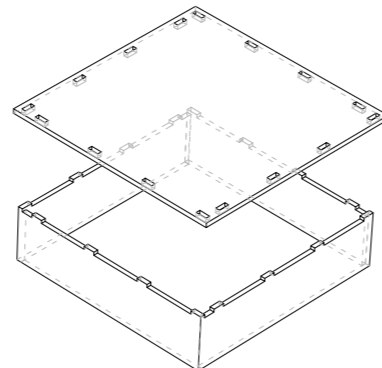

# Baffle

ECOceiling

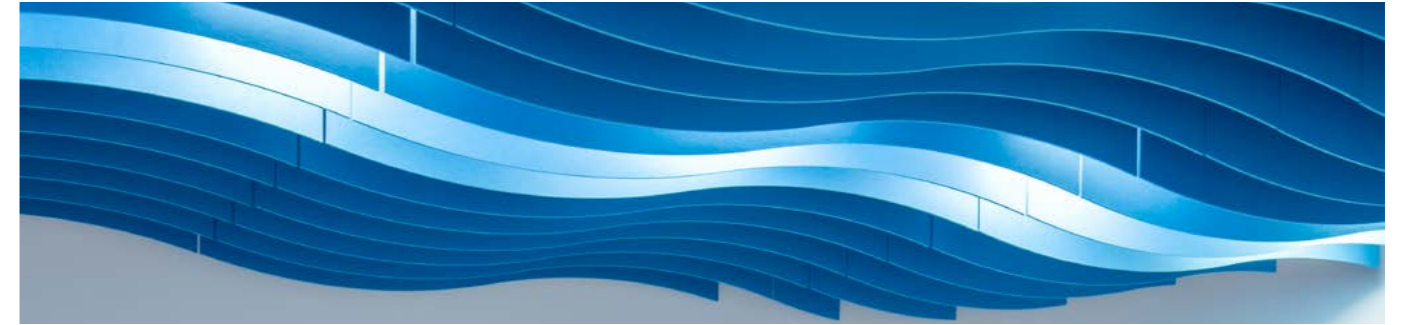

## Product description

An acoustic panel from the ECO range of ECOcero, ECObaffle model, with a catalog finish, dimensions of 2340x200 mm for the line model and 2340x390/194mm for the waves model, thickness of 12 mm. It is anchored vertically to the ceiling using the ECOcero brand's D Anchor system, consisting of a U-type clamp anchor with a pin through a perforation in the recycled polyester fiber panel for direct ceiling attachment. Available in 16 base colors. It is CE marked and certified with GOLD, FSC STANDARD, LEED, BREEAM, GLOBAL RECYCLED STANDARD, PEFC (ST 2002:2013), and OEKO-TEX STANDARD 100.

Panel acústico de fibra de poliéster reciclada gama ECO de ECOcero, modelo ECObaffle, acabado de catálogo, de dimensiones de 2340 x 200 mm para el modelo line y 2340x390/194mm para el modelo waves, espesor de 12 mm, anclado a techo verticalmente mediante el sistema de fijación de la marca ECOcero, modelo Anclaje D, formado por un anclaje tipo U abrazadera con pasador a través de perforación a panel de fibra de poliéster reciclada para anclar directamente al techo. Disponible en 16 colores base. Marcado CE, con certificación GOLD, FSC STANDARD, LEED, BREEAM, GLOBAL RECYCLED STANDARD, PEFC (ST 2002:2013) y OEKO-TEX STANDARD 100.

## Absorption coefficient

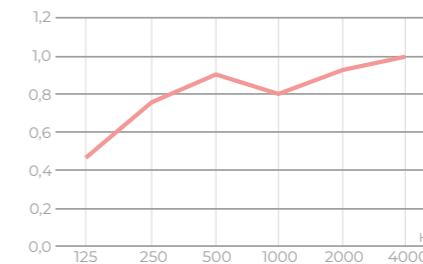

## Available thickness

12mm

## Available Sizes

Waves baffle 2340 x 390/194 mm  
Line baffle 2340 x 200 mm

## Technical sheet

**Composition**  
Recycled textile fiber.

**Weight approx 1,12 kg**

**Absorption**  
No air chamber  
( $\alpha_w$  0.3)  
NCR= 0.45  
Air chamber 50 mm  
( $\alpha_w$  0.75)  
NCR= 0.8  
Air chamber 200 mm  
( $\alpha_w$  0.9)  
NCR= 0.85

**Cutting tolerance**  
 $\pm 2$  mm

**Fire resistance**  
B-s1-d0. Flame retardant.  
for public place.



# Cloud

ECOceiling

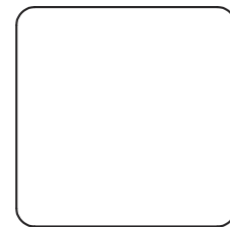

EW282

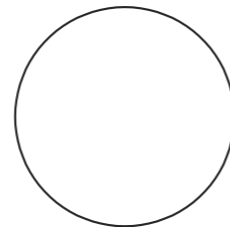

EW283

## Product description

An acoustic panel from the ECO range of ECOcero, ECO CLOUD model, with a catalog or customized finish, of various dimensions, thickness of 12 mm, suspended horizontally from the ceiling by the steel cable suspension system of ECOcero, B Anchor model, consisting of a screw-in female anchor for the recycled polyester fiber panel and a cable up to 2.00 m in length with a carabiner and a fixture for ceiling attachment. Available in 16 base colors. It is CE marked and certified with GOLD, FSC STANDARD, LEED, BREEAM, GLOBAL RECYCLED STANDARD, PEFC (ST 2002:2013), and OEKO-TEX STANDARD 100.

Panel acústico de fibra de poliéster reciclada gama ECO de ECOcero, modelo ECOcloud, acabado de catálogo o personalizado, de medidas varias, espesor de 12 mm, suspendido horizontalmente del techo mediante el sistema de suspensión por cable de acero de la marca ECOcero, modelo Anclaje B, formado por un anclaje tipo hembra para atornillar al panel de fibra de poliéster reciclada y un cable de hasta 2,00 m de longitud con un mosquetón y una fijación para anclar a techo. Disponible en 16 colores base. Marcado CE, con certificación GOLD, FSC STANDARD, LEED, BREEAM, GLOBAL RECYCLED STANDARD, PEFC (ST 2002:2013) y OEKO-TEX STANDARD 100.

## Absorption coefficient

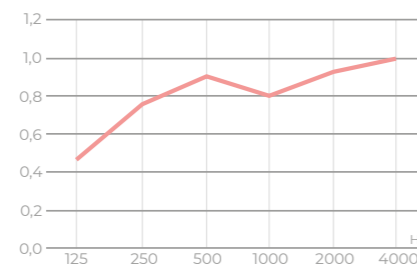

## Available thickness

— 12 mm

## Available Sizes

**EW282**  
780 x 780 mm  
1000 x 1000 mm  
1170x1170 mm  
585x1170 mm  
1170x2340 mm

**EW283**  
D 800mm  
D 1000 mm  
D 1170 mm

## Technical sheet

**Composition**  
Recycled textile fiber.

**Weight approx:**  
to consult depending on model and dimensions.

**Absorption**  
No air chamber (aw 0.3)  
NRC: 0.45  
Air chamber 50 mm (aw 0.75)  
NRC: 0.8  
Air chamber 200 mm (aw 0.9)  
NRC: 0.85

**Cutting tolerance**  
± 2 mm

**Fire resistance**  
B-s1-d0. Flame retardant. for public place.

# Aline

ECOceiling

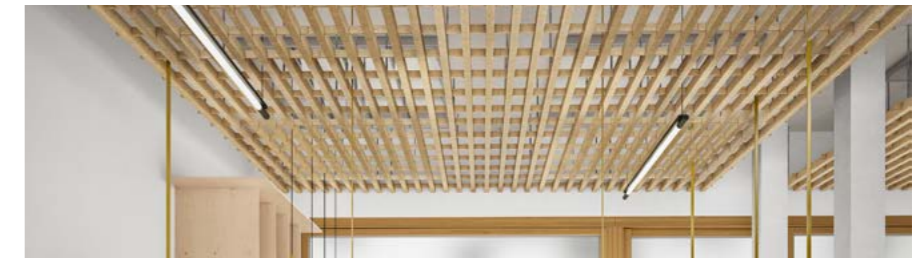

## Product description

A suspended acoustic ceiling, ALINE model from ECOcero, consists of U-shaped recycled polyester fiber acoustic panels of various sizes depending on the profile and 9mm thickness, spaced 50/100/150 mm apart and connected by straight tongue-and-groove ribs of 60mm width and 12mm thickness, manufactured in 2400\*1200 mm modules and available in a choice of our 16 base colors, including provision for anchors (6 anchors per module). It is CE marked and certified with GOLD, FSC STANDARD, LEED, BREEAM, GLOBAL RECYCLED STANDARD, PEFC (ST 2002:2013), and OEKO-TEX STANDARD 100.

Techo acústico suspendido, modelo ALINE de la marca ECOcero, compuesto por paneles acústicos de fibra de poliéster reciclada en forma de U de medidas varias dependiendo del perfil y espesor 9mm, separados 50/100/150 mm entre cada unidad y unidos por costillas machihembradas rectas de 60mm y 12mm de espesor, fabricado en módulos de 2400\*1200 mm y color a escoger entre nues-

tros 16 colores base, incluso p/p de anclajes (6 anclajes por módulo). Marcado CE, con certificación GOLD, FSC STANDARD, LEED, BREEAM, GLOBAL RECYCLED.

## Absorption coefficient

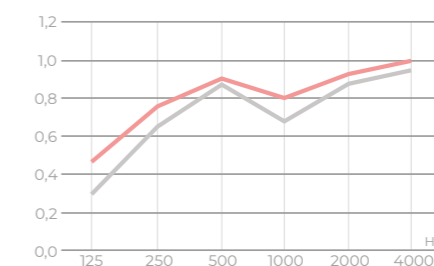

## Available thickness

— U-shapes thickness: 12 mm  
— Ribs thickness: 9 mm

## Available Sizes

2400 x 1200 mm

	Model	A	B	C	D	e1	e2
<b>U2021P0</b>	Aline U75/50U202P3	75	50	60	50	9	12
<b>U202P3</b>	Aline U75/50	75	50	60	100	9	12
<b>U201P2</b>	Aline U50/100	50	100	60	50	9	12
<b>U301P1</b>	Aline U125/50	125	50	60	150	9	12
<b>UM-301-201-202 P3</b>	Aline UM 125/50-75/50-50/100	125/75/50	50/50/100	60	150/variable/75	9	12
<b>UM-201-202- P3</b>	Aline UM 75/50-50/100	75/50	50/100	60	75	9	12

## Technical sheet

**Composition**  
Recycled textile fiber.

**Weight approx**  
to consult depending on model and dimensions.

**Absorption**  
9mm  
Air chamber 200 mm (aw 0.8)  
NRC= 0.80  
12mm  
Air chamber 200 mm (aw 0.9)  
NRC= 0.85

**Cutting tolerance**  
± 2 mm

**Fire resistance**  
B-s1-d0. Flame retardant. for public place.

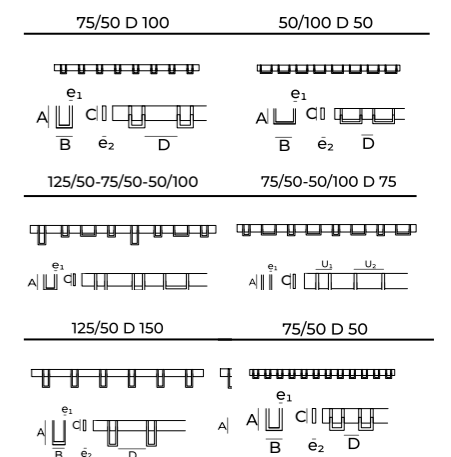

# Lumomesh by The Room Studio

ECOcollections



## Product description

An acoustic panel from the ECO range of ECOcero, LUMOMESH model by The Room Studio, dimensions 1120x560 mm and 560x560 mm, thickness 30 mm, consisting of two panels of 9 mm thickness and one panel of 12 mm thickness. Designed for easy installation of linear lighting, LUMOMESH merges acoustics, lighting, and design into a single product, offering solutions to create harmonious and exceptional environments. Its magic lies in the absence of predefined patterns and its combination between them. Includes a fixation system using contact adhesive from ECOcero for direct attachment to vertical support with backing. For horizontal installation without support, mechanical fixation with screws is necessary. Available in 16 base colors. It is CE marked and certified with GOLD, FSC STANDARD, LEED, BREEAM, GLOBAL RECYCLED STANDARD, PEFC (ST 2002:2013), and OEKO-TEX STANDARD 100.

Panel acústico de fibra de poliéster reciclada gama ECO de la marca ECOcero, modelo LUMOMESH de The Room studio, de medidas 1120x560 mm y 560x560 mm, de espesor 30 mm, formada por 2 paneles de 9 mm de espesor y un panel de 12 mm de espesor. Preparado para una fácil instalación de iluminación lineal. LUMOMESH logra fusionar la acústica, la iluminación y el diseño en un solo producto, aportando soluciones para crear ambientes armoniosos y excepcionales. La magia reside en la ausencia de patrones predefinidos y en su combinación entre ellos. Incluida p/p de sistema de fijación mediante cola de contacto de la marca ECOcero para fijación directa a soporte vertical con apoyo. Para instalación horizontal y sin apoyo será necesario instalación con fijación mecánica mediante tornillería. Disponible en 16 colores base. Marcado CE, con certificación GOLD, FSC STANDARD, LEED, BREEAM, GLOBAL RECYCLED STANDARD, PEFC (ST 2002:2013) y OEKO-TEX STANDARD 100.

## Technical sheet

**Composition**  
Recycled textile fiber.

**Weight approx**  
Model A: 3,4 kg  
Model B: 1,7 Kg

**Absorption**  
No air chamber  
( $\alpha_w$  0.5)  
NRC: 0.7  
Air chamber 200 mm  
( $\alpha_w$  1)  
NRC: 0.95

**Cutting tolerance**  
 $\pm 2$  mm

**Fire resistance**  
B-s1-d0. Flame retardant.  
for public place.

## ECOcollections | Lumomesh

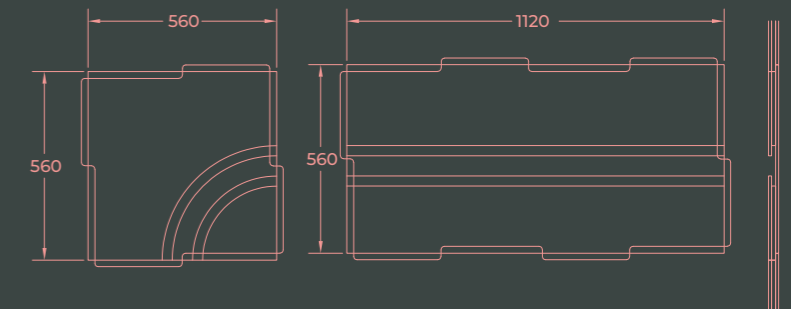
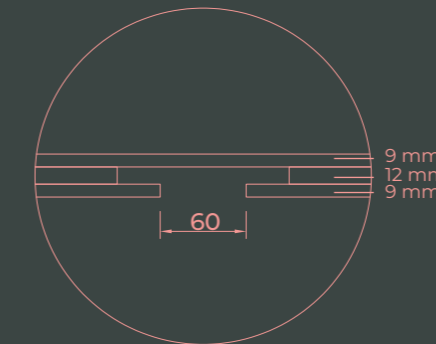

## Absorption coefficient

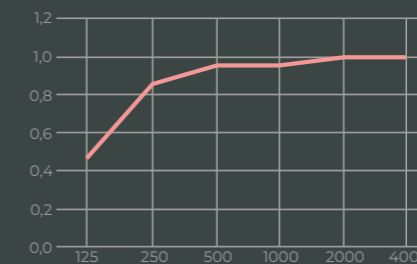

## Available thickness

30 mm (9+12+9)

## Module Sizes

Models A: 560 x 560 mm  
Models B: 1120 x 560 mm

## Available finishes

Plain  
Plain fosing  
Beveled

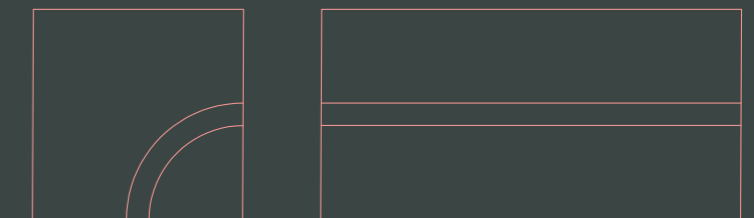

A1

B1

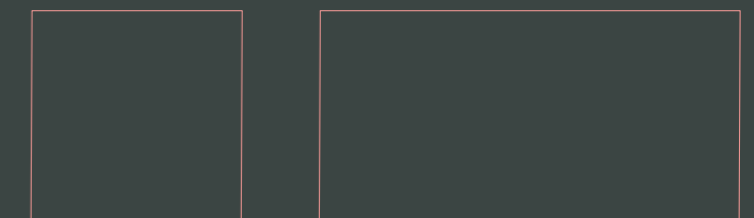

A2

B2

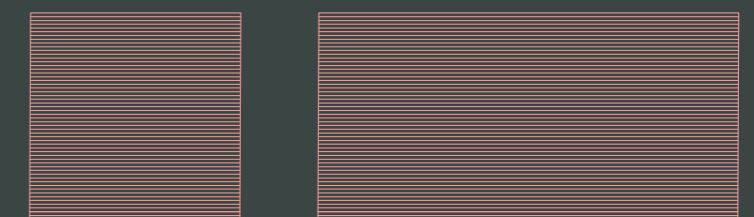

A3

B3

# Puzzle by Masquespacio

ECOcollections



## Product description

An acoustic panel from the ECO range of ECOcero, PUZZLE model by Masquespacio. Dimensions: pieces of 580x580 mm/580x290 mm/290x290 mm/145x145mm and thickness 18 mm consisting of two panels of 9 mm thickness. The product allows for infinite combinations thanks to the modularity achieved through 4 different pieces, creating a Puzzle as a whole. Fixed using adhesive from the ECOcero brand. Available in 16 base colors. It is CE marked and certified with GOLD, FSC STANDARD, LEED, BREEAM, GLOBAL RECYCLED STANDARD, PEFC (ST 2002:2013), and OEKO-TEX STANDARD 100.

Panel acústico de fibra de poliéster reciclado gama ECO de la marca ECOcero modelo Puzzle by Masquespacio. Dimensiones: piezas de 580x580 mm/580x290 mm/290x290 mm/145x145mm y espesor 18 mm formada por dos paneles de 9 mm de espesor. El producto permite realizar infinitas combinaciones gracias a la modularidad que se realiza a través de 4 piezas de diferentes, creando un Puzzle en su conjunto. Fijación mediante adhesivo de la marca ECOcero. Disponible en 16 colores base. Marcado CE, con certificación GOLD, FSC STANDARD, LEED, BREEAM, GLOBAL RECYCLED STANDARD, PEFC (ST 2002:2013) y OEKO-TEX STANDARD 100.

## Absorption coefficient

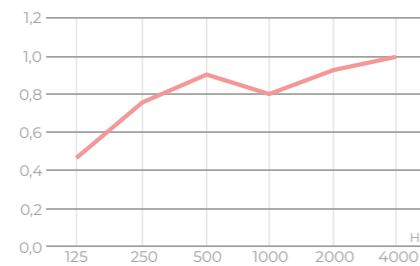

## Available thickness

18mm (9+9)

## Technical sheet

**Composition**  
Recycled textile fiber.

**Weight approx pack 22 U.**  
8,1 Kg

**Absorption**  
No air chamber ( $\alpha_w$  0.3)  
NRC: 0.45  
Air chamber 50 mm ( $\alpha_w$  0.75)  
NRC: 0.8  
Air chamber 200 mm ( $\alpha_w$  0.9)  
NRC: 0.85

**Cutting tolerance**  
 $\pm 2$  mm

**Fire resistance**  
B-s1-d0. Flame retardant.  
for public place.

## Complete composition example

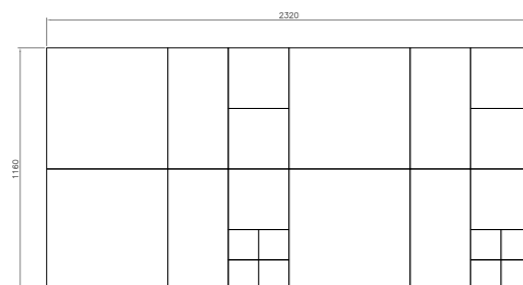

## Sizes and units available per pack

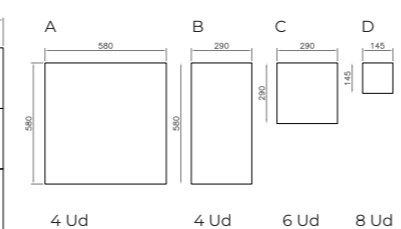

# Brezee by Noé Prades

ECOcollections



## Product description

A ceiling light designed by Noé Prades that mimics the spectrum of sound waves, consisting of an acoustic panel from ECOcero. Dimensions of the piece 2000x200 mm consisting of ribs made from 9 mm thick recycled polyester fiber acoustic panel from the ECO range of ECOcero. Available in 16 base colors. It is CE marked and certified with GOLD, FSC STANDARD, LEED, BREEAM, GLOBAL RECYCLED STANDARD, PEFC (ST 2002:2013), and OEKO-TEX STANDARD 100.

Luminaria de techo diseñada por Noé Prades que imita el espectro de las ondas del sonido, formada por panel acústico de la marca ECOcero. Dimensiones de la pieza 2000x200 mm formada por costillas panel acústico de fibra de poliéster reciclado de la gama ECO de la marca ECOcero, de 9 mm de espesor. Disponible en 16 colores base. Marcado CE, con certificación GOLD, FSC STANDARD, LEED, BREEAM, GLOBAL RECYCLED STANDARD, PEFC (ST 2002:2013) y OEKO-TEX STANDARD 100.

## Absorption coefficient

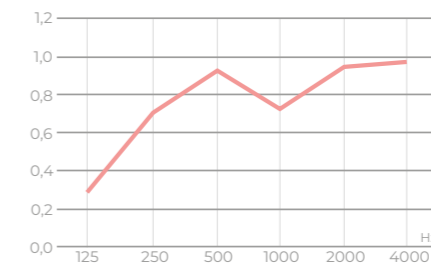

## Available thickness

9 mm

## Available Sizes

Long: 2000 mm  
Diameter: 200 mm

## Technical sheet

**Composition**  
Recycled textile fiber.

**Weight approx**  
3,8 Kg

**Absorption**  
No air chamber ( $\alpha_w$  0.25)  
NCR= 0.3  
Air chamber 200 mm ( $\alpha_w$  0.8)  
NCR= 0.80

**Cutting tolerance**  
 $\pm 2$  mm

**Fire resistance**  
B-s1-d0. Flame retardant.  
for public place.

# Colibrí by Noe Prades

ECOceiling

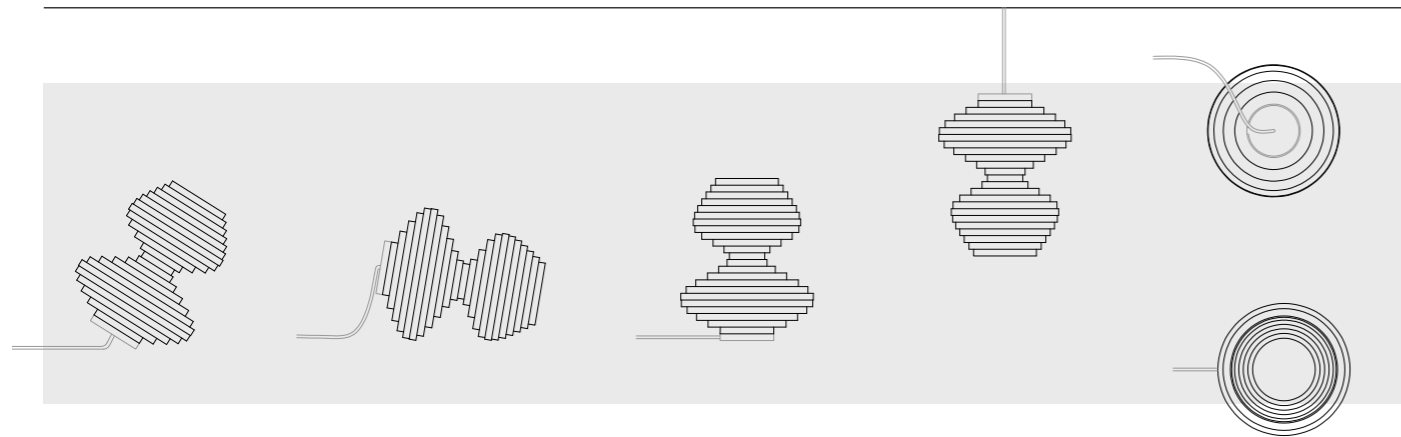

## Product description

COLIBRÍ is a set of 3 multi-position lights in different colors designed by Noe Prades, mimicking the sound waves of a hummingbird's song, consisting of an acoustic panel made of polyester fiber from the ECO range of ECOcero. Dimensions of the piece 216x176 mm and 9 mm thickness of the panel. Available in 16 base colors. It is CE marked and certified with GOLD, FSC STANDARD, LEED, BREEAM, GLOBAL RECYCLED STANDARD, PEFC (ST 2002:2013), and OEKO-TEX STANDARD 100.

COLIBRÍ es un conjunto de 3 luminarias de diferentes colores y multiposición diseñada por Noe Prades que imita las ondas del sonido del canto del colibrí, formada por panel acústico de fibra de poliéster de la gama ECO de la marca ECOcero. Dimensiones de la pieza 216x176 mm y de 9 mm de espesor de panel. Disponible en 16 colores base. Marcado CE, con certificación GOLD, FSC STANDARD, LEED, BREEAM, GLOBAL RECYCLED STANDARD, PEFC (ST 2002:2013) y OEKO-TEX STANDARD 100.

## Absorption coefficient

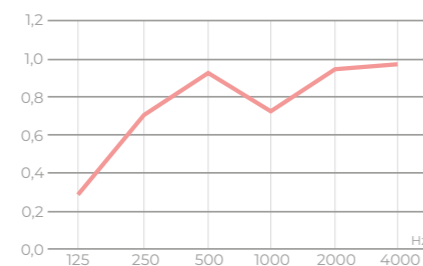

## Available thickness

— 9 mm

## Available Sizes

216 x 176 mm

## Technical sheet

**Composition**  
Recycled textile fiber.

**Weight approx**  
1,1 Kg

**Absorption**  
No air chamber ( $\alpha_w$  0.25)  
NRC: 0.3  
Air chamber 200 mm ( $\alpha_w$  0.8)  
NRC: 0.8

**Cutting tolerance**  
 $\pm 2$  mm

**Fire resistance**  
B-s1-d0. Flame retardant.  
for public place.



# Textures by Welcome Design | Print

ECOcollections  
ECOimagine



## Product description

The Texture and Print is a recycled polyester fiber acoustic panel from the ECO range of ECOcero, model ECOTexture by Welcome Design, available in catalog or customized designs, with a printed finish, dimensions of 2340x1170 mm, and a thickness of 12 mm. It includes a fixation system using contact adhesive from ECOcero for direct attachment to the support. It is CE marked and certified with GOLD, FSC STANDARD, LEED, BREEAM, GLOBAL RECYCLED STANDARD, PEFC (ST 2002:2013), and OEKO-TEX STANDARD 100.

Panel acústico de fibra de poliéster reciclada gama ECO de ECOcero, modelo ECOTexture by Welcome Design, diseño de catálogo o personalizado, acabado impreso, de medidas 2340x1170 mm, espesor 12 mm. Incluida p/p de sistema de fijación mediante cola de contacto de la marca ECOcero para fijación directa a soporte. Marcado CE, con certificado GOLD, FSC STANDARD, LEED, BREEAM, GLOBAL RECYCLED STANDARD, PEFC (ST 2002:2013) y OEKO-TEX STANDARD 100.

## Absorption coefficient

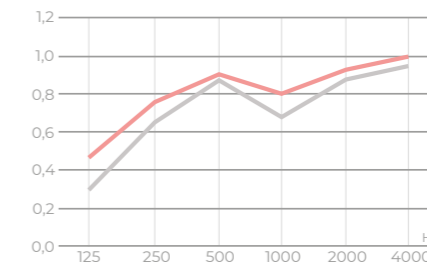

## Available thickness

— 9 mm  
— 12 mm

## Available Sizes

2340 mm x 1170 mm.  
Customized.

## Technical sheet

**Composition**  
Recycled textile fiber.

**Weight approx**  
9 mm: 4,1 Kg  
12 mm: 6,5 kg

**Absorption**  
9 mm  
No air chamber ( $\alpha_w$  0.25)  
NRC= 0.3  
Air chamber 200 mm ( $\alpha_w$  0.8)  
NRC= 0.80  
12 mm  
No air chamber ( $\alpha_w$  0.3)  
NRC= 0.45  
Air chamber 200 mm ( $\alpha_w$  0.9)  
NRC= 0.85

**Cutting tolerance**  
 $\pm 2$  mm

**Fire resistance**  
B-s1-d0. Flame retardant.  
for public place.



# OTOgreen wall

ECOcollections

by Rafa Ortega in collaboration with Greenarea



## Product description

Acoustic panels designed by Rafa Ortega with the collaboration of Greenarea, composed of preserved natural plants and a wall planter made from recycled polyester fiber acoustic panels from the ECO range of ECOcero, including a fixation system using contact adhesive from ECOcero for direct attachment to the wall. Available in 16 base colors. The acoustic panel forming the panels has a thickness of 18 mm (9+9 mm). It is CE marked and certified with GOLD, FSC STANDARD, LEED, BREEAM, GLOBAL RECYCLED STANDARD, PEFC (ST 2002:2013), and OEKO-TEX STANDARD 100.

Paneles acústicos diseñados por Rafa Ortega con la colaboración de Greenarea, compuesto por plantas naturales preservadas y macetero de pared fabricado mediante panel acústico de fibra de poliéster reciclada gama ECO de ECOcero, incluida p/p de sistema de fijación mediante cola de la marca ECOcero para fijación directa a paramento. Disponible 16 colores base. El panel acústico que forma los paneles será de 18 mm (9+9 mm) de espesor. Marcado CE, con certificado GOLD, FSC STANDARD, LEED, BREEAM, GLOBAL RECYCLED STANDARD, PEFC (ST 2002:2013) y OEKO-TEX STANDARD 100.

## Absorption coefficient

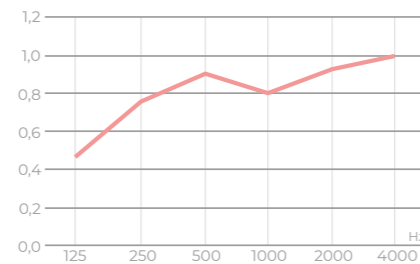

## Available thickness

18 mm (9+9)

## Available Sizes

MODEL A: 1150 x 475 mm  
MODEL B: 1150 x 950 mm

## Technical sheet

### Composition

Recycled textile fiber.

### Weight approx

1,7 kg/ 3,2 kg

### Absorption

No air chamber

( $\alpha_w$  0.3)

NRC: 0.45

Air chamber 50 mm

( $\alpha_w$  0.75)

NRC: 0.8

Air chamber 200 mm

( $\alpha_w$  0.9)

NRC: 0.8

### Cutting tolerance

$\pm$  2 mm

### Fire resistance

B-s1-d0. Flame retardant.  
for public place.

## ECOcollections | OTOgreen wall

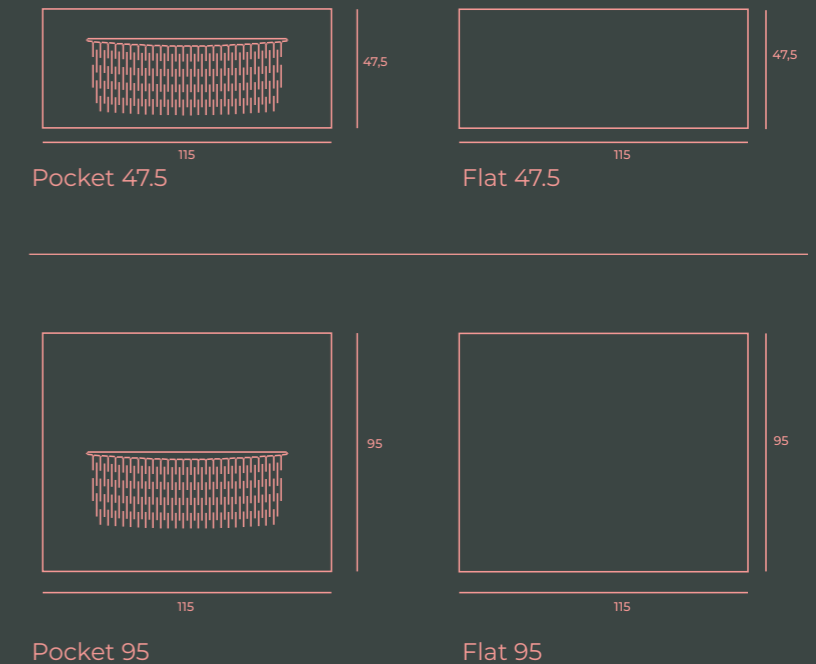

# OTOgreen planter

ECOcollections

by Rafa Ortega in collaboration with Greenarea



## Product description

Planters designed by Rafa Ortega with the collaboration of Greenarea, composed of acoustic panels made from recycled polyester fiber from the ECO range of ECOcero and preserved plants. Available in 16 base colors. The acoustic panel forming the planters has a thickness of 12 mm. It is CE marked and certified with GOLD, FSC STANDARD, LEED, BREEAM, GLOBAL RECYCLED STANDARD, PEFC (ST 2002:2013), and OEKO-TEX STANDARD 100.

Jardineras fonoabsorbentes de la marca Greenarea, compuesto por plantas naturales preservadas y macetero de pie fabricado mediante panel acústico de fibra de poliéster reciclada gama ECO de ECOcero®. Disponible en todos los colores de la gama ECO. El panel acústico que forma los maceteros será de 12 mm de espesor y dispondrá de marcado CE, Euroclase B-s1 d0 de reacción al fuego, cumplimiento con las especificaciones de bajas emisiones VOC con certificación GOLD en LEED y BREEAM. Jardineras también disponibles con ruedas o patas.

## Absorption coefficient

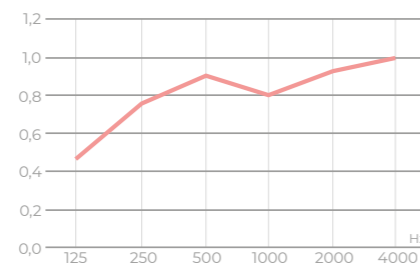

## Available thickness

— 12 mm

## Available Sizes

MODEL A: 1150 x 475 mm  
MODEL B: 1150 x 950 mm

## Technical sheet

### Composition

Recycled textile fiber.

### Weight approx

1,7 kg/ 3,2 kg

### Absorption

No air chamber (alpha\_w 0.3)  
NRC: 0.45  
Air chamber 50 mm (alpha\_w 0.75)  
NRC: 0.8  
Air chamber 200 mm (alpha\_w 0.9)  
NRC: 0.8

### Cutting tolerance

± 2 mm

### Fire resistance

B-s1-d0. Flame retardant. for public place.

## ECOcollections | OTOgreen planter

### Cube 30

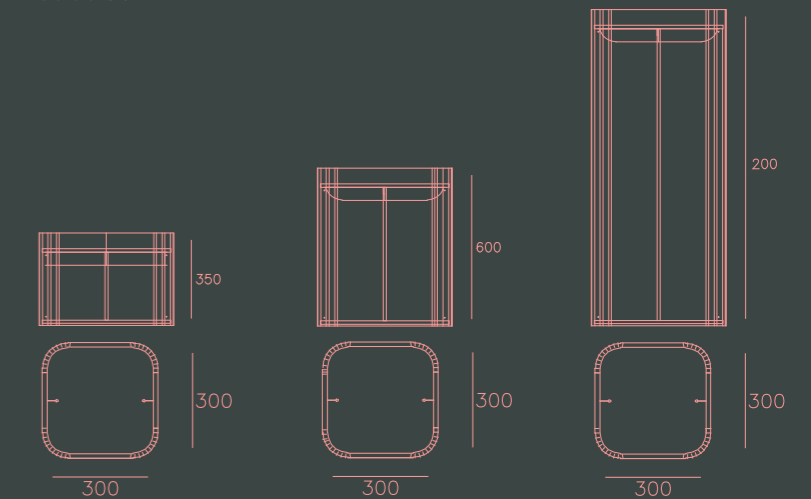

### Cube 51

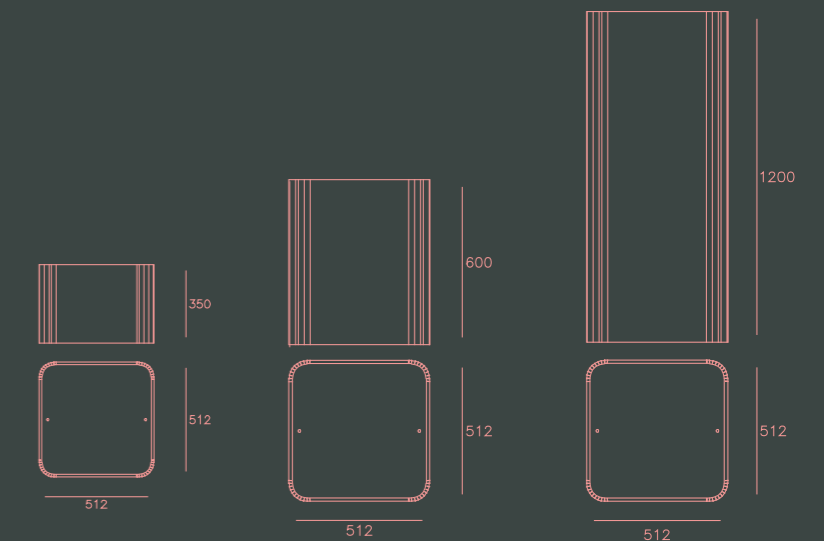

### Divider 108

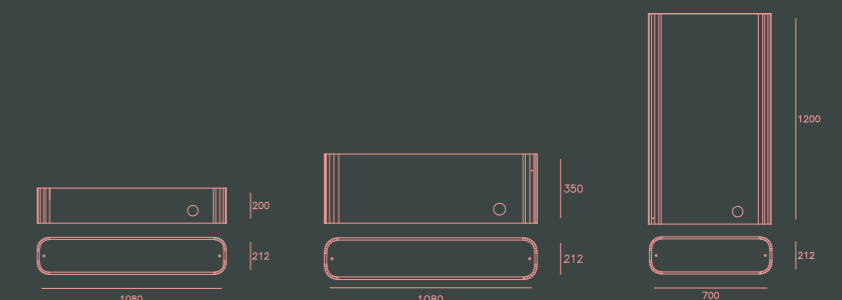

# Quiet

ECOollections



## Product description

A standing divider made from recycled polyester fiber acoustic panels from the ECO range of ECOcero, QUIET model with options for die-cut or V-cut, catalog design, 12 mm thickness, anchored with magnetic joints to posts made of white lacquered steel tube, 40 mm in diameter and a height of 1846 mm or 1350 mm on a circular plate of 350 mm in diameter and 5 mm thickness. Sound-absorbing panel available in 16 base colors. It is CE marked and certified with GOLD, FSC STANDARD, LEED, BREEAM, GLOBAL RECYCLED STANDARD, PEFC (ST 2002:2013), and OEKO-TEX STANDARD 100.

Divisorio de pie formado por panel acústico de fibra de poliéster reciclada gama ECO de la marca ECOcero, modelo QUIET posibilidad de Die-cut o V-cut, diseño de catálogo, espesor de 12 mm, anclado mediante uniones imantadas a postes de tubo de acero lacado en blanco, de 40 mm de diámetro y una altura de 1846 mm o 1350 mm sobre una placa circular de 350 mm de diámetro y 5 mm de espesor. Panel fonoabsorbente disponible en 16 colores base. Marcado CE, con certificado GOLD, FSC STANDARD, LEED, BREEAM, GLOBAL RECYCLED STANDARD, PEFC (ST 2002:2013) y OEKO-TEX STANDARD 100.

## Absorption coefficient

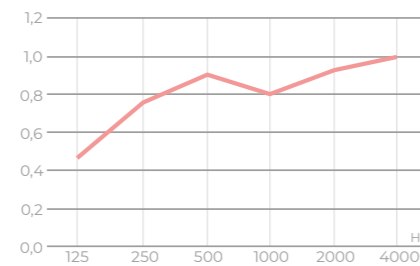

## Available thickness

— 12 mm

## Available Sizes

Quiet simple  
1261 x 1388 mm or 1261 x 1904 mm  
Quiet double  
1180 x 1386 mm or 1180 x 1902 mm

## Technical sheet

### Composition

Recycled textile fiber.

### Weight approx

1,7 kg/ 3,2 kg

### Absorption

No air chamber  
(alpha\_w 0.3)  
NRC: 0.45  
Air chamber 50 mm  
(alpha\_w 0.75)  
NRC: 0.8  
Air chamber 200 mm  
(alpha\_w 0.9)  
NRC: 0.85

### Cutting tolerance

± 2 mm

### Fire resistance

B-s1-d0. Flame retardant.  
for public place.

## Example positions

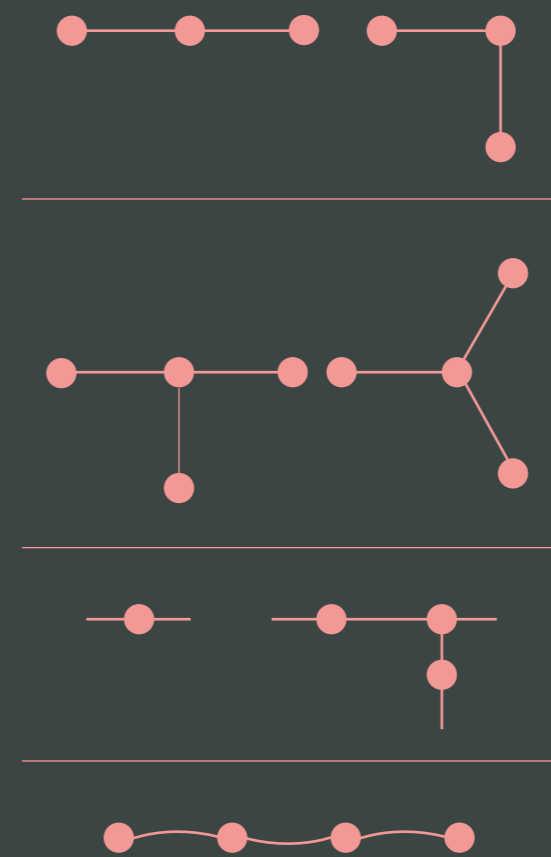

## Models

### Quiet Die-cut

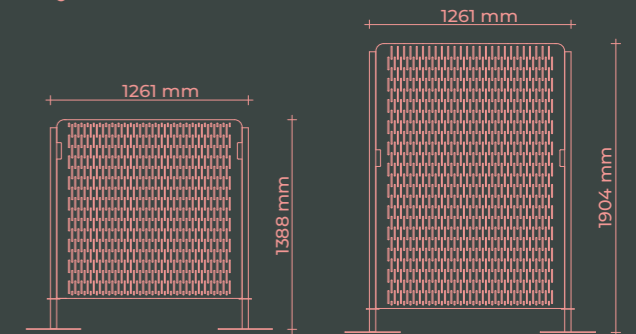

### Quiet V-cut

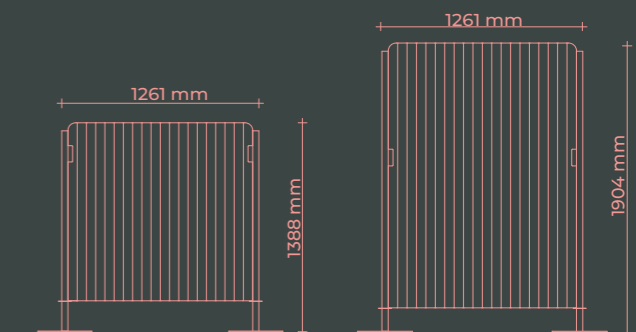

### Quiet Double

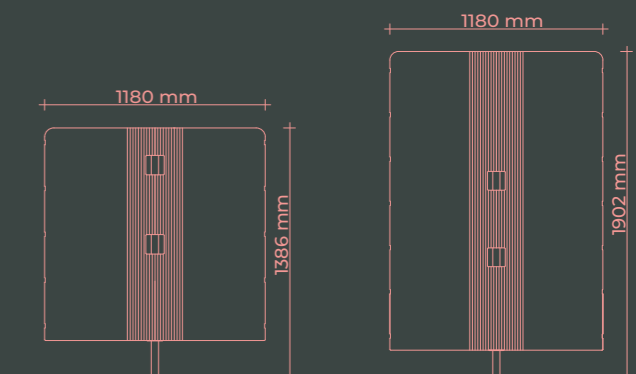

# Sweet home

ECObooth



## Product description

The Sweet Home soundproof booth by ECOcero is designed for well-being, thanks to its acoustic insulation, silent ventilation system, and acoustic conditioning with 9 mm thick absorption panels. This is a portable cabin that is easy to assemble and disassemble with a hydraulic closing system and motion sensor light for greater energy savings. The estimated assembly time is 40 minutes. No screws, nails, or glue are required. Available in 3 finish colors: beige, light gray, and anthracite gray. Certifications include ISO 9001:2015, ISO 14067:2018, ASTM E84-19a, AS/NZS 4088.1:1996 Reconfirmed 2013, CE (EN IEC 55015:2019, 2014/35/EU, and 2014/30/EU, UNE-EN 717-1:2004, PEFC ANSI/BIFMA X5.4-2020, and acoustic certification.

Cabina insonorizada de la marca ECOcero modelo Sweet Home, pensada para el bienestar gracias a su aislamiento acústico, sistema de ventilación silencioso, y acondicionamiento acústico con paneles de absorción de 9 mm de grosor. Esta es una cabina portátil de fácil montaje y desmontaje con sistema de cierre hidráulico y sensor luz de movimiento para un mayor ahorro energético. Tiempo estimado de montaje 40 minutos. No se requieren tornillos, clavos o pegamento. Disponible en 3 colores de acabados: beige, gris claro y gris antracita. Certificados: ISO 9001:2015, ISO 14067:2018, ASTM E84-19a y AS/NZS 4088.1:1996 Reconfirmed 2013, CE (EN IEC 55015:2019, 2014/35/EU y 2014/30/EU, UNE-EN 717-1:2004, PEFC ANSI/BIFMA X5.4-2020 y certificado acústico.

## Absorption coefficient

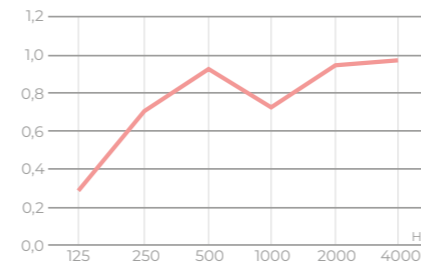

## Available thickness

— 9 mm

## Available Sizes

External size  
W1100 x D900 x H2100mm  
Internal size  
W1000 x D800 x H1960 mm.  
Weight: 246 kg



## Technical sheet

### Sound insulation

Generates an ideal work environment and a concentration space. Sound insulation. STC:26 DB (+-3DB)

### Ventilation

Silent ventilation system by impulse that has a rotation speed of up to 1500 rpm and a ventilation efficiency greater than 30m<sup>3</sup>/h.

### Lighting

Daylight LED light bar of 4000K (150Lx) on the top, 3.5W 170LM. The reading lamp uses light Dimmable daylight LED in temperature from 3000K to 6500K, 5W 160LM

### 110-220V Power

Requires a power supply of 110-220V for ventilation and lighting. It has a power outlet in the interior, as well as a charging installation 12V USB  
Connections: USB-A and USB-C connectivity, power outlet and internet connection

### Acoustic Conditioning

Interior lining with panels of 9 mm thick sound absorption that provides acoustic comfort in addition to a reduction of the noise of the environment. Reverberation time: 0.13s (± 0.1s)

## Colours



ANTHRACITE  
GRAY

LIGHT  
GRAY



BEIGE



# Square

ECObasics



## Product description

The Square is a recycled polyester fiber acoustic panel from the ECO range of ECOcero, model ECObasic SQUARE, catalog design, with dimensions of 585x585 mm, 780x780 mm, 1000x1000 mm, and 1170x1170mm, and a thickness of 24 mm. It includes a fixation system using contact adhesive from ECOcero for direct attachment to the support. Available in 2 base colors (white and black), with the option of painting in any color from the RAL or NCS charts. It is CE marked and certified with GOLD, FSC STANDARD, LEED, BREEAM, GLOBAL RECYCLED STANDARD, PEFC (ST 2002:2013), and OEKO-TEX STANDARD 100.

Panel acústico de fibra de poliéster reciclada gama ECO de la marca ECOcero, modelo ECObasic SQUARE, diseño de catálogo, de medidas 585x585 mm, 780x780 mm, 1000x1000 mm y 1170x1170mm, espesor 24 mm. Incluida p/p de sistema de fijación mediante cola de contacto de la marca ECOcero para fijación directa a soporte. Disponible en 2 colores base (blanco y negro), y posibilidad de pintado en cualquier color de la carta RAL o NCS. Marcado CE, con certificado GOLD, FSC STANDARD, LEED, BREEAM, GLOBAL RECYCLED STANDARD, PEFC (ST 2002:2013) y OEKO-TEX STANDARD 100.

## Absorption coefficient

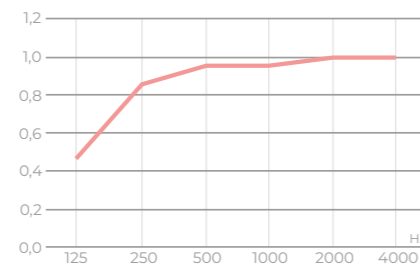

## Available thickness

— 24 mm

## Available Sizes

585 x 585 mm  
780 x 780 mm  
1000 x 1000 mm  
1170 x 1170 mm

## Available Colours

ECO-104  
ECO-127  
NCS or RAL of choice

## Technical sheet

**Composition**  
Recycled textile fiber.

**Weight approx**  
1,4 kg a 5,5 kg

**Absorption**  
No air chamber  
( $\alpha_w$  0.5)  
NRC: 0.7  
Air chamber 200 mm  
( $\alpha_w$  1)  
NRC: 0.95

**Cutting tolerance**  
 $\pm$  2 mm

**Fire resistance**  
B-s1-d0. Flame retardant.  
for public place.

# Circle

ECObasics



## Product description

The Circle is a recycled polyester fiber acoustic panel from the ECO range of ECOcero, model ECObasic CIRCLE, catalog design, supplied in a pack of 10 circles with a diameter of 585 mm, 12 circles with a diameter of 390 mm, and 24 circles with a diameter of 190 mm, thickness 24 mm. It includes a fixation system using contact adhesive from ECOcero for direct attachment to the support. Available in 2 base colors (white and black), with the possibility of painting in any color from the RAL or NCS charts. It is CE marked and certified with GOLD, FSC STANDARD, LEED, BREEAM, GLOBAL RECYCLED STANDARD, PEFC (ST 2002:2013), and OEKO-TEX STANDARD 100.

Panel acústico de fibra de poliéster reciclada gama ECO de la marca ECOcero, modelo ECObasic CIRCLE, diseño de catálogo, suministrado en pack de 10 círculos de diámetro 585 mm, 12 círculos de diámetro 390 mm y 24 círculos de diámetro 190 mm, espesor 24 mm. Incluida p/p de sistema de fijación mediante cola de contacto de la marca ECOcero para fijación directa a soporte. Disponible en 2 colores base (blanco y negro), y posibilidad de pintado en cualquier color de la carta RAL o NCS. Marcado CE, con certificado GOLD, FSC STANDARD, LEED, BREEAM, GLOBAL RECYCLED STANDARD, PEFC (ST 2002:2013) y OEKO-TEX STANDARD 100.

## Absorption coefficient

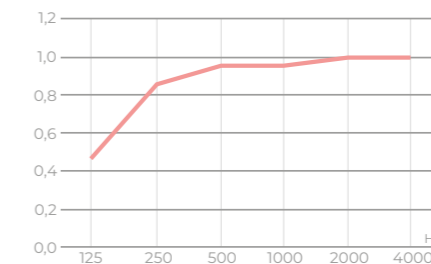

## Available thickness

— 24 mm

## Available Sizes Circle pack

10 U. D585 mm  
12 U. D390 mm  
24 U. D190 mm

## Available Colours

ECO-104  
ECO-127  
NCS or RAL of choice

## Technical sheet

**Composition**  
Recycled textile fiber.

**Weight approx**  
18 kg

**Absorption**  
No air chamber  
( $\alpha_w$  0.5)  
NRC: 0.7  
Air chamber 200 mm  
( $\alpha_w$  1)  
NRC: 0.95

**Cutting tolerance**  
 $\pm$  2 mm

**Fire resistance**  
B-s1-d0. Flame retardant.  
for public place.

# Rectangle

ECObasics



## Product description

The RECTANGLE is a recycled polyester fiber acoustic panel from the ECO range of ECOcero, model ECObasic RECTANGLE, catalog design, dimensions 585X1170 mm, thickness 24 mm. It includes a fixation system using contact adhesive from ECOcero for direct attachment to the support. Available in 2 base colors (white and black), with the possibility of painting in any color from the RAL or NCS charts. It is CE marked and certified with GOLD, FSC STANDARD, LEED, BREEAM, GLOBAL RECYCLED STANDARD, PEFC (ST 2002:2013), and OEKO-TEX STANDARD 100.

Panel acústico de fibra de poliéster reciclada gama ECO de la marca ECOcero, modelo ECObasic RECTANGLE, diseño de catálogo, de medidas 585X1170 mm, espesor 24 mm. Incluida p/p de sistema de fijación mediante cola de contacto de la marca ECOcero para fijación directa a soporte. Disponible en 2 colores base (blanco y negro), y posibilidad de pintado en cualquier color de la carta RAL o NCS. Marcado CE, con certificado GOLD, FSC STANDARD, LEED, BREEAM, GLOBAL RECYCLED STANDARD, PEFC (ST 2002:2013) y OEKO-TEX STANDARD 100.

## Absorption coefficient

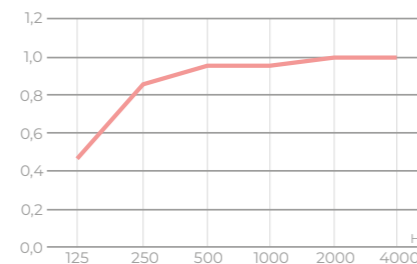

## Available thickness

— 24 mm

## Available Sizes

585 x 1170 mm

## Available Colours

ECO-104  
ECO-127

**NCS or RAL of choice**

## Technical sheet

**Composition**  
Recycled textile fiber.

**Weight approx**  
2,7 kg

**Absorption**  
No air chamber  
( $\alpha_w$  0.5)  
NRC: 0.7  
Air chamber 200 mm  
( $\alpha_w$  1)  
NRC: 0.95

**Cutting tolerance**  
 $\pm$  2 mm

**Fire resistance**  
B-s1-d0. Flame retardant.  
for public place.

# Colours



ECO-116



ECO-139

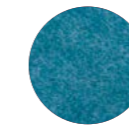

ECO-124

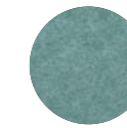

ECO-140



ECO-108



ECO-131



ECO-149



ECO-112



ECO-101



ECO-107



ECO-127



ECO-125



ECO-123



ECO-138



ECO-136



ECO-104

Beyond the 16 colors of the ECO range, with their soft pastel hues designed to evoke emotions, we offer custom painting in any color from the RAL and NCS palettes. Our special paint ensures total absorption and acoustic conditioning.

Más allá de los 16 colores de la gama ECO, con sus suaves tonos pastel diseñados para generar emociones, ofrecemos pintura personalizada en cualquier color de las paletas RAL y NCS. Nuestra pintura especial asegura una total absorción y acondicionamiento acústico.

# Anchors and accessories



**ECO line Adhesive** Polyurethane adhesive for direct fixing of the panel to walls and ceilings.— **290ml**



**Anchor C** to hang 9-12 mm thickness suspended panel with steel cable. Adjusted included (from 150 mm to 2000 mm).

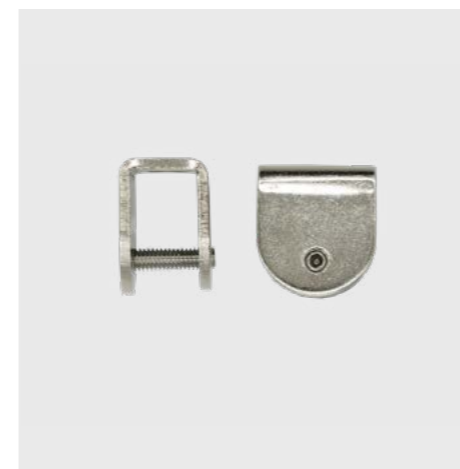

**Anchor D** to hang 9-12 mm thickness direct ceiling panel with steel cable. — **20 x 20 x 15 mm**



**Anchor B** with steel cable and height. Adjusted included (from 150 mm to 2000 mm).



**Anchor M** for for ECOWorking on tables up to 25 mm of thickness. — **43 x 33 x 93 mm**



**Anchor S** to be installed on table top for ECOWorking. — **43 x 33 x 59 mm**



In a world where the noise of everyday life often disconnects us, **ECOcero** invites you to reconnect, to rediscover the symbiosis between the environment and your sensations. With each acoustic panel, we weave a future where nature flows in our spaces. Imagine a place where you inspire a deeper and more meaningful connection with our surroundings and the emotions it evokes in us. It's a vision of the future, a convergence of innovation and sustainability, paving the way toward a more harmonious and balanced world.

En un mundo donde el ruido de la cotidianidad a menudo nos desconecta, **ECOcero** te invita a reencontrarte, a redescubrir la simbiosis entre el ambiente y tus sensaciones. Con cada panel acústico tejemos un futuro donde la naturaleza fluye en nuestros espacios. Imagina un lugar donde inspirar una conexión más profunda y significativa con nuestro entorno y las emociones que nos evoca. Es una visión de futuro, una convergencia de innovación y sostenibilidad, trazando un camino hacia un mundo más armónico y equilibrado.

