

# FEDERICO GINER

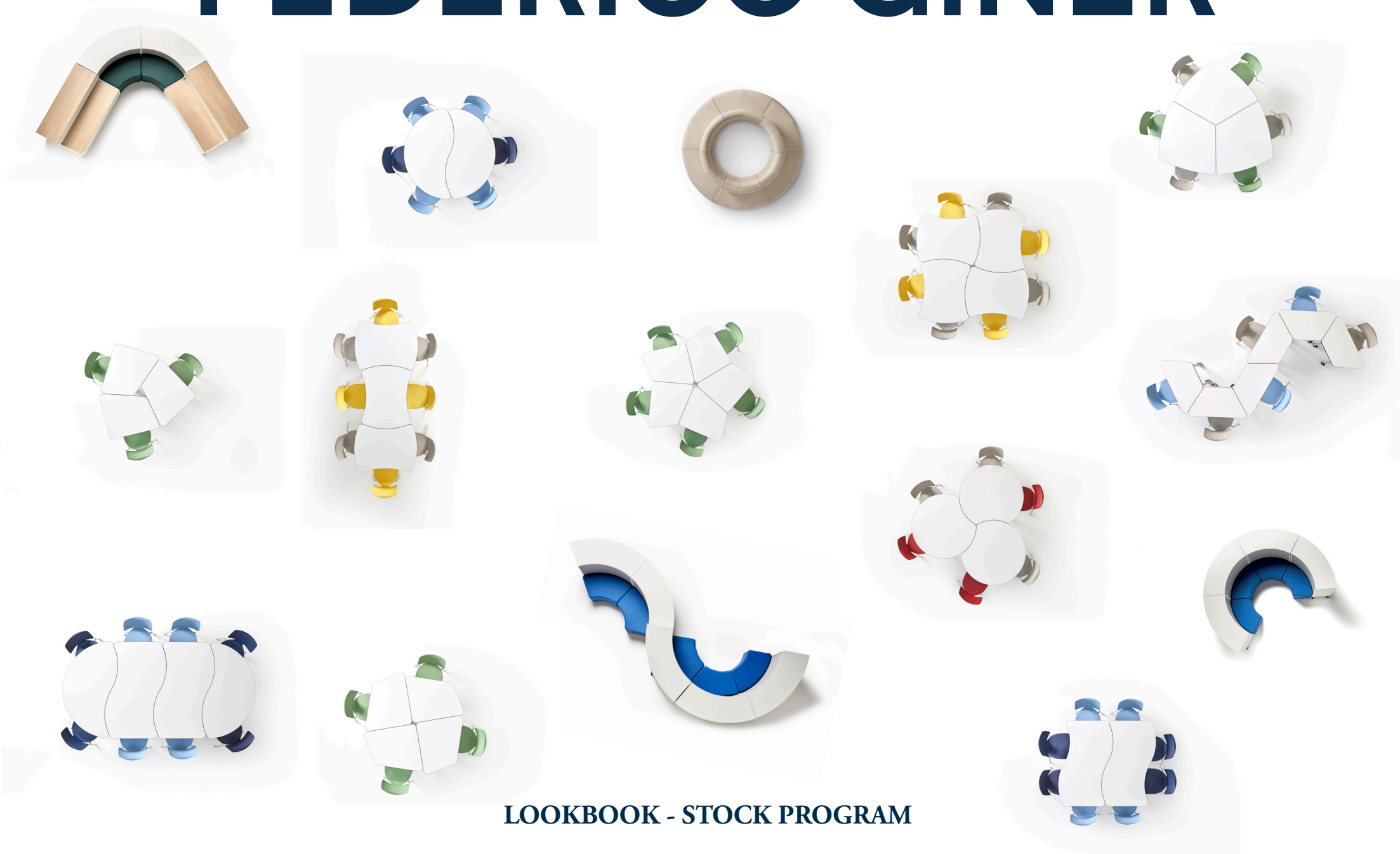

LOOKBOOK - STOCK PROGRAM



FEDERICO GINER  
desde 1910



# Contenido

## Content

- 01 Why FG?
- 02 Spaces
- 03 Products
- 04 Size Guide
- 05 Finishes

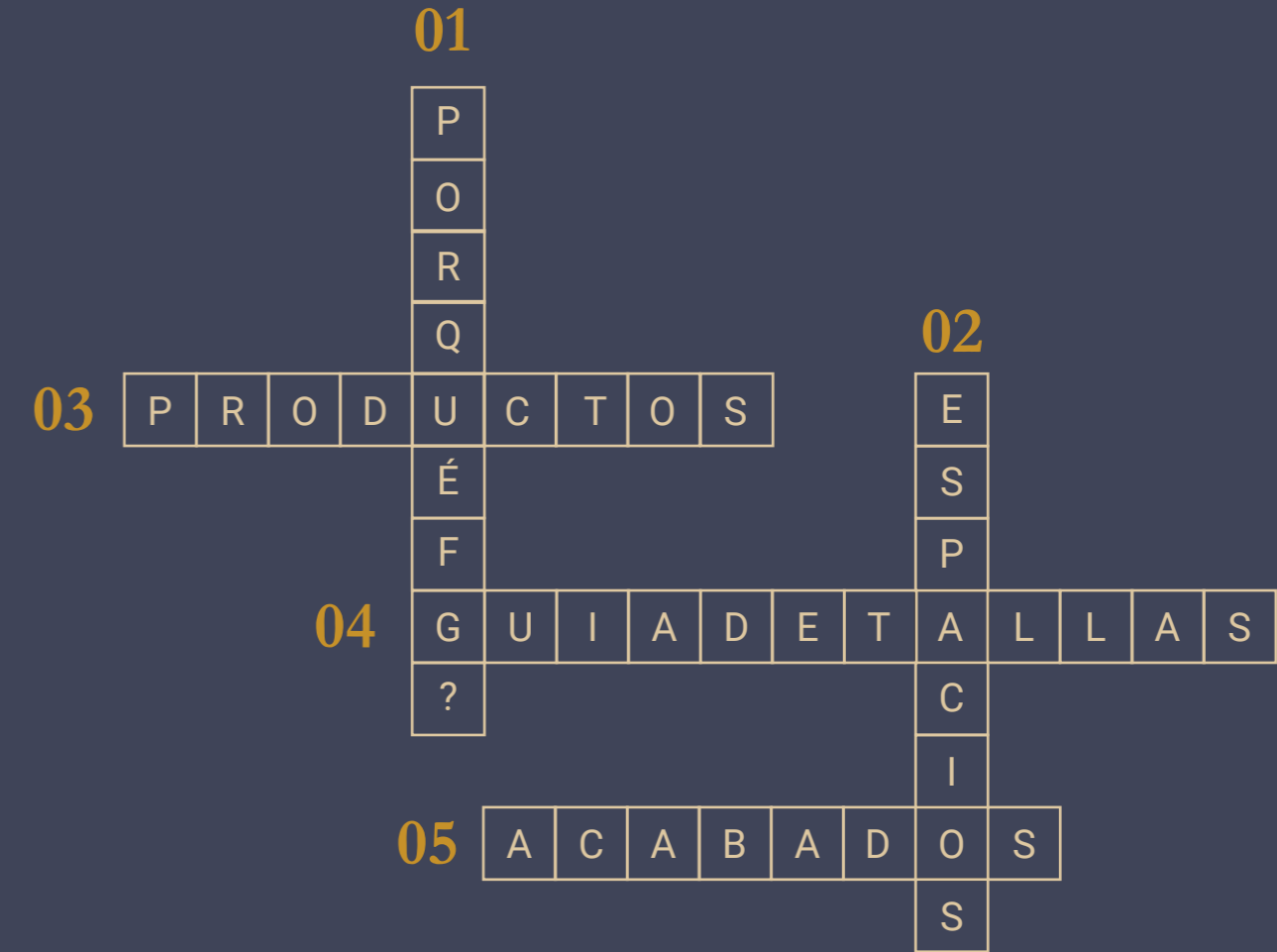





# 01

P	T	B	C	B	O	P	V	L	C	O	E	L	O
C	Y	O	<b>P</b>	A	Ñ	C	K	W	B	A	Q	E	A
Q	C	Ñ	<b>O</b>	Ñ	W	Q	C	D	R	K	S	Z	K
R	N	B	<b>R</b>	P	T	R	A	N	X	Y	T	K	Y
Y	X	O	<b>Q</b>	A	B	Y	M	O	P	R	Y	O	R
C	U	M	<b>U</b>	X	W	C	T	P	Y	A	N	E	A
L	Ñ	B	<b>É</b>	Z	B	L	Ñ	V	U	I	L	P	I
C	P	I	<b>F</b>	T	L	C	L	N	Z	Ñ	A	P	Ñ
C	Q	H	<b>G</b>	A	B	C	A	G	X	J	W	E	J
C	Y	G	<b>?</b>	B	V	C	C	H	L	K	P	L	K
C	L	I	C	R	Q	C	O	K	R	L	W	C	L
M	Y	K	C	E	Z	M	P	B	W	M	V	P	M



**FEDERICO GINER**, una marca ligada a la historia de la educación en España en los últimos cien años, se ha convertido en todo un referente en el sector de la educación, tanto a nivel nacional como internacional, ya que ha sabido reinventarse para hacer frente a las demandas y necesidades de un mundo cada vez más cambiante. Y es que, la flexibilidad en el diseño, la producción y el testeo de sus productos, han hecho de **FEDERICO GINER** una marca que se ha convertido en sinónimo de máxima calidad y trabajo bien hecho.

**FEDERICO GINER**, a brand linked to the history of education in Spain in the last hundred years, has become a benchmark in the education sector, both nationally and internationally, and to which has managed to reinvent itself to cope to the demands and needs of an increasingly changing world. And is that, the flexibility in design, production and the testing of their products, have made **FEDERICO GINER** a brand that has become synonymous with top quality and work well done.



**Federico Giner** pone en marcha el primer taller de carpintería de Tavernes de la Valldigna (Valencia), el embrión de un negocio de base industrial que actualmente es todo un referente en el sector de la fabricación de mobiliario escolar e instalaciones. Sus productos siempre se han definido por su calidad, perdurabilidad y funcionalidad.

**Federico Giner** established the first carpenter workshop in Tavernes de la Valldigna (Valencia), the birth of an industrial based business which is nowadays a benchmark in the manufacturing sector for school furniture and fixtures. Their products are renowned for their quality durability and functionality.



### Llega la homologación escolar

*The school endorsement arrives*

El Ministerio de Educación crea una nueva normalización en la fabricación del mobiliario escolar que la empresa aborda de manera inmediata. Al mismo tiempo, consolida su presencia internacional a través de ferias y certámenes por todo el mundo.

*The Ministry of Education introduces new regulations to school furniture production which the company immediately adopts. At the same time the company's international presence is consolidated by participating in international fairs and tenders.*

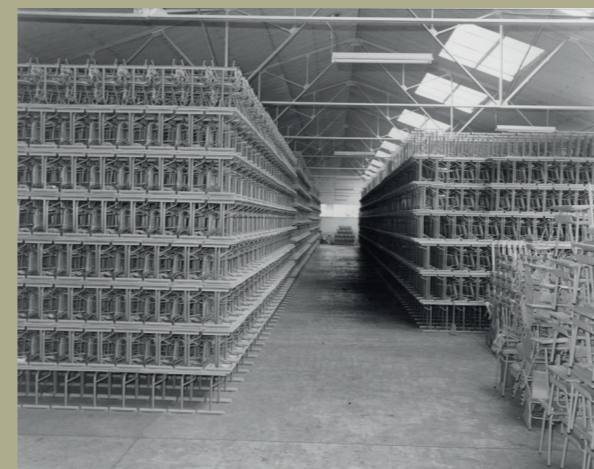

### Colaboración con Institutos Tecnológicos

*Collaboration with technological institutions*

Se inicia una estrecha relación con AIDIMA e IBV de Valencia, con el objetivo de no cesar en la investigación y desarrollo en el mobiliario escolar. En estos años, se amplía la oferta con el mueble para Universidad y la fabricación de carros portaequipajes en aeropuertos.

*A close line of communication is formed with Valencia AIDIMA and IBV with the aim of continuous research and development of school furniture. During this period the range of products is expanded to include university furniture and airport trolleys.*



1910

1975

1992

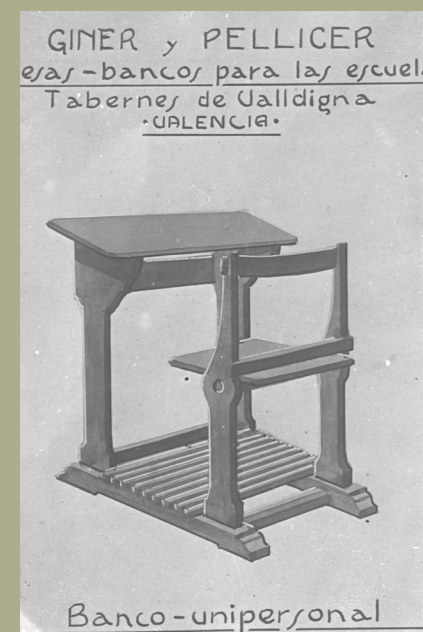

1926

### Especialización por el mobiliario escolar

*Specializing in school furniture*

Comienza la participación de Federico Giner en las convocatorias de concursos para suministro de muebles escolares del Ministerio de Educación, un hecho que marcará la especialización de la firma y su trayectoria.

Federico Giner starts tendering for school furniture contracts with the Ministry of Education, an event which marks the beginning of specialization in the company and its industrial projection.



1989

### El nacimiento de un parque empresarial

*The birth of a business park*

Con el crecimiento de la empresa, se construyen nuevas instalaciones y se crea una red de empresas auxiliares que configuran un tejido industrial alrededor de la firma. Esta se apoya en la colaboración de diseñadores externos que aportan un toque de frescura al mobiliario de hogar y educativo.

*With the growth of the company, new installations are constructed and an auxiliary network of companies is created, which forms an industrial web around the company. This is supported by the collaboration of external designers who bring a fresh approach to school and household furniture design.*



2023

### Un nuevo enfoque

*A new approach*

Federico Giner apuesta por la innovación y la internacionalización. Lanzamiento de nuevo catálogo, fruto de constantes inversiones durante los últimos 5 años en colaboración con prestigiosos diseñadores. El objetivo de los próximos años es estar presente en ferias internacionales y seguir innovando con el fin de dar a conocer los valores y atributos de los productos FG fuera de nuestras fronteras.

*Federico Giner is committed to innovation and internationalization. Launch of a new catalog, the result of constant investments over the past 5 years in collaboration with prestigious designers. The objective of the coming years is to be present at international fairs and to continue innovating in order to the values and attributes of FG products outside our borders.*



## Calidad Federico Giner

Una inversión en productos FG, es una inversión en calidad que ha sido probada a lo largo de los años y que es respaldada con garantías comprobadas.

Factores a tomar en cuenta:

- Funcionalidad del producto en relación a la necesidad a cubrir.
- Medidas adecuadas al usuario según normativa.
- Acabados y materiales para uso intensivo en espacio públicos.
- Mantenimientos y garantía de reposición.

An investment in FG products, is an investment in quality that has been proven over the years and is backed with proven warranties.

Factors to take into account:

- Functionality of the product in relation to the need to be covered.
- Adequate measures to the user according to regulations.
- Finishes and materials for intensive use in public spaces.
- Maintenance and replacement guarantee.

### Garantía FG Warranty



Pupitres y colección Postura+  
Desks and Postura+ collection



Mesas y sillas  
Tables and chairs



Productos móviles  
Mobile products



Otras empresas  
Other companies

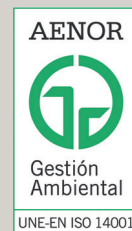

\*Consultar más información sobre garantía de cada producto en : [info@federicoginer.com](mailto:info@federicoginer.com)  
\*Consult more information on the warranty of each product at [info@federicoginer.com](mailto:info@federicoginer.com)

FEDERICO GINER  
desde 1910



Fabricado en España  
Made in Spain



Productos certificados con  
normativa Europea  
Products certified with European  
standards



Fabricación de calidad  
Quality manufacturing



Proveedor oficial  
Official supplier



Diseño de aulas y proyectos  
personalizados  
Classroom design and customized  
projects



Servicio rápido de entrega  
Quick ship delivery





# 02

P	T	B	A	B	O	P	V	L	C	O	E	L	O
C	Y	O	B	A	Ñ	C	K	W	B	A	Q	E	A
Q	C	Ñ	A	Ñ	W	Q	C	D	R	K	S	Z	K
R	N	B	<b>E</b>	<b>S</b>	<b>P</b>	<b>A</b>	<b>C</b>	<b>I</b>	<b>O</b>	<b>S</b>	T	K	Y
Y	X	O	S	A	B	Y	M	O	P	R	Y	O	R
C	U	M	P	X	W	C	T	P	Y	A	N	E	A
L	Ñ	B	A	Z	B	L	Ñ	V	U	I	L	P	I
C	P	I	C	T	L	C	L	N	Z	Ñ	A	P	Ñ
C	Q	H	I	A	B	C	A	G	X	J	W	E	J
C	Y	G	O	B	V	C	C	H	L	K	P	L	K
C	L	I	S	R	Q	C	O	K	R	L	W	C	L
M	Y	K	R	E	Z	M	P	B	W	M	V	P	M





# Aula del futuro

Future classroom lab.

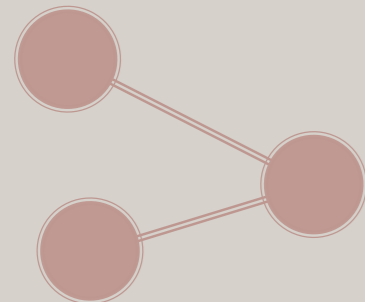

El aula del futuro se concibe como un espacio creativo donde el alumnado encuentra todo aquello que necesita para experimentar múltiples y diversas experiencias de aprendizaje. Contempla aulas muy versátiles, espacios abiertos, multifuncionales y con mobiliario modular móvil que permita la creación de diversas zonas. Las zonas de aprendizaje de un espacio creativo no han de ser concebidas de forma rígida, sino flexible y adaptable a cada necesidad. En muchos casos no siempre están presentes todas las zonas de forma individual, sino que pueden solaparse unas con otras en función de los medios y la necesidad, lo mismo que para los diferentes elementos tecnológicos. A continuación, se definen las zonas de aprendizaje establecidas en el modelo del aula del futuro.

**Interacción:** Equipada con una pizarra interactiva, esta zona ilustra cómo utilizar la tecnología en un aula tradicional para fomentar la interacción y la participación de los alumnos. Proporciona la oportunidad de experimentar formas de enseñanza y un aprendizaje más interactivo dentro de un entorno tradicional con la ayuda de hardware, software y contenidos específicos.

PROVEEDOR OFICIAL  
aula del futuro



**Future classroom lab**, is conceived as a creative space where students find everything they need to experience multiple and diverse learning experiences. It envisions highly versatile classrooms, open spaces, multifunctional and with mobile modular furniture that allows the creation of different zones. The learning areas of a creative space should not be conceived in a rigid way, but flexible and adaptable to every need. In many cases, not all zones are always present individually, but can overlap with each other depending on the means and the need, as well as for the different technological elements. The following defines the learning zones established in the model of the classroom of the future.

**Interaction:** Equipped with an interactive whiteboard, this area illustrates how technology can be used in a traditional classroom to encourage student interaction and participation. It provides the opportunity to experience ways of teaching and more interactive learning within a traditional environment with the help of specific hardware, software and content.

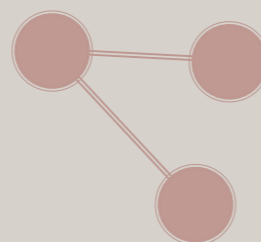



**Intercambio:** Un área particularmente diseñada para desarrollar trabajo en pequeños grupos con la supervisión del profesor. Es ideal para desarrollar trabajos colaborativos y apoyar escenarios de aprendizaje basados en proyectos, fomentando los equipos de trabajo y las habilidades para la dirección de proyectos específicos.

**Exchange:** An area particularly designed to develop work in small groups with teacher supervision. It is ideal for developing collaborative work and supporting project-based learning scenarios, fostering teamwork and project management skills.



**Presentación:** Un área para que el profesorado y el alumnado lleven a cabo las presentaciones de sus trabajos, sus investigaciones, etc. Dispone de una pizarra digital y bancos en gradas, lo que permite a todas las personas participantes verse entre sí, como en un foro, y favorece la participación y la discusión.

**Presentation:** An area for teachers and students to carry out presentations of their work, research, etc. It has a digital whiteboard and benches on bleachers, which allows all participants to see each other, as in a forum, and encourages participation and discussion.

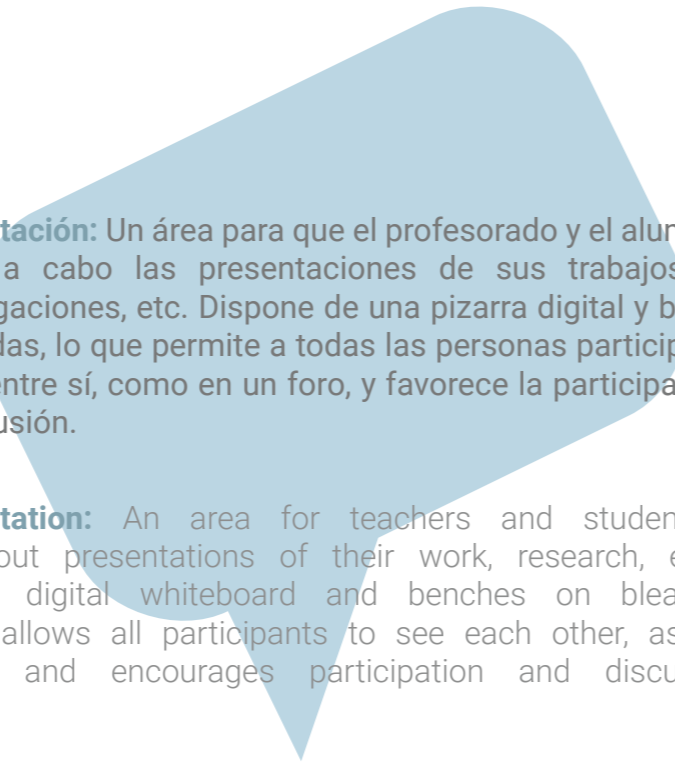

**Desarrolla:** Una zona tranquila donde los alumnos acceden a distintos recursos, realizan investigaciones, trabajan individualmente y aprenden de modo informal. Esta zona se puede usar para desdibujar los límites entre el aprendizaje en casa y en la escuela y, entre otras actividades, se pueden realizar manualidades, ver videos, o experimentar con aplicaciones de software.

**Develop:** A quiet area where students access resources, conduct research, work individually and learn informally. This area can be used to blur the boundaries between learning at home and at school and, among other activities, students can do crafts, watch videos, or experiment with software applications.



**Investigación:** Una zona flexible para el trabajo en grupo, el desarrollo de proyectos y actividades prácticas. Este espacio es idóneo para trabajar con los compañeros, explorar, investigar pequeños objetos usando los ordenadores portátiles y los microscopios, desarrollar habilidades para la resolución de problemas o la programación con robots.

**Research:** A flexible area for group work, project development and hands-on activities. This space is ideal for working with peers, exploring, investigating small objects using laptops and microscopes, developing problem-solving skills or programming with robots.







## Aula del futuro 80m2

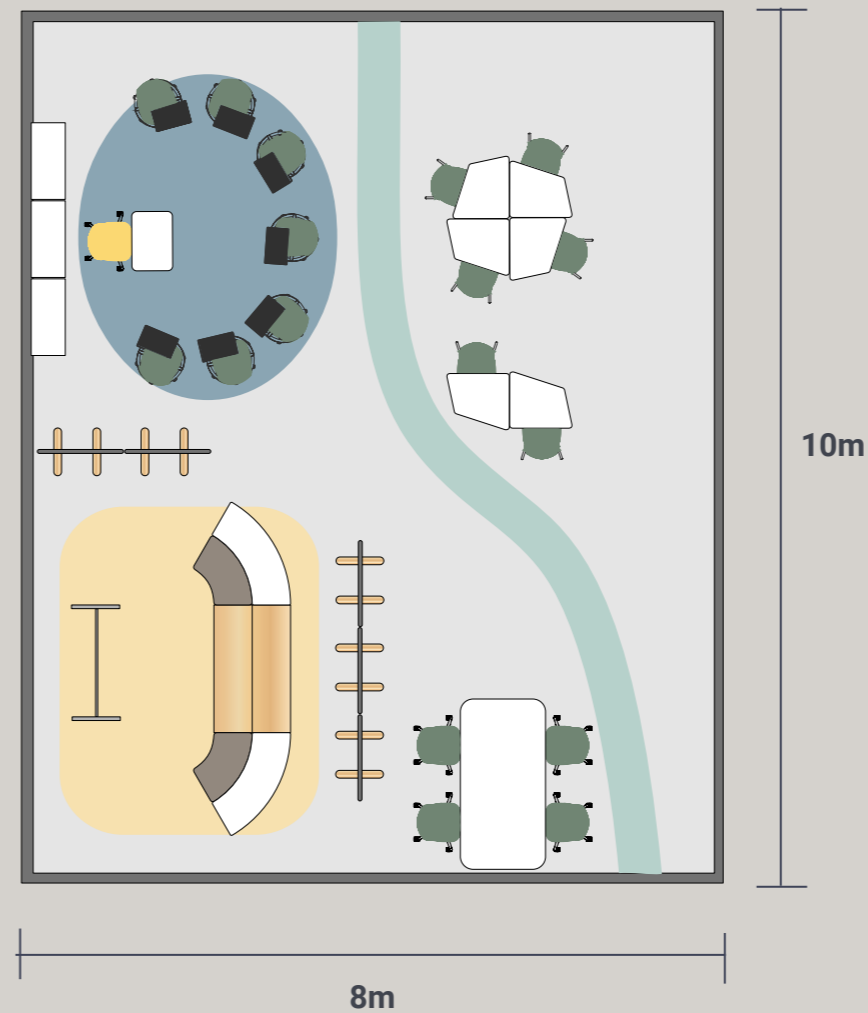

### Zona Interacción



Taburete DIDA  
TAC580



Mesa Alta  
MCA200

### Zona Investigación



Silla DIDA  
SAC500



Pupitre 345  
MAB345

### Zona Presentación



Armario Curvo  
AAC115



Softseating Curvo  
BAC110



Grada  
GAC100

### Zona Intercambio



Mesa Tutor  
MPA100



Taburete DIDA  
TAC580



Armario Gavetero  
ASN306



DIDA Basket  
SAC590



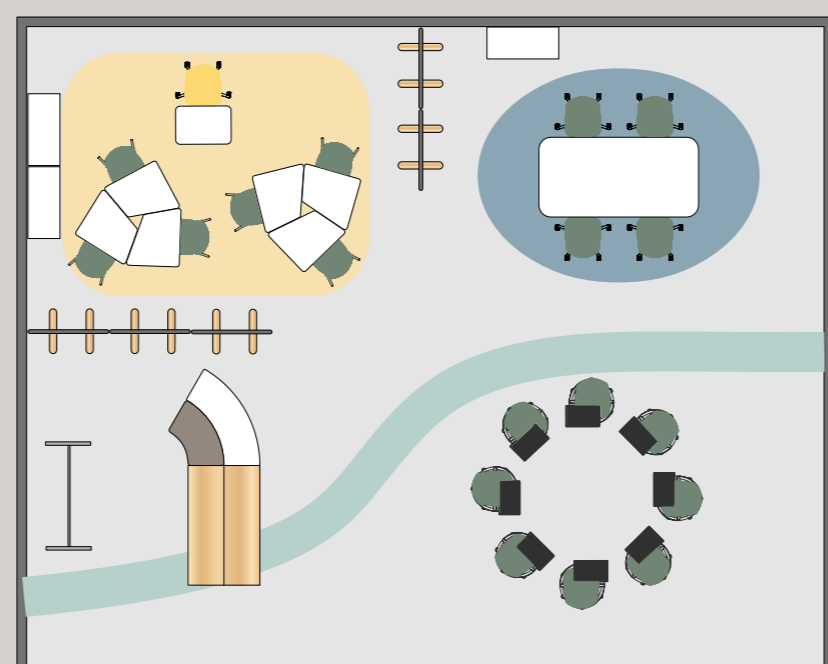
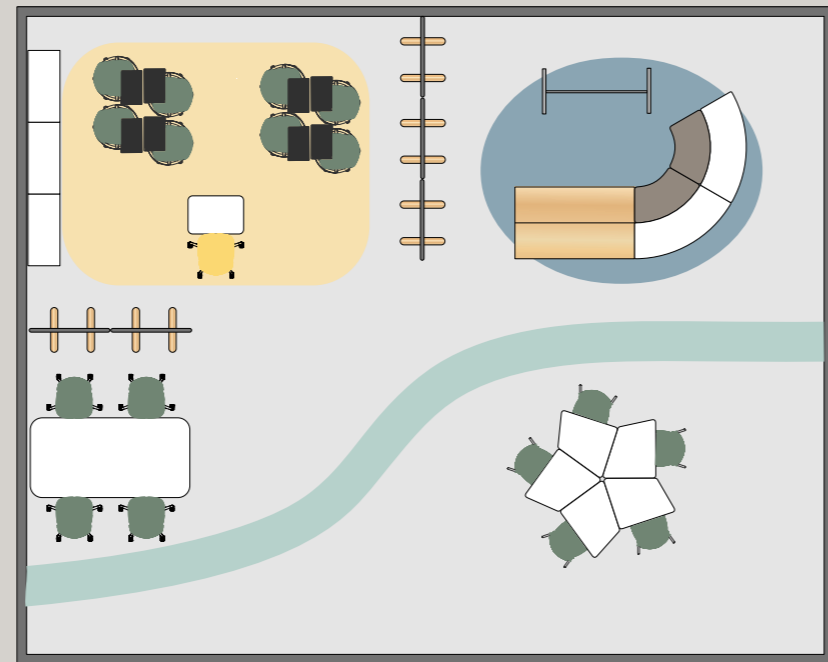





## Aula del futuro 100m2

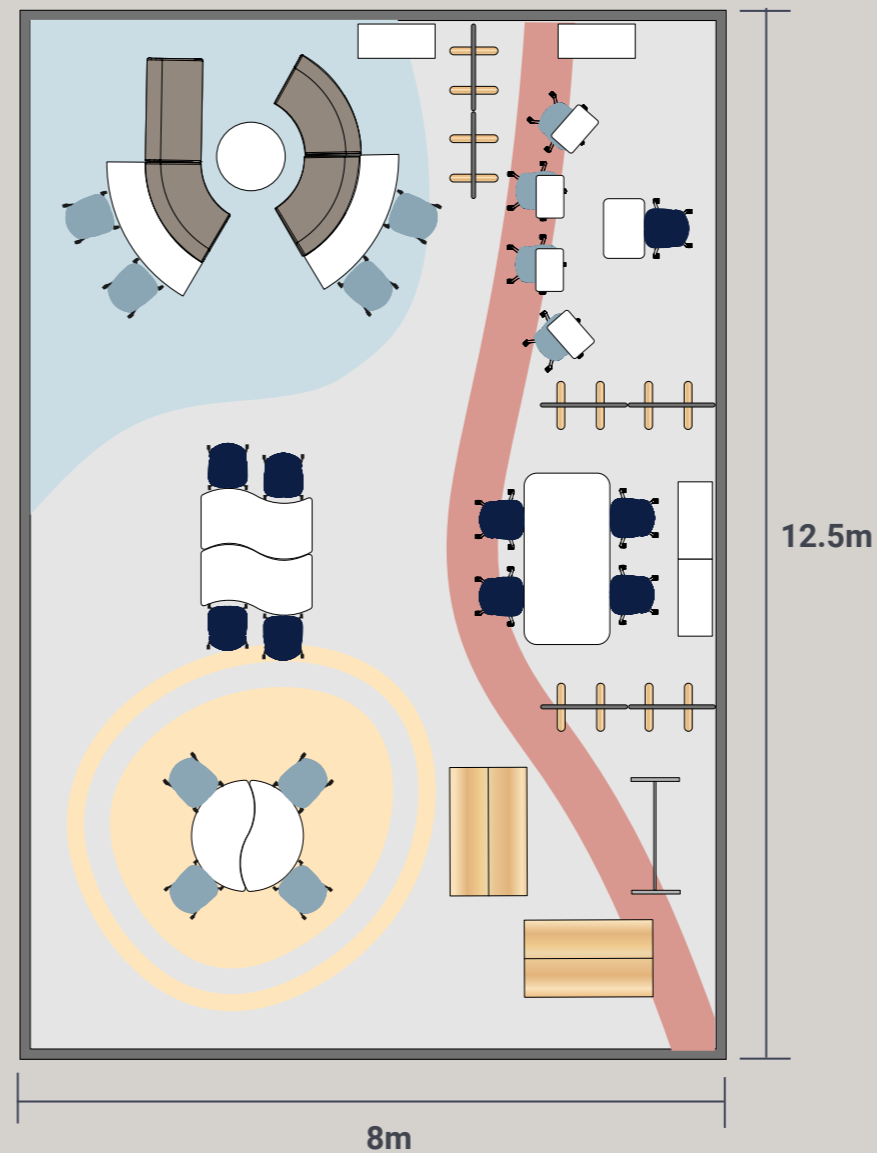

### Zona Investigación



### Zona Interacción



### Zona Intercambio



### Zona Desarrollo



### Zona Presentación





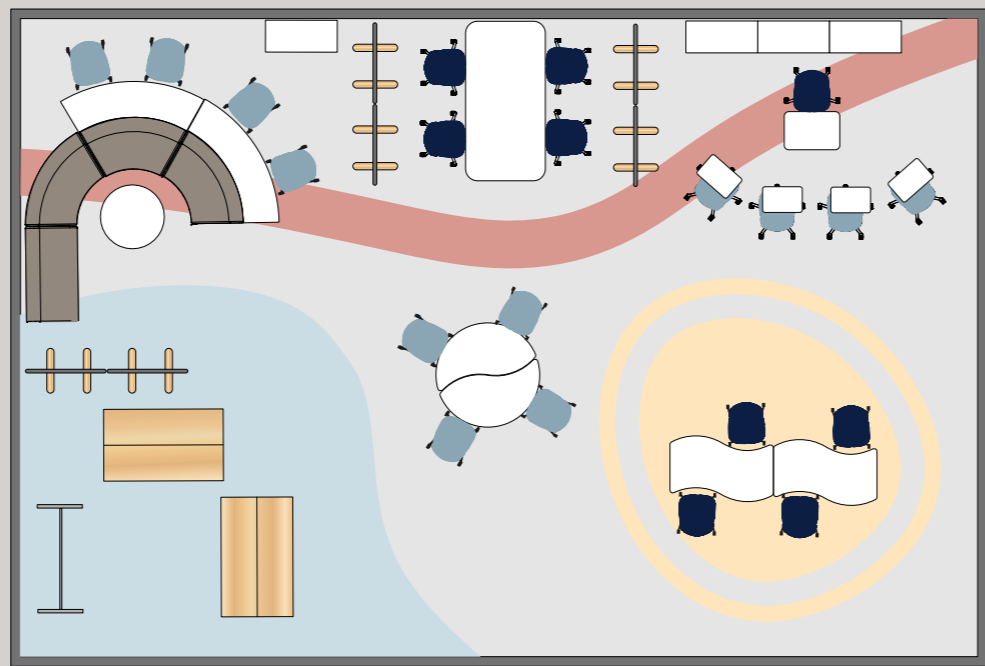
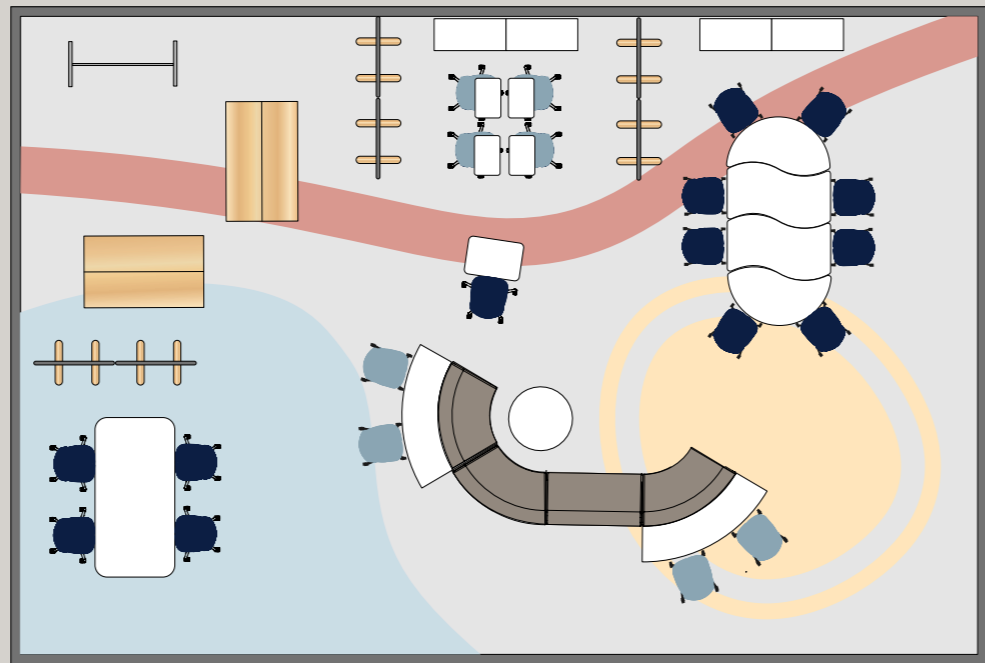





## Aula del futuro 150m2

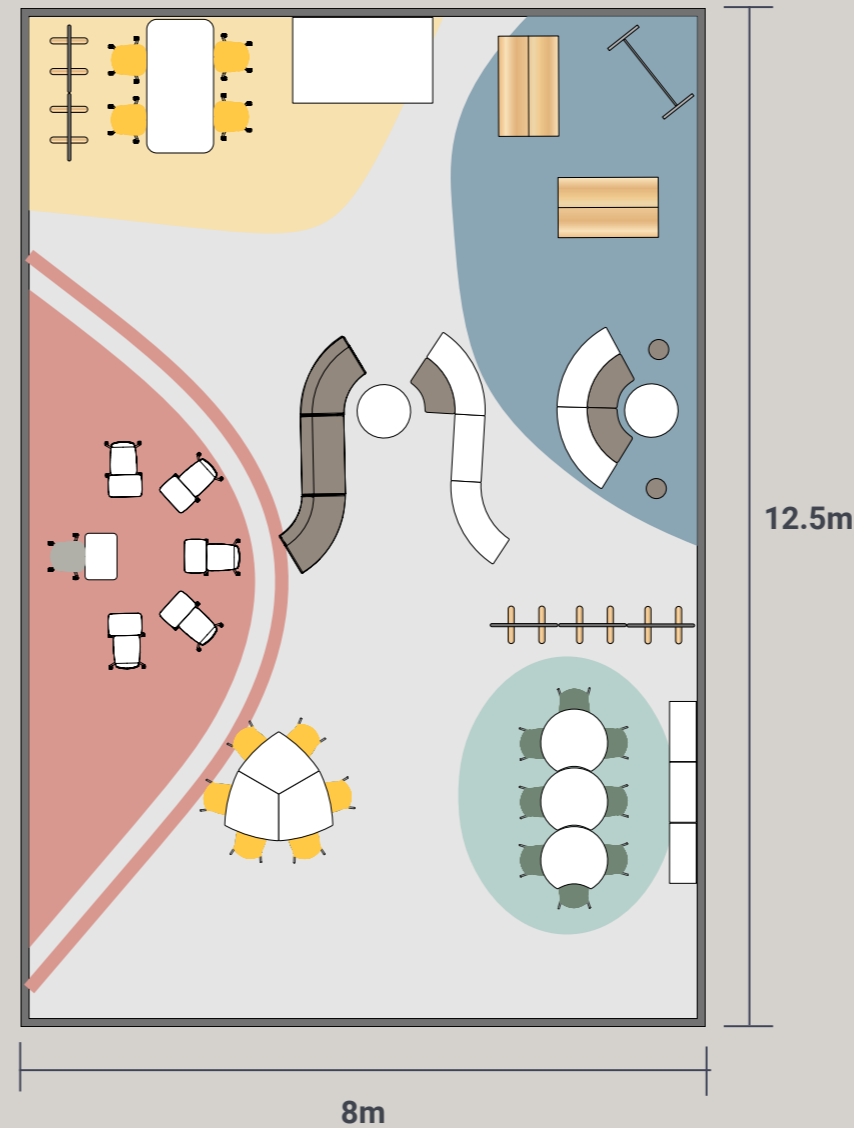

PROVEEDOR OFICIAL  
**aula del futuro**

### Zona Investigación



Silla DIDA SAC500      Mesa diamond MAC152      Mesa mopac MAC158      Armario gavetero ASN306

### Zona Intercambio



Mesa tutor MPA100      Taburete DIDA TAC580      Pad chair SAC360      Grada GAC100

### Zona Presentación



Grada GAC100

### Zona Desarrollo



Serp recto SRE200      Serp curvo C SCC200      Serp curvo A SCA200      Armario curvo AAC110

### Zona Interacción



Armario recto bajo AAC105      Softseating curvo BAC110      Taburete DIDA TAC580      Mesa alta MCA200



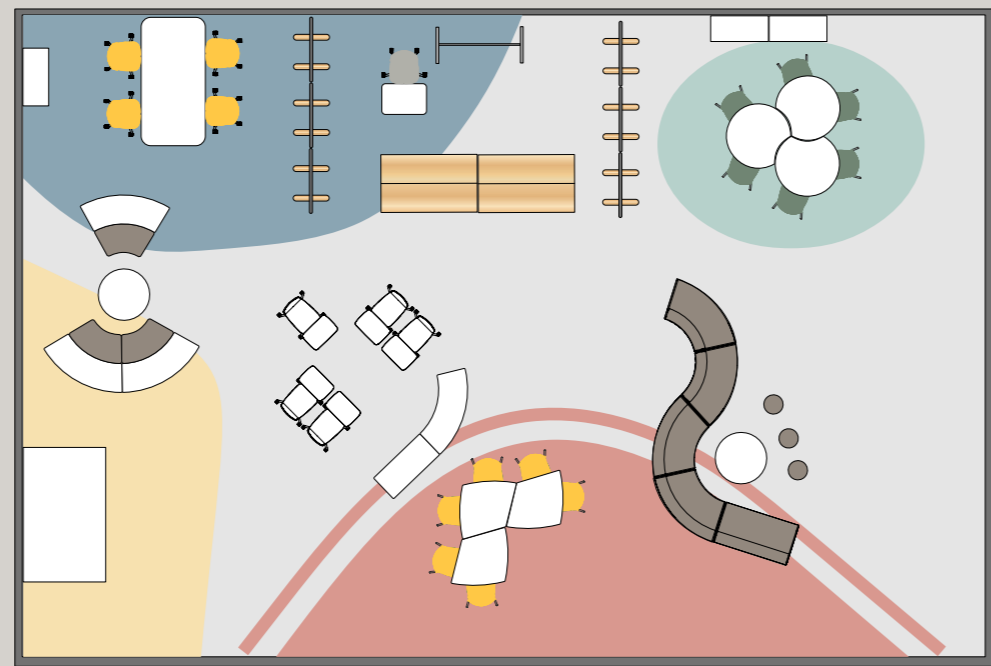
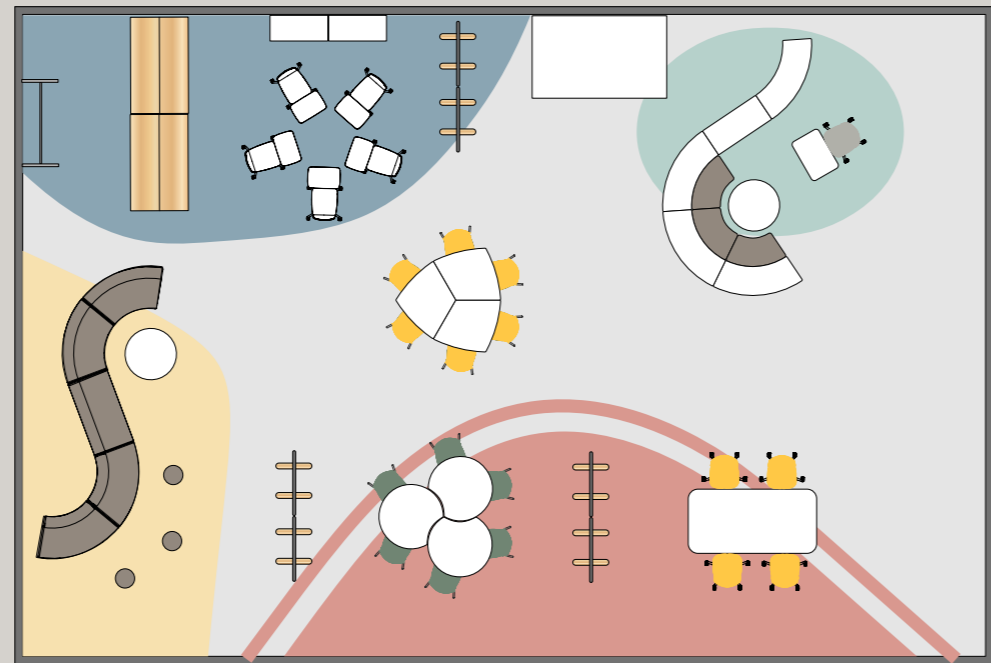



## Aula tradicional 45m2

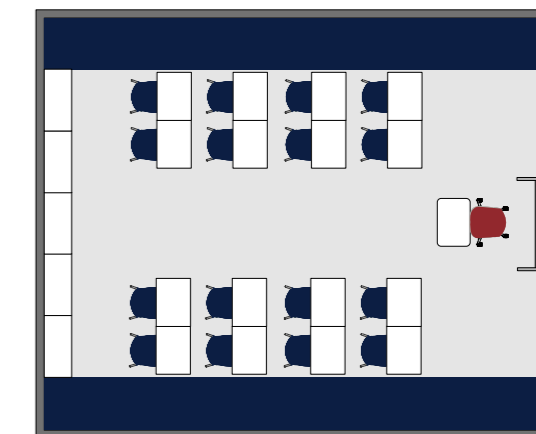

**Mesa Tutor**  
MPA100



**Taburete DIDA**  
TAC580



**Pupitre FG**  
MFG63X



**Silla DIDA**  
SAC500



**Armario con puertas**  
ASN307



**Armario gavetero**  
ASN306



**Armario con estantes**  
ASN301



**Pizarra móvil**  
PRH100



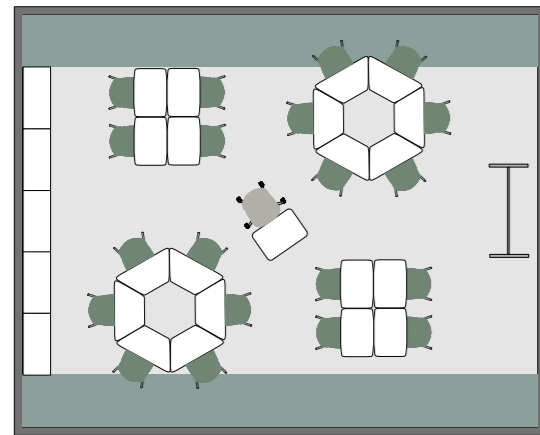

Mesa Tutor  
MPA100



Taburete DIDA  
TAC580



Pupitre trapezoidal  
MAF105



Pupitre rectangular  
MAF110



Silla DIDA  
SAC500



Armario Gavetero  
ASN306



Armario con estantes  
ASN301



Armario con puertas  
ASN307





Pizarra móvil  
PRH100



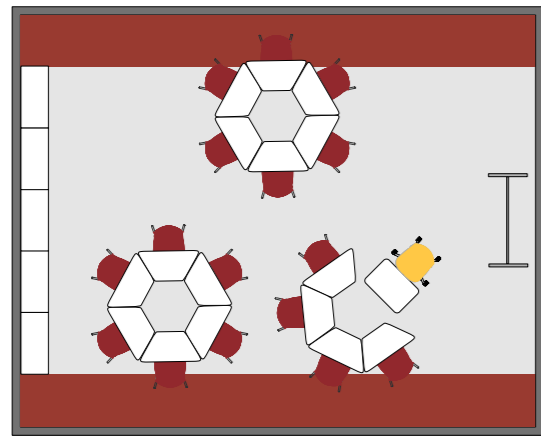









-   
**Mesa Tutor**  
MPA100

  
**Taburete DIDA**  
TAC580

  
**Pupitre Trapezoidal**  
SAC360
-   
**Silla DIDA**  
SAC500

  
**Armario con puertas**  
ASN307

  
**Armario Gavetero**  
ASN306
-   
**Armario Recto**  
AAC105

  
**Pizarra móvil**  
PRH100





# Aula infantil

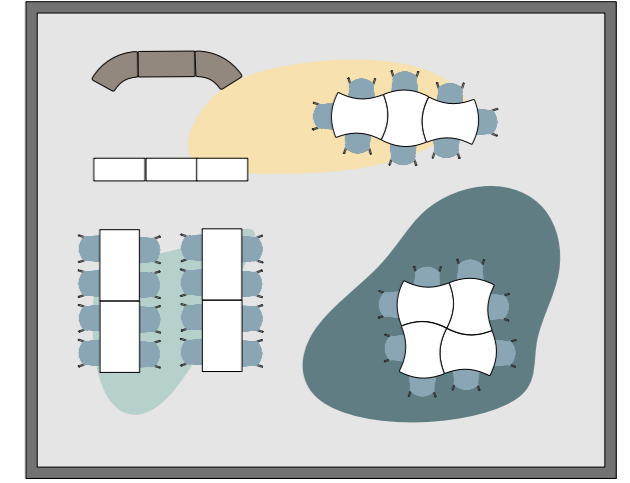

**Armario gavetero**  
ASM06



**Armario con estantes**  
ASM201



**Softseating curvo bajo**  
BAC115



**Softseating recto bajo**  
BAC105



**Silla DIDA**  
SAC500



**Mesa loop**  
MAC153



**Mesa ágil**  
MPM86X









## Biblioteca



**Silla DIDA**  
SAC500



**Mesa Diamond**  
MAC152



**Mesa Mopac**  
MAC158



**Armario Gavetero**  
AS2306



**Mesa Tutor**  
MPA100



**Taburete DIDA**  
TAC580



**Armario Alto**  
ASA501



**Grada**  
GAC100

### Zona Desarrollo



**Serp Recto**  
SRE200



**Serp Curvo C**  
SCC200



**Serp Curvo A**  
SCA200



**Armario Curvo**  
AAC110



**Armario Recto**  
AAC105



**Softseating curvo**  
BAC110



**Taburete DIDA**  
TAC580



**Mesa alta**  
MCA200



# Comedor



40



Silla DIDA  
SAC500



Mesa ágil  
MPM86X



Mesa rectangular alta  
MCA120 / MCA160





# 03

P	T	B	A	B	O	P	V	L	C	O	E	L	O
C	Y	O	B	A	Ñ	C	K	W	B	A	Q	E	A
Q	C	Ñ	A	Ñ	W	Q	C	D	R	K	<b>P</b>	Z	K
R	N	R	S	B	P	K	C	I	R	S	<b>R</b>	K	Y
Y	X	A	S	A	B	Y	M	O	P	R	<b>O</b>	O	R
C	U	V	P	X	W	C	T	P	Y	A	<b>D</b>	E	A
L	Ñ	Q	A	Z	B	L	Ñ	V	U	I	<b>U</b>	M	I
C	P	P	C	T	L	C	L	N	Z	Ñ	<b>C</b>	P	Ñ
C	Q	H	I	A	B	C	A	G	X	J	<b>T</b>	T	J
C	Y	G	O	B	V	C	C	H	L	K	<b>O</b>	L	K
C	L	I	S	R	Q	C	O	K	R	L	<b>S</b>	S	L
M	Y	K	R	E	Z	M	P	B	W	M	V	P	M





# Sillas



DIDA Classic  
SAC500

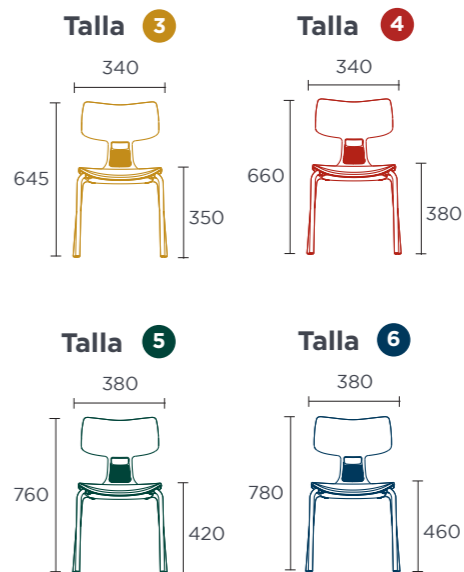

### Polipropileno



### Patas



Ver colección





### DIDA Active

Ref. SAC520



Talla 6

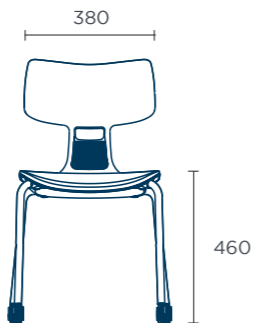

#### Polipropileno



Ash Grey



Olive Green



Powder Blue



Nordic



Valencia Yellow



Cayenne

#### Patas



9006

### DIDA Move

Ref. SAC580



Talla 6

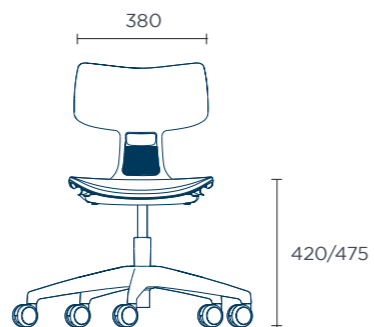

#### Polipropileno



Ash Grey



Olive Green



Powder Blue



Nordic



Valencia Yellow



Cayenne

#### Base



Negro







### DIDA Basket

Ref. SAC590



Talla 6

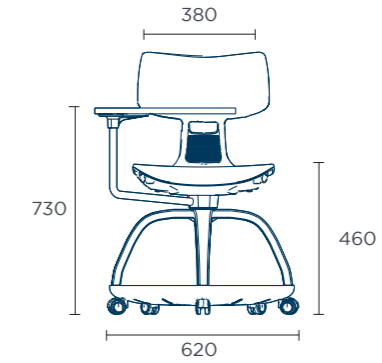

Polipropileno



Ash Grey



Olive Green



Powder Blue



Nordic



Valencia Yellow



Cayenne

Base



Negro

### DIDA Move

Ref. SAC580



Talla 6

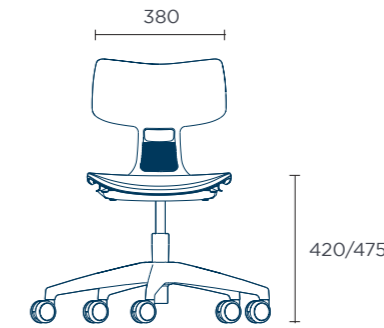

Polipropileno



Ash Grey



Olive Green



Powder Blue



Nordic



Valencia Yellow



Cayenne

Base



Negro





**Taburete DIDA**  
Ref. TAC580

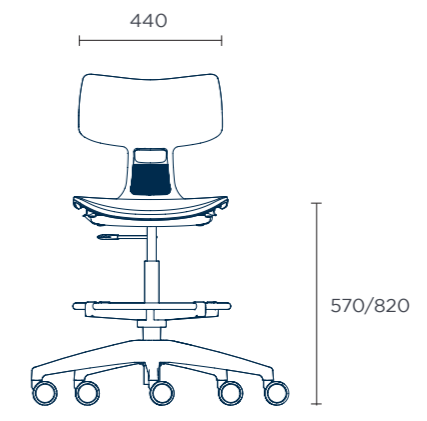

- Polipropileno**
- Ash Grey
  - Olive Green
  - Powder Blue
  - Nordic
  - Valencia Yellow
  - Cayenne
- Base**
- Negro

**Taburete DIDA con brazos**  
Ref. TAC580B

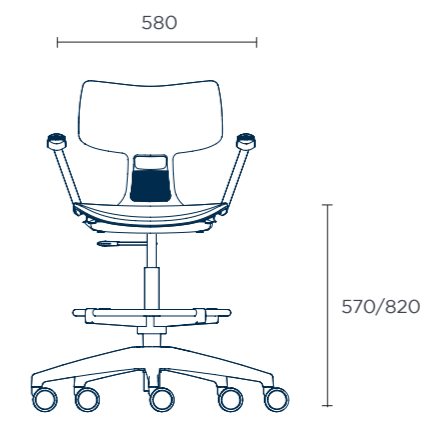
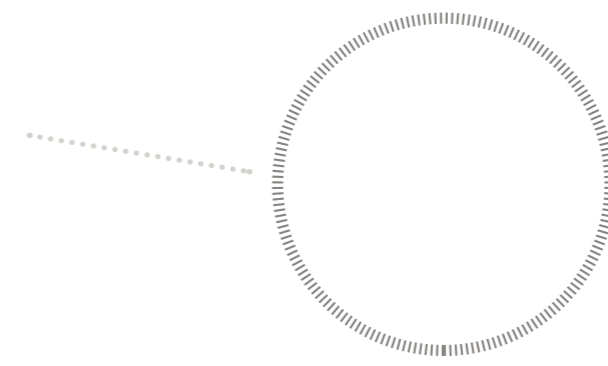

- Polipropileno**
- Ash Grey
  - Olive Green
  - Powder Blue
  - Nordic
  - Valencia Yellow
  - Cayenne
- Base**
- Negro



**Taburete Chambo**  
Ref. TAC568

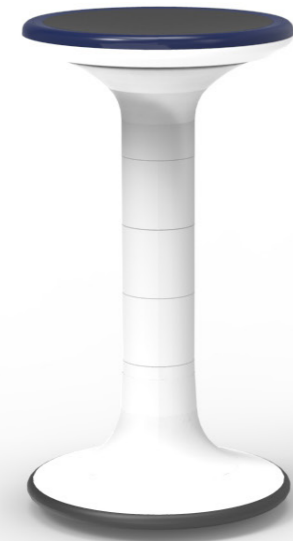

**Cuerpo**



Blanco

**Asiento**



Negro

**Talla 2**

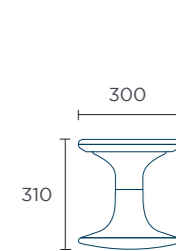

**Talla 4**

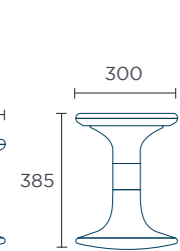

**Talla 6**

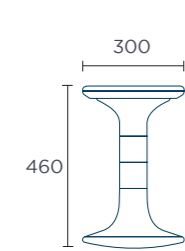

**Talla 7**

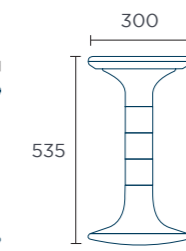

**Silla Postura +**  
Ref. SAP37x



20 Años  
de garantía

[ DISTRIBUCIÓN  
EXCLUSIVA ]

[ FABRICADA EN  
REINO UNIDO ]

**Talla 1**

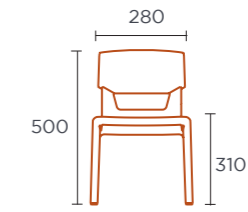

**Polipropileno**



Poppy Red



Forest Green



Sun Yellow



Ink Blue



Ash Grey



Powder Blue

**Talla 2**

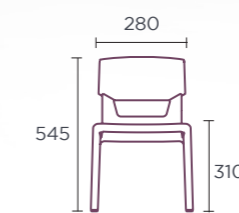

**Talla 3**

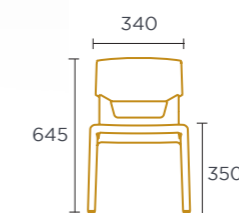

**Talla 4**

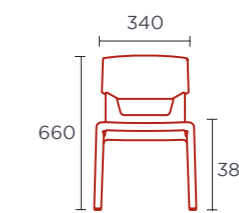

**Talla 5**

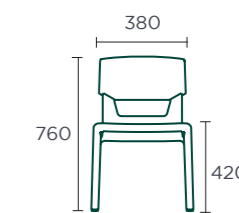

**Talla 6**

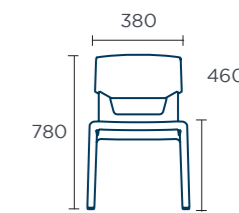

**Polipropileno**



Ink Blue



Ash Grey



Powder Blue



Olive Green



Valencia  
Yellow





**Pad Chair**  
Ref. SAC360

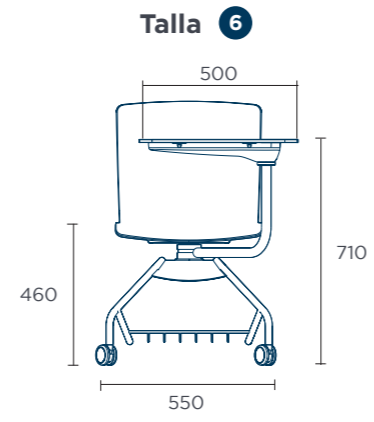

**Carcasa**



Blanco



Roble

**Base**



9006

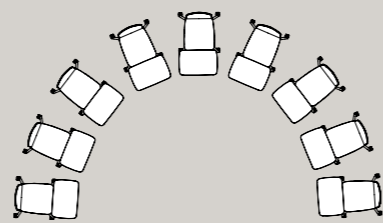
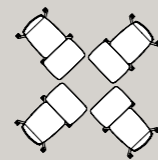
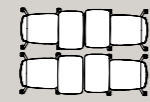
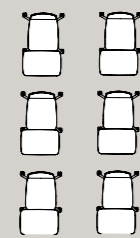
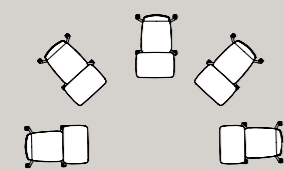



**Master Pro move**  
Ref. SOF400

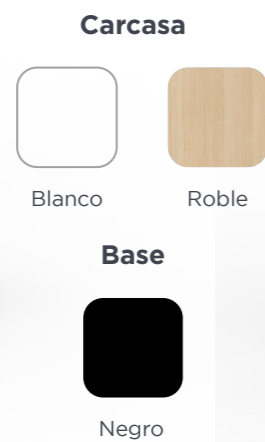

Talla 6

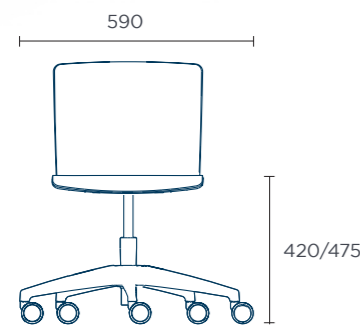

**Master Pro confort**  
Ref. SOF450



Talla 6

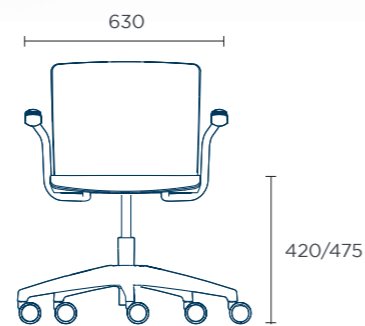

**Master Pro**  
Ref. SOF500



**Patas**



Aluminio

Talla 6

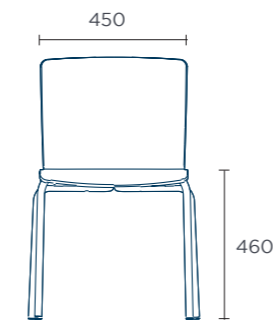



# Silla Oficina

Ref. SOF200



Talla 6

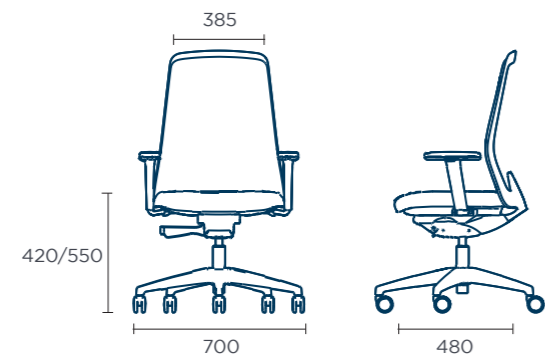

Tapizado



Negro

Base



Negro





# Mesas



## MESAS ACTIFLEX®

Mesas modulares diseñadas para las nuevas metodologías son altamente versátiles y se adaptan a las necesidades cambiantes de cualquier entorno de trabajo. Con la capacidad de regular la altura, proporcionan una ergonomía óptima para diferentes usuarios. Ya sea fija o móvil, su sistema de peana robusta garantiza estabilidad y durabilidad. Estas mesas son el complemento perfecto para potenciar la colaboración y la creatividad en cualquier espacio.

Modular tables designed for new methodologies are highly versatile and adapt to the changing needs of any work environment. With the ability to adjust the height, they provide optimal ergonomics for different users. Whether fixed or mobile, their sturdy pedestal system ensures stability and durability. These tables are the perfect complement to enhance collaboration and creativity in any space..



Ver colección



Sistema de sujeción patentado

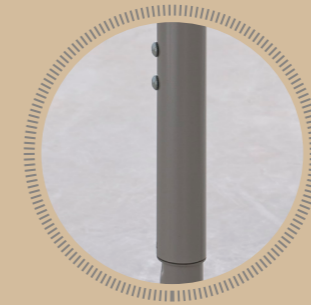

Sistema de regulación de altura



Opción pata fija



Opción móvil

## Modelos



Loop



Diamond



Mopac



Ola



Yang



**Mesa Loop**  
Ref. MAC153



**Superficie**



Blanco

**Patas**



9006

**Tablero**

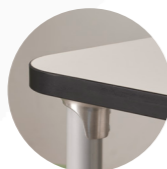

Basic



Premium

**Mesa Diamond**  
Ref. MAC152



62

63

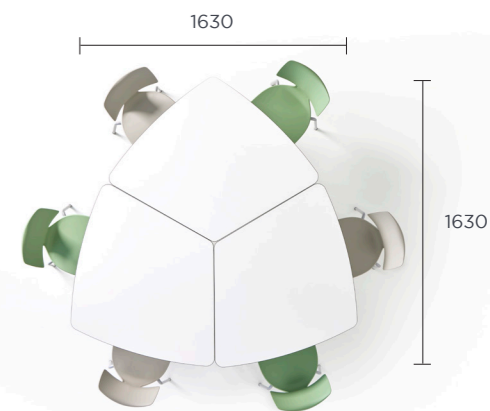
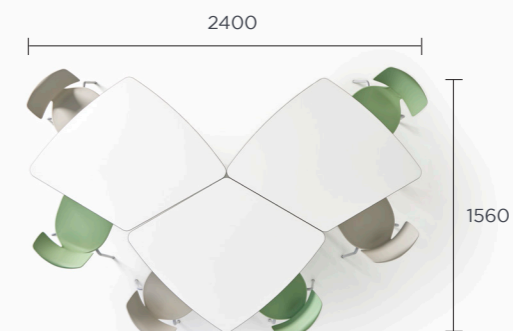
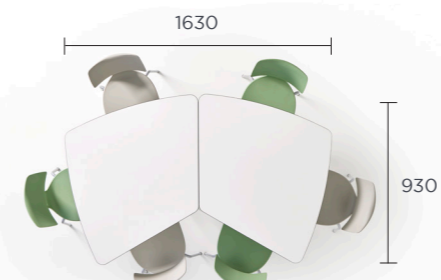
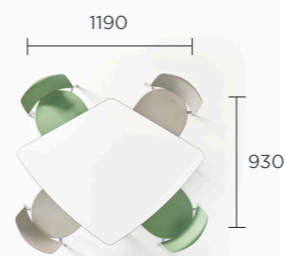
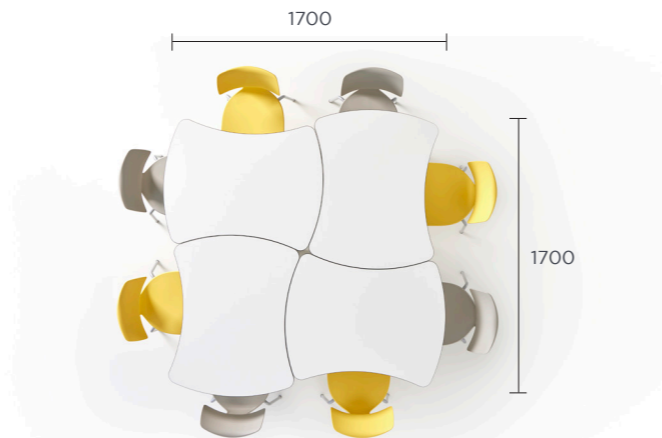
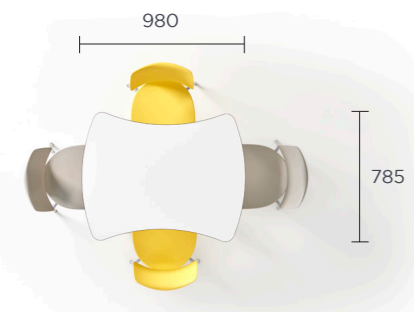



**Mesa Yang**  
Ref. MAC162

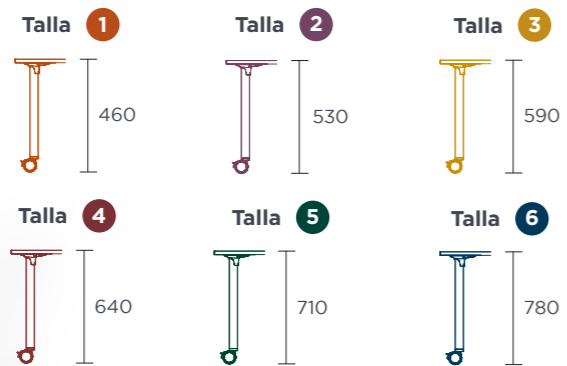

**Superficie**



Blanco

**Patas**



Aluminio

**Tablero**



Basic

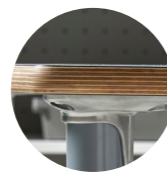

Premium

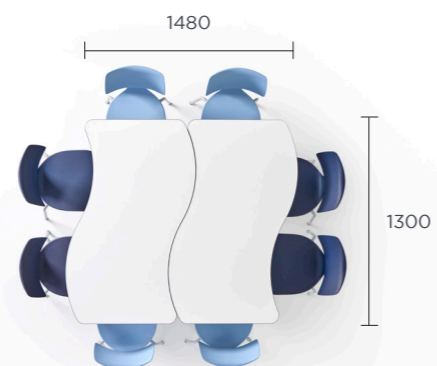
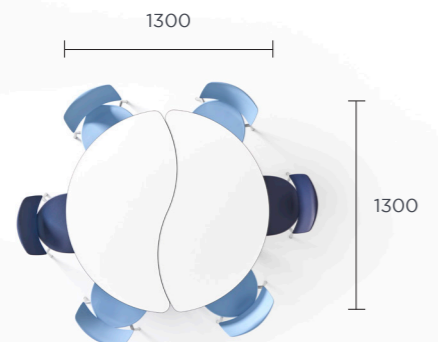
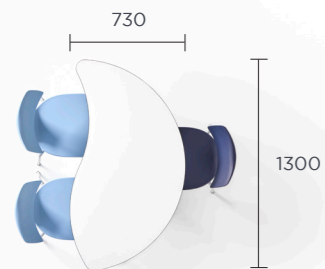

**Mesa Wave**  
Ref. MAC161

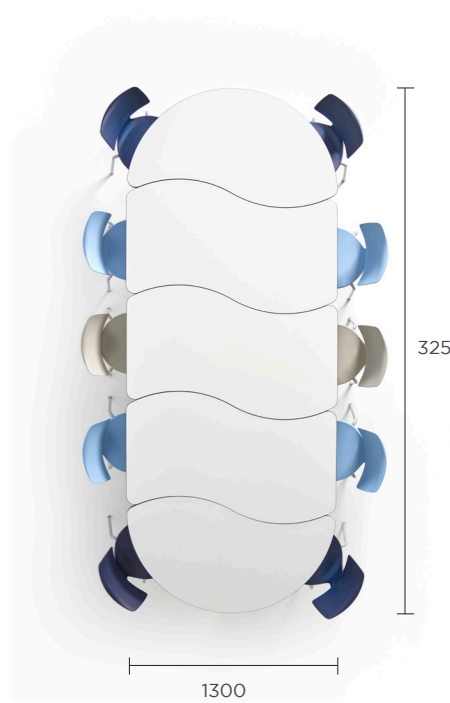
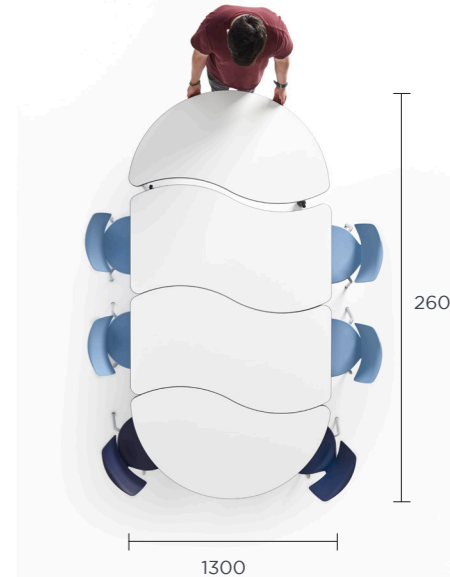



**Mesa Mopac**  
Ref. MAC158

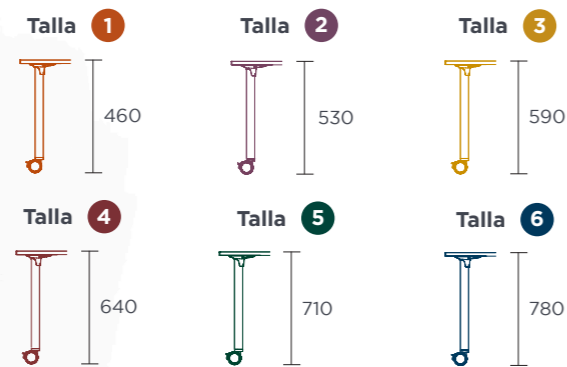

**Superficie**



Blanco

**Patas**



Aluminio

**Tablero**



Basic

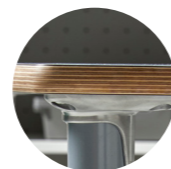

Premium

66

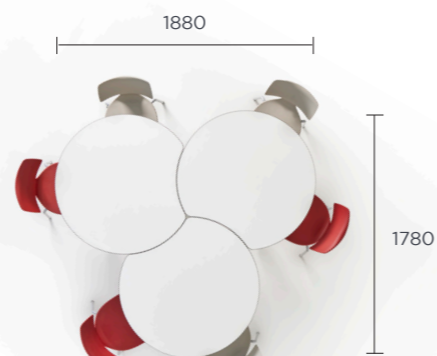
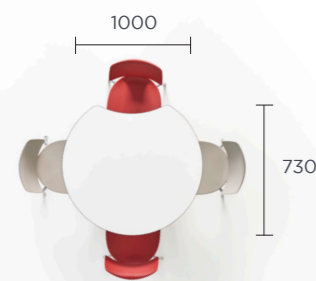





**Mesa Tutor**  
Ref. MPA100

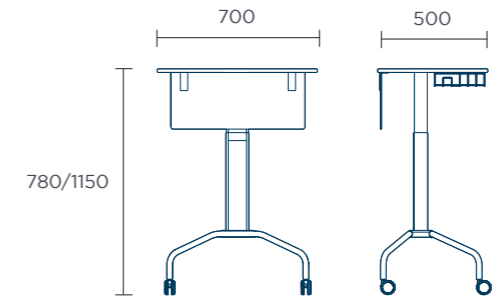

**Superficie**



Blanco

**Patas**



Aluminio

**Tablero**



Basic

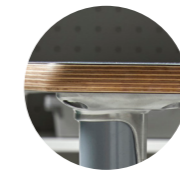

Premium

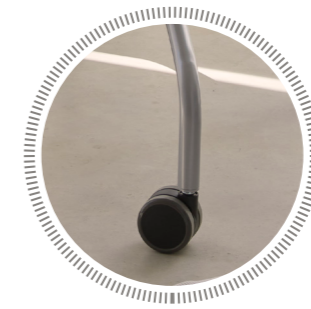





## Mesa Modular

Ref. MM076x



### Superficie



Blanco

### Patas



Aluminio

### Tablero



Basic



Premium

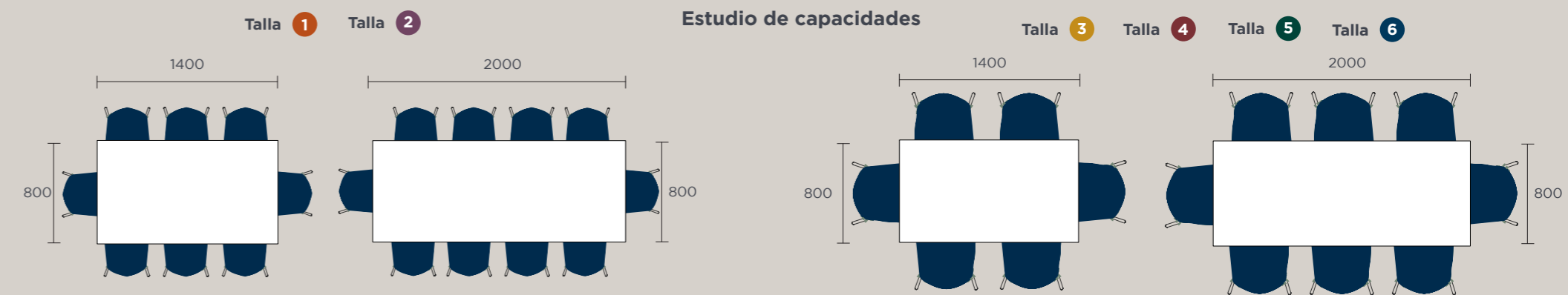
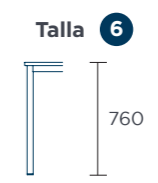
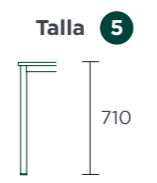
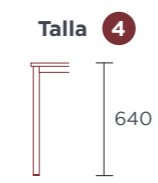
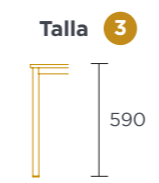
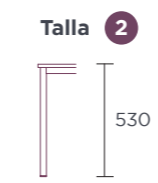
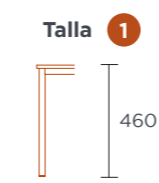



# Mesa Ágil

Ref. MPM86x



## Tallas

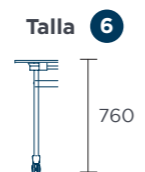
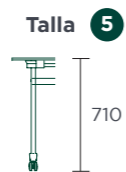
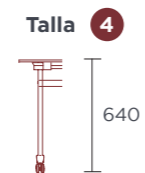
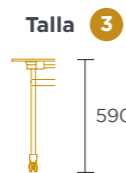

## Superficie



Blanco

## Patas



Aluminio

## Tablero



Basic

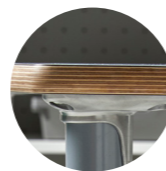

Premium

1400/2000



## Estudio de capacidades

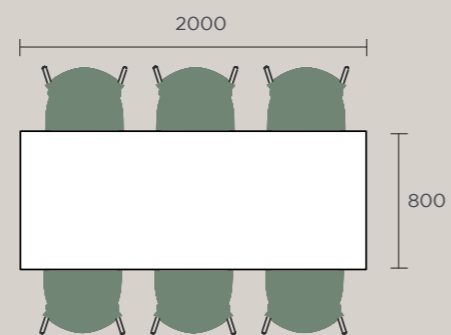
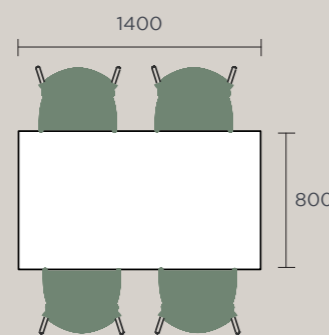



# Pupitres



## Pupitre rectangular Actiflex

Ref. MAF110

Talla 1

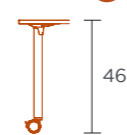

460

Talla 2

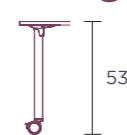

530

Talla 3

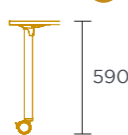

590

Talla 4

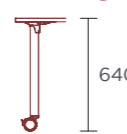

640

Talla 5

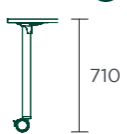

710

Talla 6

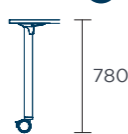

780

Superficie



Blanco

Patas



Aluminio

Tablero



Basic



Premium

## Pupitre trapezoidal Actiflex

Ref. MAF105



75

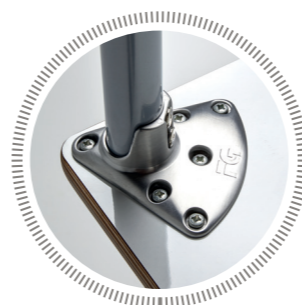

Sistema de sujeción patentado

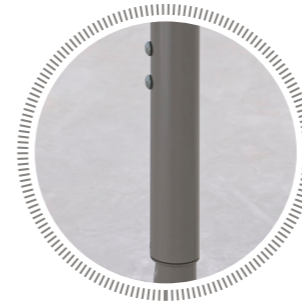

Sistema de regulación de altura

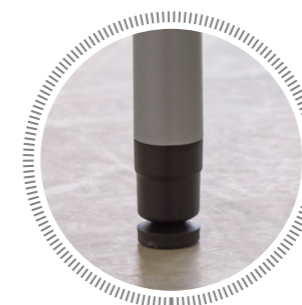

Opción pata fija



Opción móvil



Opción gaveta

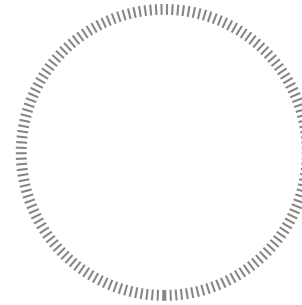

Opción rejilla



# Pupitre poligon

Ref. MAF345

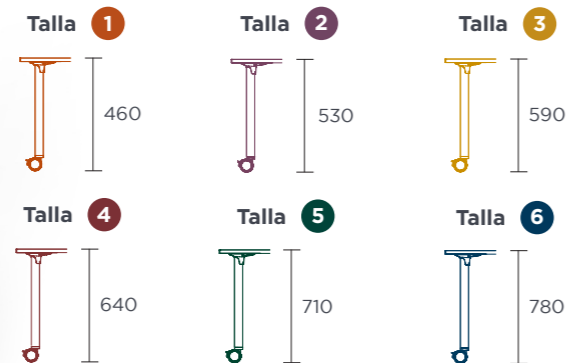

<b>Superficie</b>	<b>Patas</b>
Blanco	Aluminio
<b>Tablero</b>	
Basic	Premium

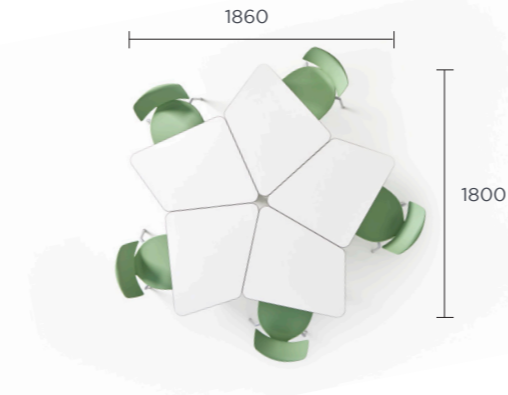
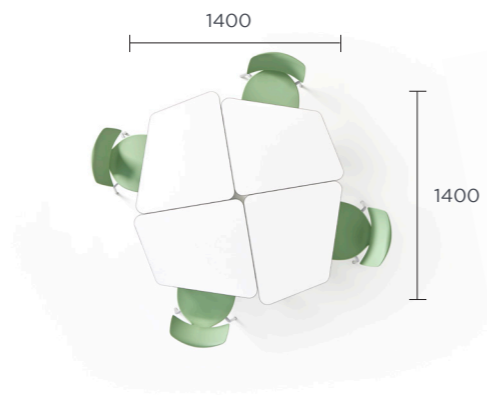
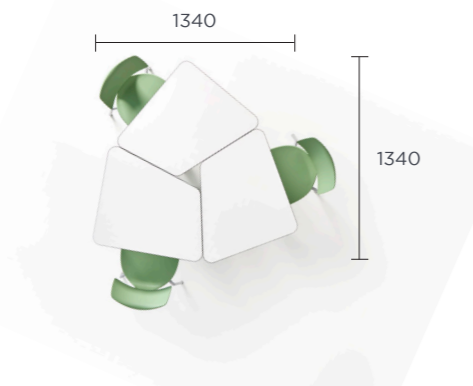
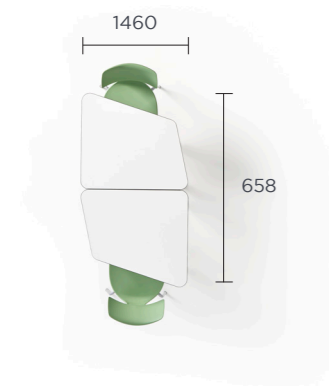



**Pupitre rectangular**  
Ref. MAC110

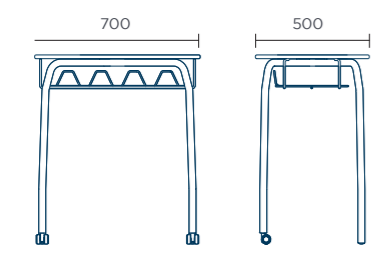
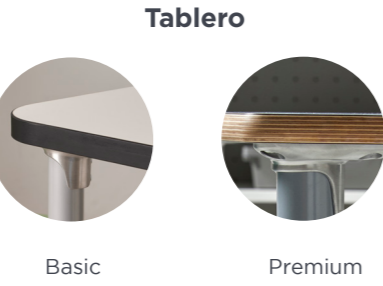

**Pupitre trapezoidal**  
Ref. MAC105



Rejilla opcional

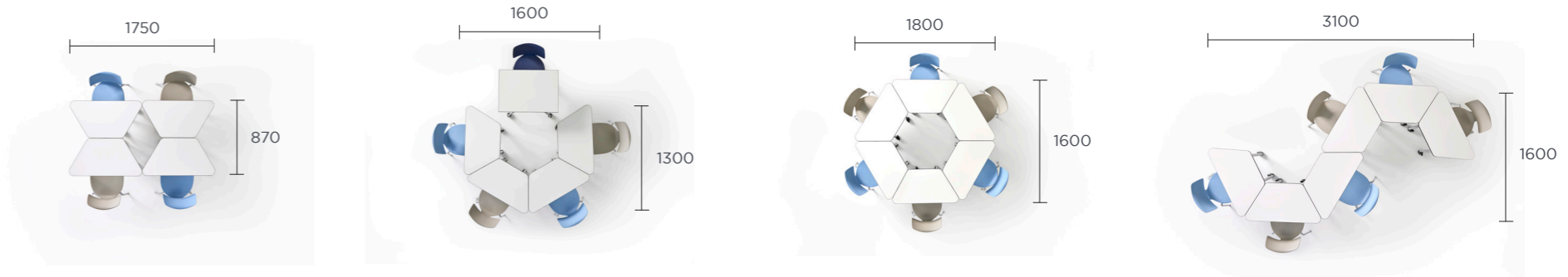
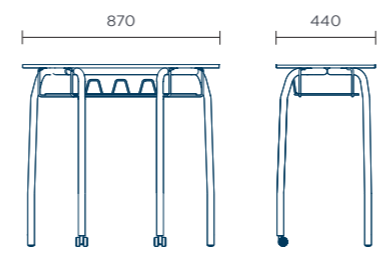



**Pupitre FG**  
Ref. MFG60X

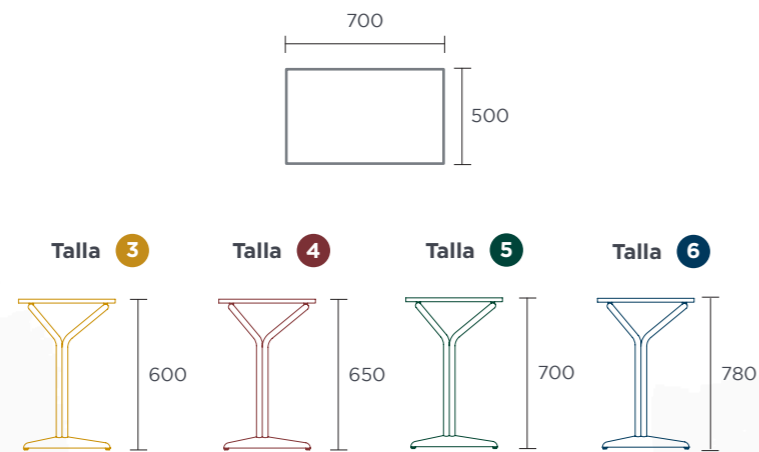

**Tablero**



Blanco

**Patas**



Aluminio

**Tablero**



Basic

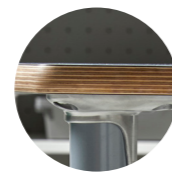

Premium

**Pupitre FG estante de madera**  
Ref. MFG61X



**Pupitre FG estante de rejilla**  
Ref. MFG630







## ACTIFLEX® Wave

La colección Actiflex Wave es una apuesta por el diseño y la innovación. Compuesta de gradas, softseatings de tapizados variados y armarios móviles de diferentes alturas. Esta colección se ha concebido para crear espacios únicos y especiales donde disfrutar, a partes iguales, del trabajo y del descanso.

Actiflex Wave collection is a commitment to design and innovation. It is composed of bleachers, softseatings with varied upholstery and mobile cabinets of different heights. This collection has been conceived to create unique and special spaces where to enjoy, in equal parts, work and rest.



Ver colección

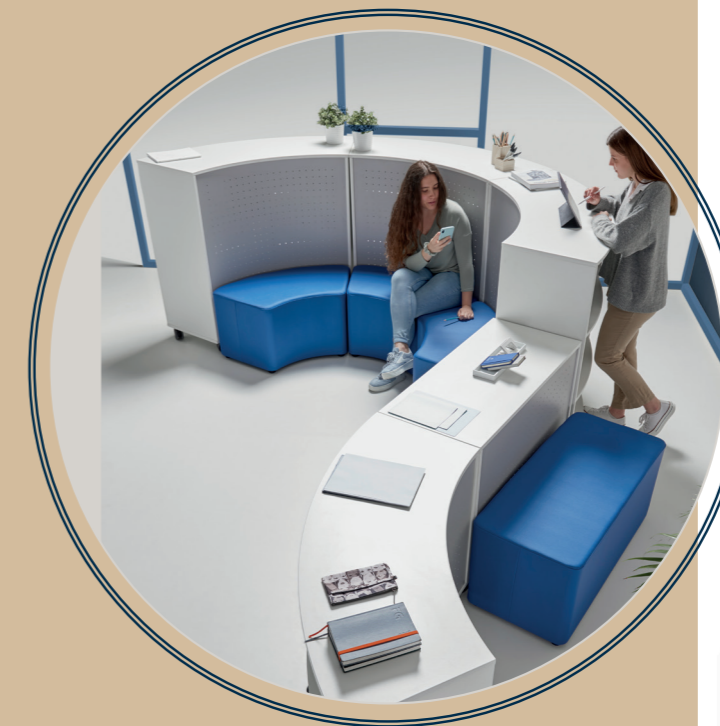

### Modelos



Armario recto bajo



Armario recto



Armario curvo bajo



Armario curvo



Softseating recto bajo



Softseating recto



Softseating curvo bajo



Softseating curvo



Grada



**Armario recto bajo**  
Ref. AAC105

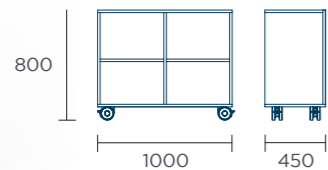
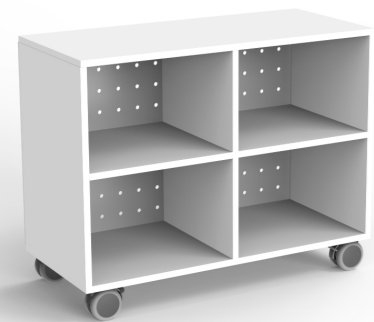

**Cuerpo**



Blanco

**Trasera**



Aluminio

**Armario recto alto**  
Ref. AAC100

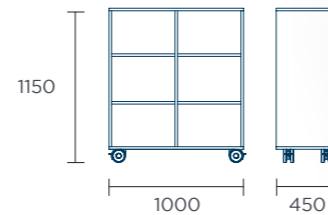

**Armario curvo bajo**  
Ref. AAC115

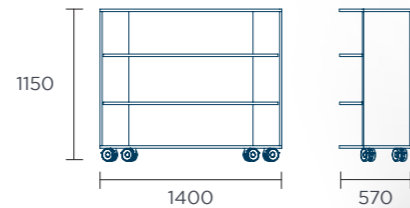
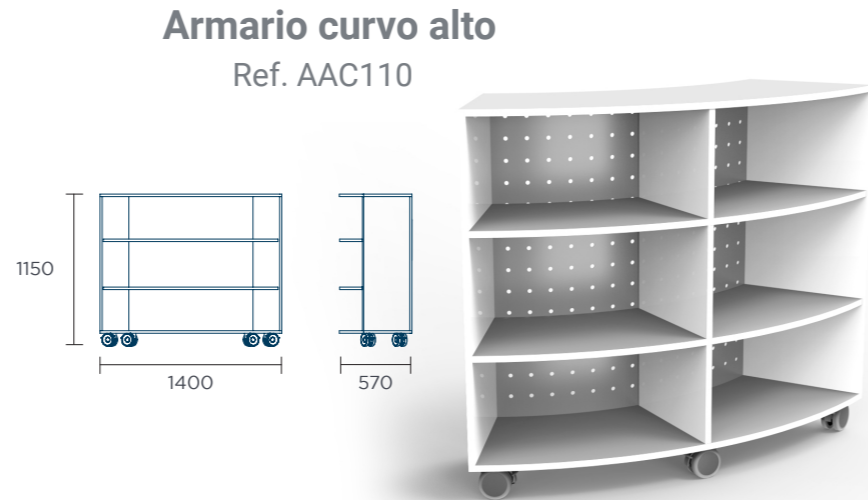
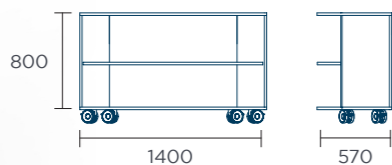
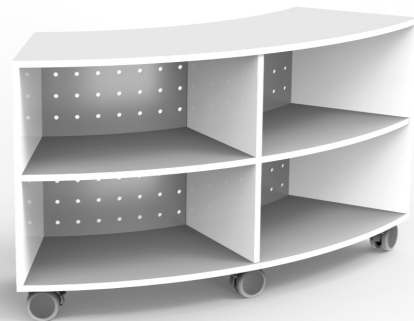

**Softseating recto bajo**  
Ref. BAC105

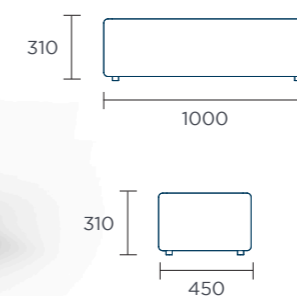

**Tela**



Baltic



Macadamia



Forest

**Softseating recto alto**  
Ref. BAC100

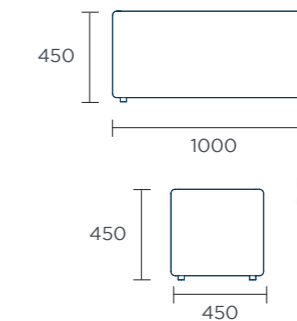

**Softseating curvo bajo**  
Ref. BAC105

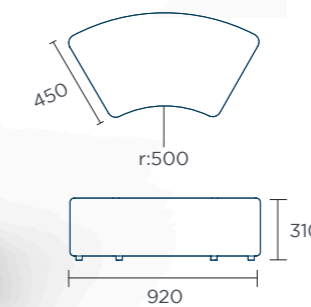

**Softseating curvo alto**  
Ref. BAC110

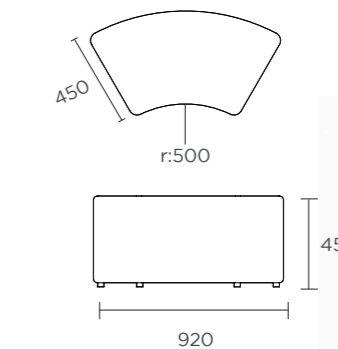



**GRADA**  
Ref. GAC100



**Cuerpo**



Blanco

**Asiento**



Roble

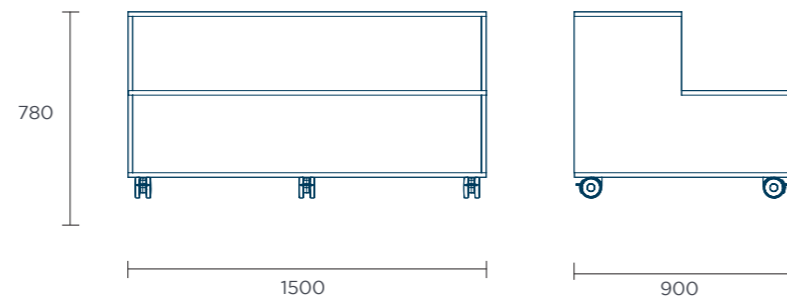

86

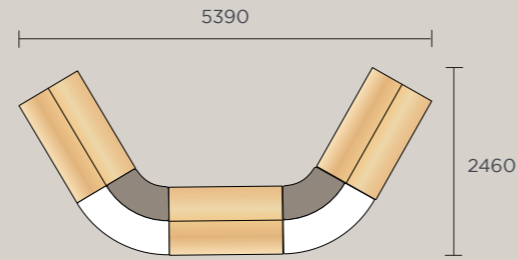
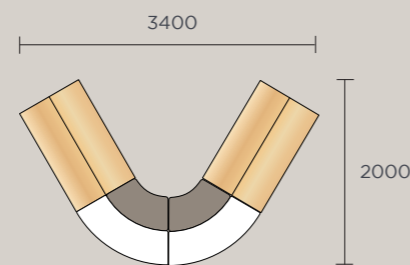
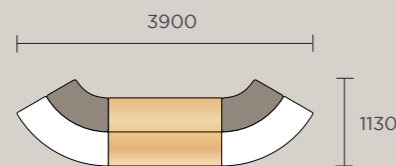
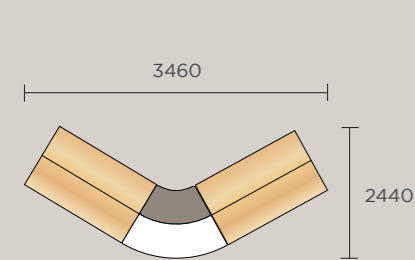



# Armarios



## Estantería baja

Ref. ASM201



Cuerpo



Blanco

## Estantería baja con gavetas

Ref. ASM206



Cuerpo



Blanco

Gavetas



Powder blue



Ash grey



Olive green



Valenica Yellow

## Armario bajo con puertas

Ref. ASM208

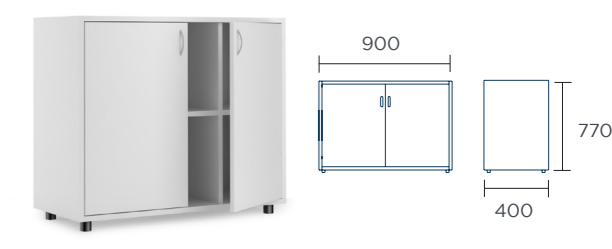

Cuerpo



Blanco

## Estantería

Ref. ASN301



Cuerpo



Blanco

## Estantería con gavetas

Ref. ASN306



Cuerpo



Blanco

Gavetas



Powder blue



Ash grey



Olive green



Valenica Yellow

## Armario con puertas

Ref. ASN307



Cuerpo



Blanco





**Estantería**  
Ref. ASA401

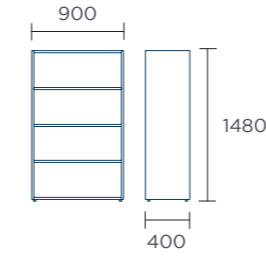

**Cuerpo**  
Blanco

**Estantería con gavetas**  
Ref. ASA404

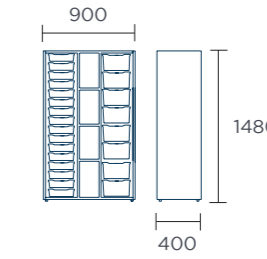

**Cuerpo**  
Blanco

**Gavetas**

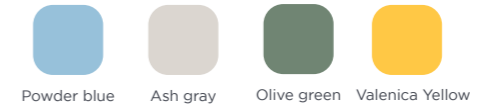

**Armario con puertas**  
Ref. ASA405

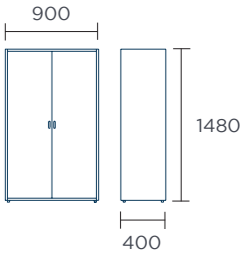

**Cuerpo**  
Blanco

**Armario con puertas y estantes**  
Ref. ASA407

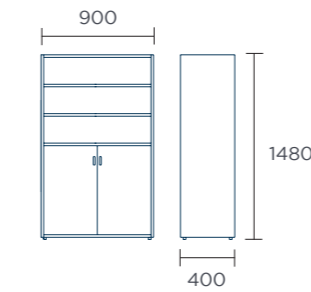

**Cuerpo**  
Blanco

**Estantería**  
Ref. ASA501

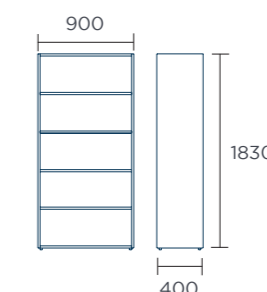

**Cuerpo**  
Blanco

**Armario con puertas**  
Ref. ASA502

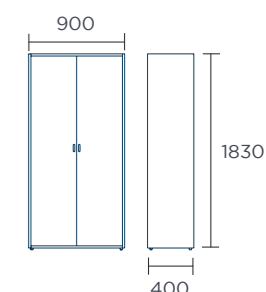

**Cuerpo**  
Blanco





# 04

P T B A B O P V L C O E L O  
 C Y O B A Ñ C K W B A Q E A  
 Q C Ñ A Ñ W Q C D R K P Z K  
 R N G S B P K C I R S R K Y  
 Y X W S A B Y M O P R O O R  
 C U P P X W C T P Y A D E A  
 L Ñ L A Z B L Ñ V U I U M I  
 C P R C T L C L N Z Ñ C P Ñ  
 C Q H I A B C A G X J T T J  
**G U I A D E T A L L A S** L K  
 C L I S R Q C O K R L S S L  
 M Y K R E Z M P B W M V P M

04 Size Guide

## GUÍA DE TALLAS

\*Todas las medidas se consideran en mm.  
\*Independientemente de las medidas de esta guía, cada producto tiene sus medidas específicas en su ficha comercial informativa.











SEGÚN LA NORMATIVA UNE-EN 1729 SILLAS Y MESAS PARA CENTROS DE ENSEÑANZA.

### Normativa.

En **FEDERICO GINER** nos tomamos muy en serio la seguridad de nuestros diseños. Por eso, seguimos la norma **española y europea UNE-EN 1729** para centros de enseñanza, donde se regulan las dimensiones funcionales y los requisitos de seguridad del mobiliario escolar, en su primera y segunda parte.

Esta normativa codifica cada talla con un color y un número. Las tallas 0 y 1 son claramente tallas para centros infantiles de primera etapa (*escuelas infantiles*). El resto de tallas son las que se usan para el resto de etapas educativas.

Las medidas más importantes para determinar las tallas, son la altura total de los alumnos y el rango poplíteo. Estos se han determinado en base a estudios antropométricos y ergonómicos, siendo las medidas marcadas en la norma las más adecuadas para la adopción de una buena postura del alumno, y su menor fatiga durante el uso.

						
	<b>TALLA 1</b>	<b>TALLA 2</b>	<b>TALLA 3</b>	<b>TALLA 4</b>	<b>TALLA 5</b>	<b>TALLA 6</b>
Orientativo	INFANTIL	INFANTIL	PRIMARIA 1º-2º	PRIMARIA 3º-4º	PRIMARIA 5º-6º	SECUNDARIA
	0 - 3 años	3 - 5 años	5 - 6 años	6 - 9 años	9 - 11 años	+ de 11 años
	930 - 1160	1080 - 1210	1190 - 1420	1330 - 1590	1460 - 1765	1590 - 1880
	250 - 280	280 - 315	315 - 355	355 - 405	405 - 435	435 - 485
 ± 10	260	310	350	380	430	460
 ± 20	460	530	590	640	710	760





# 05

P T B A B O P V L C O E L O  
 C Y O B A Ñ C K W B A Q E A  
 Q C Ñ A Ñ W Q C D R K P Z K  
 R N **A** S B P K C I R S R K Y  
 Y X O **C** A B Y M O P R O O R  
 C U M P **A** W C T P Y A D E A  
 L Ñ B A Z **B** L Ñ V U I U M I  
 C P I C T L **A** L N Z Ñ C P Ñ  
 C Q H I A B C **D** G X J T T J  
 G U I A D E T A **O** L A S L K  
 C L I S R Q C O K **S** L S S L  
 M Y K R E Z M P B W M V P M

## ACABADOS / FINISHES

### Estructura metálica / Metal structure

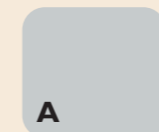

Aluminium

### Colección DIDA / DIDA collection

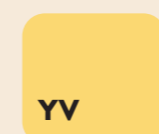

Valencia Yellow



Green Olive

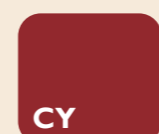

Cayenne

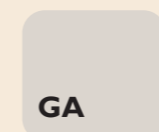

Ash Grey

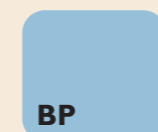

Powder Blue

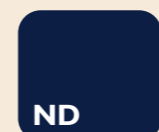

Nordic

### Gavetas (Polipropileno) / Drawers

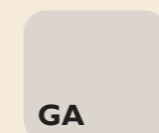

Ash Grey

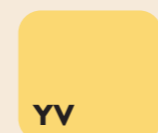

Valencia Yellow



Green Olive

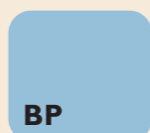

Powder Blue

### Tapas de mesas y pupitres / Tables and desks tops

#### Basic



Melamina

La melamina es un material utilizado en la fabricación de muebles y superficies. Esta melamina en particular tiene un espesor de 25mm y cuenta con un canto de PVC encolado con pegamento sostenible.

Melamine is a material used in the manufacture of furniture and surfaces. This particular melamine is 25mm thick and has a PVC edge glued with sustainable glue.

#### Premium



Contrachapado

Compuesto por diferentes chapas de madera de haya y/o abedul encoladas y prensadas, en diferentes fases. La superficie de HPL es de 1 mm de espesor.

Composed of different glued and pressed beech and/or birch veneers, in different phases. The HPL surface is 1mm thick.



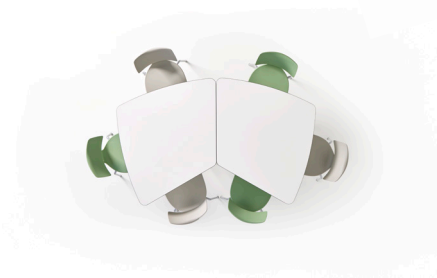
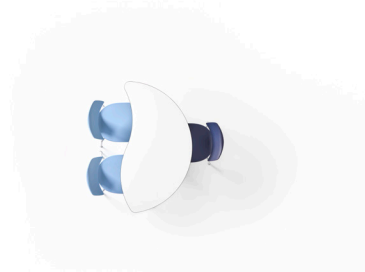
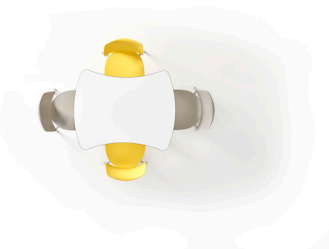
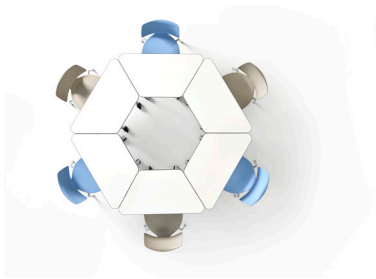

C/ Portalet esquina Ctra. Liria-Tavernes  
46760. Tavernes de la Valldigna. Valencia

T. 96 282 40 50

M. 608 218 939

[info@federicoginer.com](mailto:info@federicoginer.com)

[www.federicoginer.com](http://www.federicoginer.com)

