

THE SOLU- TION

CATÁLOGO
GENERAL
MOBILIARIO

Vers. 1.0



Grupo Ismobel

Somos muchos
y muy diferentes,
**pero nuestra
singularidad
es la diversidad.**

Una diversidad de países, culturas, costumbres,
personas, que están obligadas a coexistir.

Dentro de las empresas existen diferentes, áreas, perfiles,
equipos, proyectos y objetivos.
Cada uno con sus necesidades concretas.

Te proponemos un
viaje por la diversidad
**por un mundo
de posibilidades.**

WE ARE MANY AND SO DIFFERENT,
BUT DIVERSITY IS OUR UNIQUENESS.

A diversity of countries, cultures, customs, people,
that are forced to coexist.

In the companies there are different areas, profiles,
teams, projects and objectives. Each one with their
specific needs.

WE PROPOSE A TRIP THROUGH DIVERSITY.
IN A WORLD OF POSSIBILITIES.

NOUS SOMMES BEAUCOUP ET TRÈS DIFFÉRENTS MAIS
NOTRE SINGULARITÉ EST LA DIVERSITÉ.

Une diversité de pays, de cultures, de coutumes,
de personnes qui sont obligées à coexister.

À l'intérieur des entreprises ils existent différents, des áreas,
des profils, des équipes, des projets et des objectifs. Chacun
avec ses nécessités concrètes.

NOUS TE PROPOSONS UN VOYAGE PAR LA DIVERSITÉ.
PAR UN MONDE DE POSSIBILITÉS.

Más de 40 años aportando
soluciones integrales
a un sector en
constante evolución.

ISMOBEL cuenta con una infraestructura de 25.000m² situada estratégicamente con grandes ventajas logísticas y equipada con la tecnología necesaria para cada producto.

Un equipo de más de 100 personas, hace que ISMOBEL sea una empresa consolidada que aporta valor y conocimiento.



More than 40 years giving completed solutions to a sector in continuous evolution. ISMOBEL seating has a 25,000m² infrastructure located strategically with great logistics benefits and equipped with the necessary technology for each product.

A team of more than 100 people, makes jdm seating a consolidated company that provides value and knowledge.

**Our uniqueness,
our capacity for diversification.**



Plus de 40 ans en donnant des solutions intégrales à un secteur dans une évolution continue. ISMOBEL seating dispose d'une infrastructure de 25.000 M² située stratégiquement avec des grands avantages logistiques et équipée de la technologie nécessaire pour chaque produit.

Une équipe de plus de 100 personnes fait que jdm seating soit une entreprise consolidée qui apporte une valeur et une connaissance.

**Notre singularité,
notre capacité de diversification.**

NUESTRA
SINGULARIDAD,
NUESTRA CAPACIDAD
DE DIVERSIFICACIÓN.

Entendemos esta diversidad
y trabajamos para dar respuesta
a nuevas necesidades.

We understand this diversity and we work to give answers to new needs.

Nous entendons cette diversité et travaillons pour donner la réponse à des nouvelles nécessités.





25.000 m²



ECODISEÑO ISO 14006:2011

ENTENDEMOS UN MUNDO MEJOR MÁS SOSTENIBLE, MÁS JUSTO.

y es por ello que desde hace tiempo apostamos por tomar medidas que minimicen nuestro impacto sobre el medio ambiente, y toda nuestra superficie que consta de **25.000 m² está cubierta de placas solares.**

and that is why for some time we have been committed to taking measures that minimize our impact on the environment, and our entire surface, which consists of 25.000 m², is covered with solar panels.

et c'est pourquoi depuis un certain temps, nous nous sommes engagés à prendre des mesures qui minimisent notre impact sur l'environnement, et toute notre surface, qui se compose de 25.000 m², est couverte de panneaux solaires.

ISMOBEL, reúne en este catálogo las colecciones que vienen a cubrir las necesidades del sector del equipamiento de oficina y puestos de trabajo. Colecciones independientes y complementarias a su vez. Un objetivo que se cumple gracias al trabajo en equipo del departamento de diseño, diseñadores, departamento comercial y conversaciones con clientes.

THE SOLUTION

ISMOBEL, reúne en este catálogo las colecciones que vienen a cubrir las necesidades del sector del equipamiento de oficina y puestos de trabajo. Colecciones independientes y complementarias a su vez. Un objetivo que se cumple gracias al trabajo en equipo del departamento de diseño, diseñadores, departamento comercial y conversaciones con clientes.

ISMOBEL, reúne en este catálogo las colecciones que vienen a cubrir las necesidades del sector del equipamiento de oficina y puestos de trabajo. Colecciones independientes y complementarias a su vez. Un objetivo que se cumple gracias al trabajo en equipo del departamento de diseño, diseñadores, departamento comercial y conversaciones con clientes.

recepciones

RECEPTION / RÉCEPTION



12
PUBLIC



28
maya

OPERATIVO

OPERATIVE / OPERATIVE



34
argos



76
maya



106
teSEO



122
DELFOs



130
eco



136
CERES



156
SKY



164
FEDRA

DIRECCIÓN

EXECUTIVE / DIRECTION



176
zen



192
nereO 2



204
nereO 3

BIBLIOTECA Y DIVISORIAS

LIBRARIES AND DIVIDERS / BIBLIOTHÈQUES ET SÉPARATEURS



226
BIBLOS



246
HORUS



270
PANEL

ALMACENAJE

STORAGE / STOCKAGE



282



recepciones

RECEPTION / RÉCEPTION

12 PUBLIC

28 maya



PUBLIC

RECEPTION & COMMUNITY

Designed by
SIGFRIDO BILBAO

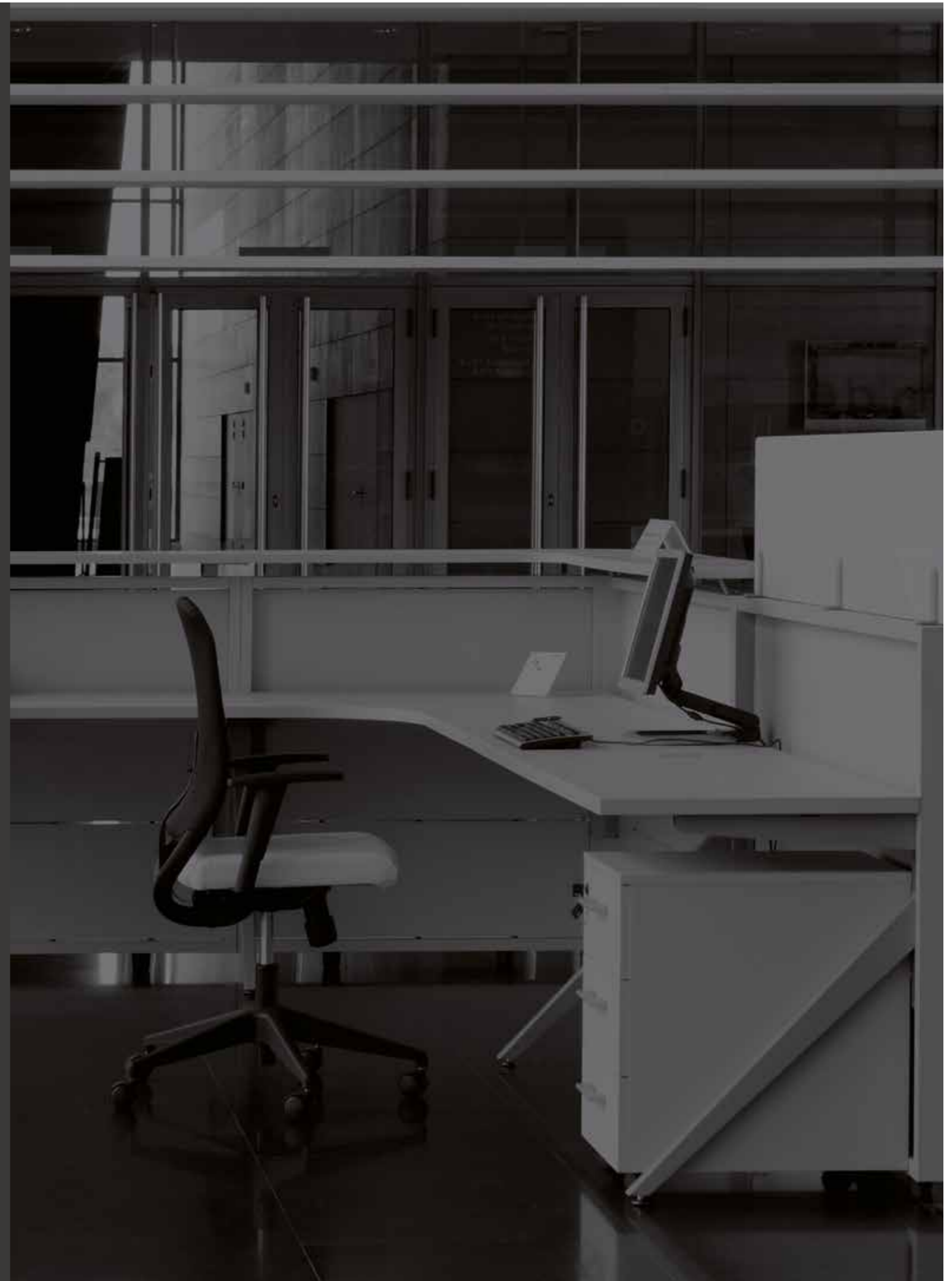

DESIGN BY:
SIGFRIDO BILBAO





















- Butacas Pares Fila 1 a 10
Stalls Even Row 1-10
- Butacas Fila 11 a 18
Stalls Row 11-18
- Salas de Reuniones 6,7,8 y 9
Conference Halls 6-7-8-9

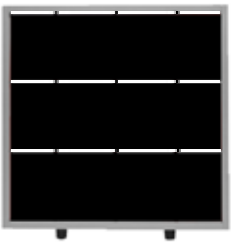

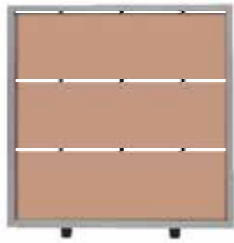
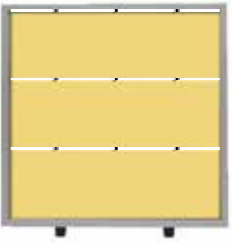

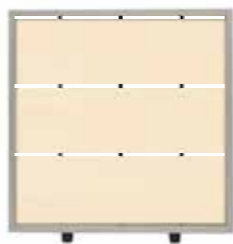

COLORES PANELES / Panel Finishes / Finitions Panneaux

				
BLANCO White / Blanc	GRIS Grey / Gris	ALUMINIO Aluminium / Aluminium	GRAFITO Grafhite / Anthracite	NEGRO Black / Noir
				
AZUL Blue / Bleu	NUDE Nude / Nude	AMARILLO Yellow / Jaune	VERDE Green / Vert	TERRACOTA Terracotta / Terre Cuite
				
ARCE Maple / Erable	ROBLE Oak / Poirier	HAYA Beech / Hêtre	BACO Baco / Baco	CEREZO Cherry / Mésisie



COLORES MARCOS / Frame Finishes / Finitions Cadres

BLANCO / White / Blanc

GRAFITO / Grafhite / Anthracite

ALUMINIO / Aluminium / Aluminium

COLORES ENCIMERAS / Top Finishes / Finitions Plateaux

					
NEGRO Black Noir	GRAFITO Grafhite Anthracite	GRIS Grey Gris	ALUMINIO Aluminium Aluminium	BLANCO White Blanc	CRISTAL Glass Vitrage
					
ARCE Maple Erable	BACO Baco Baco	HAYA Beech Hêtre	ROBLE Oak Poirier	CEREZO Cherry Mésisie	

PICTOS / PICTOGRAMS

 <table border="0"> <tr><td>A</td><td>B</td></tr> <tr><td>180</td><td>82</td></tr> <tr><td>160</td><td>82</td></tr> <tr><td>140</td><td>82</td></tr> <tr><td>120</td><td>82</td></tr> <tr><td>100</td><td>82</td></tr> <tr><td>80</td><td>82</td></tr> </table> <p>Mostrador recto Flat Counter Module droit</p>	A	B	180	82	160	82	140	82	120	82	100	82	80	82	 <table border="0"> <tr><td>B</td><td>A</td><td>B</td></tr> <tr><td>202</td><td>82</td><td>82</td></tr> <tr><td>182</td><td>82</td><td>82</td></tr> <tr><td>162</td><td>82</td><td>82</td></tr> <tr><td>202</td><td>82</td><td>82</td></tr> <tr><td>182</td><td>82</td><td>82</td></tr> <tr><td>162</td><td>82</td><td>82</td></tr> </table> <p>Mostrador giro interior 90° 90° inside return counter Module angle intérieur 90°</p>	B	A	B	202	82	82	182	82	82	162	82	82	202	82	82	182	82	82	162	82	82	 <table border="0"> <tr><td>A</td><td>B</td></tr> <tr><td>170</td><td>170</td></tr> </table> <p>Mostrador giro exterior 90° 90° outside return counter Module angle extérieur 90°</p>	A	B	170	170	 <table border="0"> <tr><td>A</td><td>h140</td><td>A</td><td>B</td></tr> <tr><td>180</td><td></td><td>70</td><td>70</td></tr> <tr><td>160</td><td></td><td>70</td><td>70</td></tr> <tr><td>140</td><td></td><td>70</td><td>70</td></tr> <tr><td>120</td><td></td><td>70</td><td>70</td></tr> <tr><td>100</td><td></td><td>70</td><td>70</td></tr> <tr><td>80</td><td></td><td>70</td><td>70</td></tr> </table> <p>Mostrador recto cristal vertical Flat counter with vertical glass Module droit vitré</p>	A	h140	A	B	180		70	70	160		70	70	140		70	70	120		70	70	100		70	70	80		70	70	 <table border="0"> <tr><td>A</td><td>B</td></tr> <tr><td>180</td><td>90</td></tr> <tr><td>160</td><td>90</td></tr> <tr><td>140</td><td>90</td></tr> <tr><td>120</td><td>90</td></tr> <tr><td>100</td><td>90</td></tr> <tr><td>80</td><td>90</td></tr> </table> <p>Mostrador recto discapacitados Flat counter for disabled Module droit handicapés</p>	A	B	180	90	160	90	140	90	120	90	100	90	80	90	 <table border="0"> <tr><td>A</td><td>B</td></tr> <tr><td>90</td><td>90</td></tr> </table> <p>Mostrador giro 90° discapacitados 90° return counter for disabled Module handicapés angle 90°</p>	A	B	90	90	 <table border="0"> <tr><td>A</td><td>B</td></tr> <tr><td>180</td><td>70</td></tr> <tr><td>160</td><td>70</td></tr> <tr><td>140</td><td>70</td></tr> <tr><td>120</td><td>70</td></tr> <tr><td>100</td><td>70</td></tr> <tr><td>80</td><td>70</td></tr> </table> <p>Mesa conferencias con panel Conference table with panel Table de conférence avec voile de fond</p>	A	B	180	70	160	70	140	70	120	70	100	70	80	70	 <table border="0"> <tr><td>A</td><td>B</td></tr> <tr><td>70</td><td>70</td></tr> </table> <p>Sobre giro/unión 90° conferencias 90° joining desk for conference tables Table de conférence angle/unión 90°</p>	A	B	70	70
A	B																																																																																																													
180	82																																																																																																													
160	82																																																																																																													
140	82																																																																																																													
120	82																																																																																																													
100	82																																																																																																													
80	82																																																																																																													
B	A	B																																																																																																												
202	82	82																																																																																																												
182	82	82																																																																																																												
162	82	82																																																																																																												
202	82	82																																																																																																												
182	82	82																																																																																																												
162	82	82																																																																																																												
A	B																																																																																																													
170	170																																																																																																													
A	h140	A	B																																																																																																											
180		70	70																																																																																																											
160		70	70																																																																																																											
140		70	70																																																																																																											
120		70	70																																																																																																											
100		70	70																																																																																																											
80		70	70																																																																																																											
A	B																																																																																																													
180	90																																																																																																													
160	90																																																																																																													
140	90																																																																																																													
120	90																																																																																																													
100	90																																																																																																													
80	90																																																																																																													
A	B																																																																																																													
90	90																																																																																																													
A	B																																																																																																													
180	70																																																																																																													
160	70																																																																																																													
140	70																																																																																																													
120	70																																																																																																													
100	70																																																																																																													
80	70																																																																																																													
A	B																																																																																																													
70	70																																																																																																													

maya

RECEPTION & COMMUNITY

Designed by
SIGFRIDO BILBAO



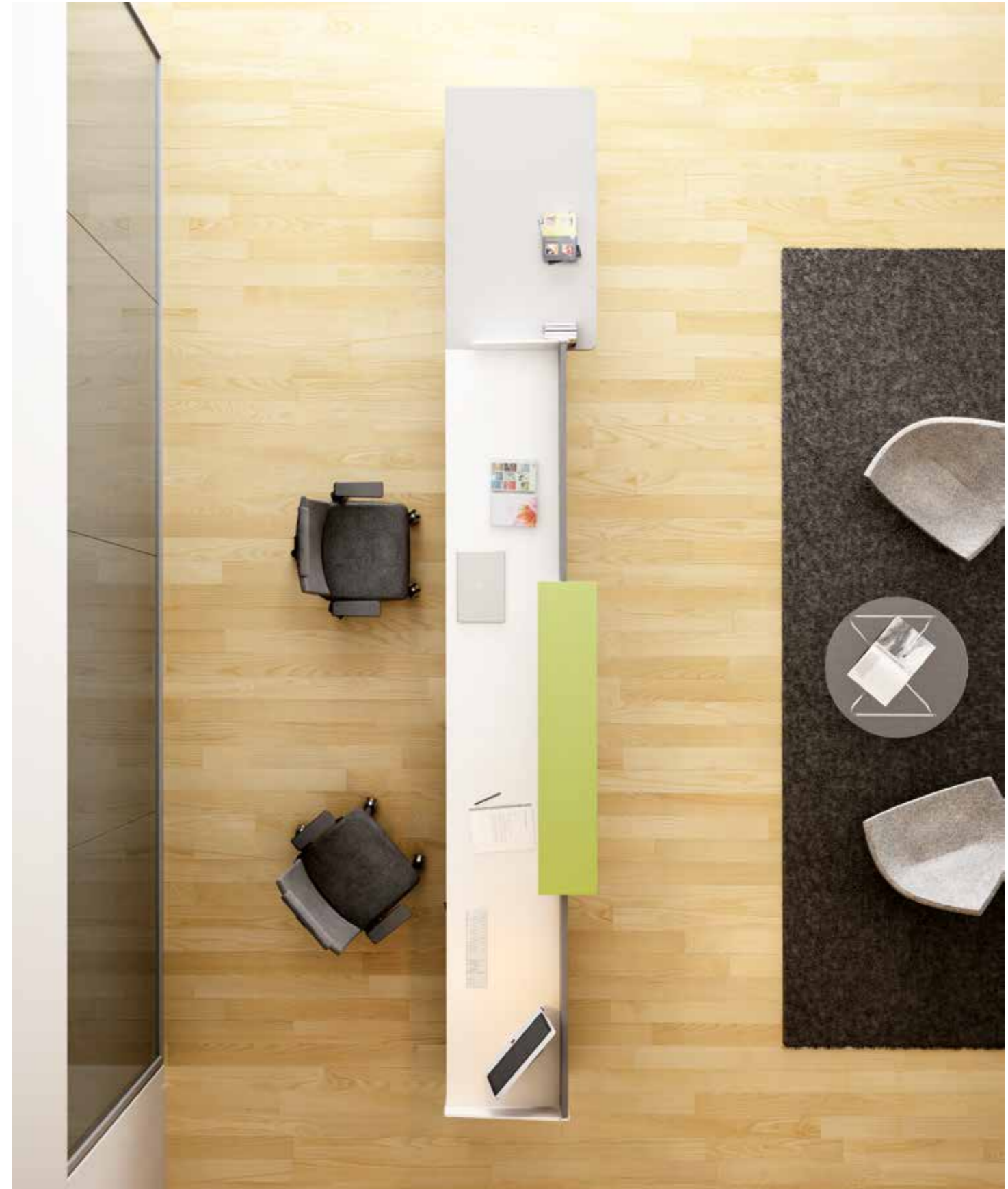

OPERATIVO

OPERATIVO / OPERATIVO

34	ARGOS
76	MAYA
106	TESEO
122	DELFO
130	ECO
136	CERES
156	SKY
164	FEDRA

ARGOS

EQUIPAMIENTO INTEGRAL DE OFICINA

Designed by
SIGFRIDO BILBAO

IS
ISMOBEL



ARGOS

EQUIPAMIENTO INTEGRAL DE OFICINA



Design by: SIGFRIDO BILBAO

ARGOS, UNA COLECCIÓN QUE SE ADAPTA A LA DIVERSIDAD DE NECESIDADES DE LOS LUGARES DE TRABAJO ACTUALES.

Su diversidad de formas y la particularidad del diseño de la pata, nos permite resolver el equipamiento para zonas de Dirección, puestos Operativos y Multipuesto, así como zonas de reunión, estas últimas totalmente integradas con puestos operativos.

ARGOS, A COLLECTION WHICH ADAPTS TO THE DIVER SITY OF THE NEEDS OF THE CURRENT WORK PLACES.

Its diversity of shapes and the particularity of the design of the leg allows us to solve the equipment for Management areas, task desks, workstations as well as meeting areas, this one fully integrated with task desks.

ARGOS, EST UNE COLLECTION QUE L'ON ADAPTE À LA DIVERSITÉ DE NÉCESSITÉS D'ACTUELS LIEUX DE TRAVAIL.

Sa diversité de formes et la particularité du dessin de la patte nous permet de résoudre l'équipement pour des zones de Direction, de postes Opérationnels et de Multiposte, ainsi que des zones de réunion, totalement intégrées avec postes opérationnels.



UP & DOWN

Las diferentes necesidades se dividen en diferentes espacios, diversas soluciones para cubrir esas necesidades.
PUESTOS OPERATIVOS MULTIDISCIPLINARES.

The different needs are divided into different spaces, different solutions to meet those needs.
MULTIDISCIPLINARY TASK DESKS.

Différents besoins sont divisés en différents espaces, il y a diverses solutions pour couvrir ces nécessités.
DES POSTES OPÉRATIONNELS MULTIDISCIPLINAIRES.





VERSATILITY

Este modelo presenta una gran versatilidad. La facilidad de generar composiciones diferentes permite adaptarnos a necesidades muy concretas.

This model presents great versatility. The facility to make different compositions allows us to adapt to very specific needs.

Ce modèle présente une grande versatilité. La facilité de générer différentes compositions permet de nous adapter aux nécessités très concrètes.

YOU & ME & US

Los espacios polivalentes son cada vez más necesarios en nuestros lugares de trabajo. La individualidad y la necesidad de reunirse, son acciones que determinan nuestro día a día.

ADAPTABILIDAD A LAS NECESIDADES

Multipurpose spaces are increasingly necessary in our workplaces. The individuality, and the need to meet are actions that determine our day to day.

ADAPTABILITY TO THE NEEDS

Les espaces polyvalents sont de plus en plus nécessaires dans nos lieux de travail. L'individualité, et la nécessité de se réunir ce sont des actions qu'ils déterminent le notre au jour le jour.

UNE ADAPTABILITÉ AUX NÉCESSITÉS



PLAY & STOP

El espacio en las oficinas tiene dos momentos, cuando trabajamos en él y cuando finalizamos la jornada. Es por eso que la modularidad de ARGOS nos permita redefinir el espacio en ambas situaciones.

The space in the offices has two moments, when we work on it and when we finish the day. That is why the modularity of ARGOS allows us to redefine the space in both situations.

L'espace dans les bureaux a deux moments, quand nous travaillons dans lui et quand nous finissons la journée. C'est par cela que la modularité ARGOS nous permet de redéfinir l'espace dans les deux situations.





ELEGANCE

La calidad de un espacio es importante y determinante en muchos casos para generar un ambiente de trabajo agradable. ARGOS nos brinda la posibilidad de mimetizarnos en ese entorno.

The quality of a space is important and determinant in many cases to generate a pleasant work environment. ARGOS offers us the possibility of mimicking ourselves in that environment.

La qualité d'un espace est important et déterminant dans beaucoup de cas pour générer une atmosphère de travail agréable. ARGOS nous offre la possibilité de nous imiter dans cet environnement.





PRIVACY

En la actualidad la privacidad es más importante que nunca. La modularidad y los sistemas de separación permiten la privacidad sin perder el contacto y la posibilidad de comunicación con otras personas.

Nowadays privacy is more important than ever. Modularity and separation systems allow privacy without losing contact and the possibility of communication with other people.

Actuellement la confidentialité est plus importante que jamais. La modularité et les systèmes de séparation permettent la confidentialité sans perdre le contact et la possibilité de communication avec d'autres personnes.

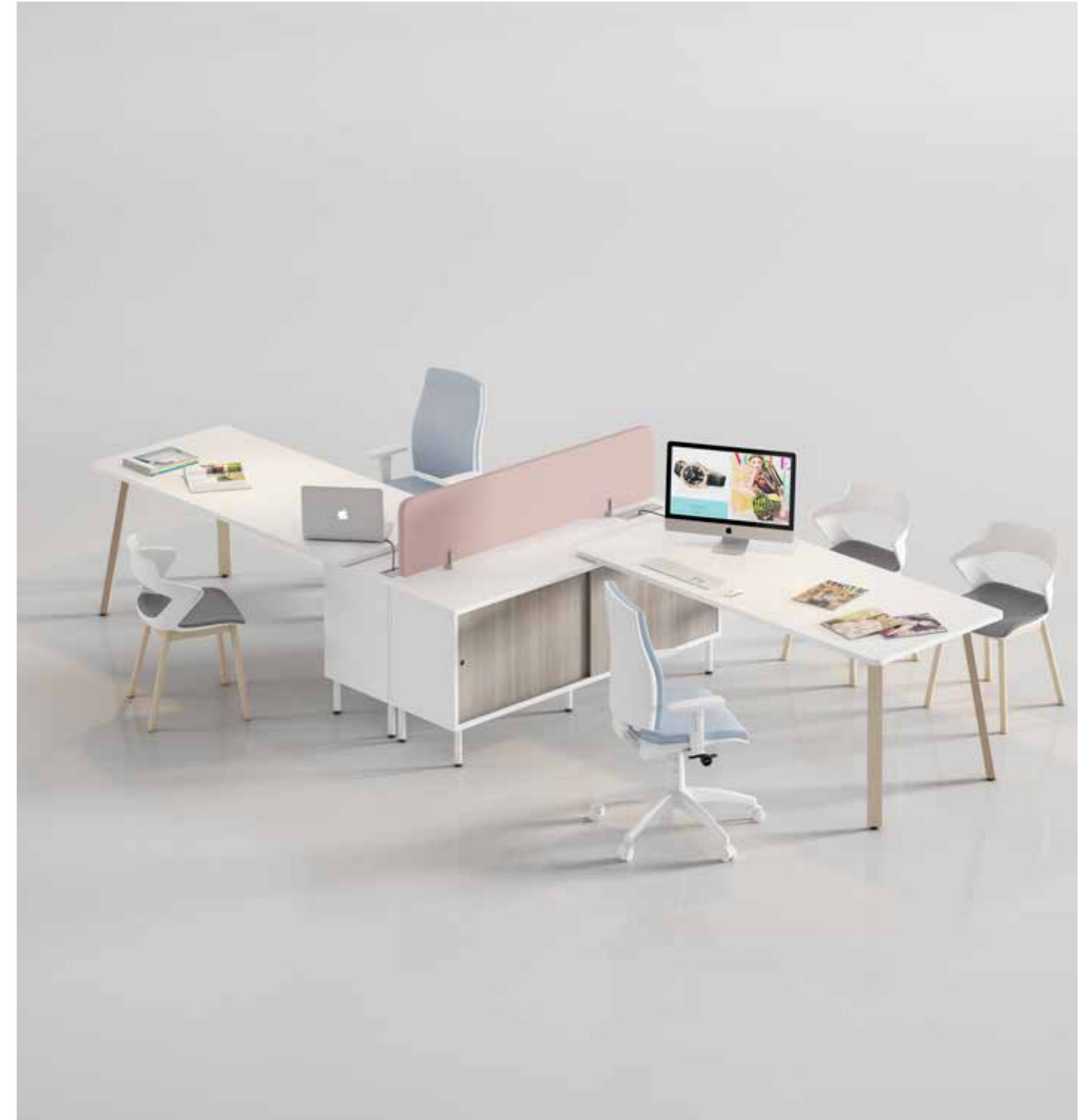

SINGULAR DIVERSITY

Dentro de la diversidad y la variedad, hay que prestar especial importancia a la singularidad de cada uno, de cada proyecto, de cada espacio.

Within diversity and variety, we must pay special importance to the uniqueness of each one, of each project, of each space.

Dans la diversité et la variété, il faut donner une importance spéciale à la singularité de chacun, de chaque projet, de chaque Espace.



Being part of a team is increasingly necessary to solve the challenges of day to day, but without losing the privacy of each of its members.

Faire partie d'une équipe est de plus en plus nécessaire pour résoudre les défis d'au jour le jour, mais sans perdre une confidentialité de chacun de ses membres.

COLLECTIVE PRIVACY

Formar parte de un equipo es cada vez más necesario para resolver los retos del día a día, pero sin perder la privacidad de cada uno de sus miembros.





Each business or personal project has particular needs. Modularity, give us individual or collective.

Chaque projet patronal ou personnel ils ont quelques nécessités particulières. Avec la modularité des espaces individuels ou collectifs sont obtenus.

ONLY & TOGETHER

Cada proyecto empresarial o personal tiene unas necesidades particulares. Con la modularidad se consiguen espacios individuales o colectivos.

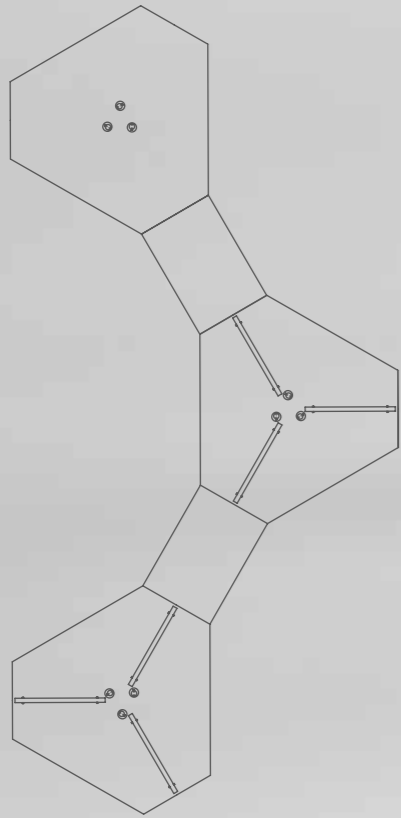



MEETING & WORKING

Alternar los momentos de trabajo con los de compartir información y proyectos con el equipo, son cada vez más habituales. Estas situaciones generan necesidades en las que ARGOS da respuesta a ambas demandas.

Alternating working moments with those of sharing information and projects with the team are becoming more common. These situations generate needs in which ARGOS responds to both demands.

Alternar los momentos de trabajo con los de compartir información y proyectos con el equipo son de más en más habituales. Estas situaciones generan las necesidades en las que ARGOS da respuesta a ambas demandas.

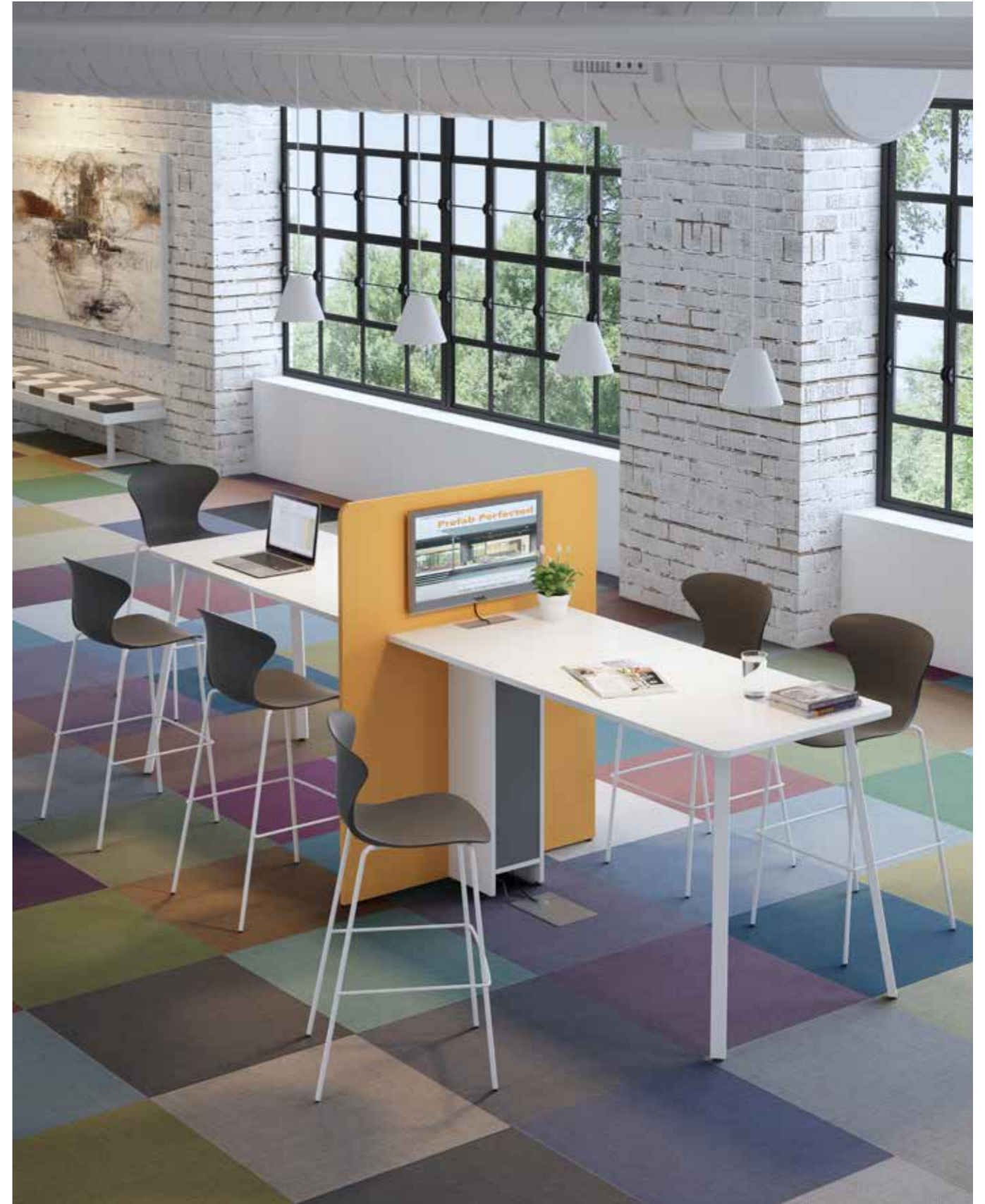



LIBRARY

Espacios polivalentes para informarse, reunirse, estudiar, exigen de soluciones inteligentes para adaptarse a cada situación y a la demanda del usuario.

Multipurpose spaces for information, meeting, studying, demand intelligent solutions to adapt to each situation and user demand.

Des espaces polyvalents pour être informé, pour se réunir, étudier, ils exigent des solutions intelligentes pour s'adapter à chaque situation et à la demande de l'utilisateur.









The storage spaces are an indispensable complement in the work spaces. The modularity and accessibility to the information or to the elements that we keep is important. ARGOS is a system that allows you to modularize and concatenate your different models.

Les espaces de stockage sont un complément indispensable dans les espaces de travail. La modularité et l'accessibilité à l'information ou aux éléments que nous gardons c'est important. ARGOS est un système qui permet modulariser et enchaîner ses différents modèles.



IN & OUT

Los espacios de almacenaje son un complemento indispensable en los lugares de trabajo. La modularidad y accesibilidad a la información o a los elementos que guardamos es importante. ARGOS es un sistema que permite modularizar y concatenar sus diferentes modelos.



ACABADOS FINISHINGS / FINITIONS

MELAMINAS MELAMINE / MÉLAMINES



NEGRO
BLACK
NOIR

GRAFITO
GRAPHITE
ANTHRACITE

GRIS
GREY
GRIS

ALUMINIO
ALUMINIUM
ALUMINIUM

BLANCO
WHITE
BLANC



ARCE
MAPLE
ERABLE

BACO
BACO
BACO

HAYA
BEECH
HÊTRE

ROBLE
OAK
POIRIER

CEREZO
CHERRY
MÉRISIE

Los colores de este catálogo son orientativos, la percepción de los mismos puede variar respecto al original.

The colours of this catalogue are reference, the perception of the same can vary with respect to the original one.

Les couleurs figurant sur le catalogue sont indicatifs, ils peuvent varier para rapport à l'original.

ELEMENTOS VERTICALES VERTICAL ELEMENTS / ÉLÉMENTS VERTICAUX



AZUL
BLUE
BLEU

NUDE
NUDE
NUDE

VERDE
GREEN
VERT



AMARILLO
YELLOW
JAUNE

TERRACOTA
TERRACOTTA
TERRE CUITE

ACABADOS PATAS LEG FINISH / FINITION DES JAMBES



NEGRO
BLACK
NOIR

ALUMINIO
ALUMINIUM
ALUMINIUM

BLANCO
WHITE
BLANC

TAPAS TOPS / TABLETTES

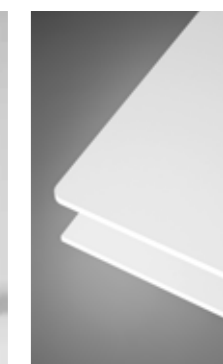

CANTO RECTO
STRAIGHT EDGE
BORD DROIT

CANTO CURVO
CURVED EDGE
BORD COURBE

MADERA
WOOD
MADÈRE

maya

EQUIPAMIENTO INTEGRAL DE OFICINA

Designed by
SIGFRIDO BILBAO





Design by: SIGFRIDO BILBAO



DIRECCIÓN
MANAGEMENT / DIRECTION

OPERATIVO
OPERATIVE / OPÉRATIVE

BENCH
BENCH / BENCH

REUNIÓN FORMACIÓN
MEETING TRAINING / RÉUNION FORMATION

BIBLIOTECA
LYBRARY / BIBLIOTHÈQUE

ACABADOS
FINISHINGS / FINITIONS

TÉCNICO
TECHNICAL / TECHNIQUE

**SOLUCIONES OPERATIVAS,
MÁXIMO APROVECHAMIENTO
DE ESPACIOS, RACIONALIDAD
DE ARCHIVOS.**

OPERATIVE SOLUTIONS,
OPTIMAL USE OF THE SPACE,
RATIONAL FILING CABINET

SOLUTIONS OPÉRATIONNELLES,
OPTIMISATION DES VOLUMES,
RATIONALISATION DES
RANGEMENTS

DIRECCIÓN

MANAGEMENT / DIRECTION

















BENCH

BENCH / BENCH





REUNIÓN FORMACIÓN

MEETING TRAINING / RÉUNION FORMATION



BIBLIOTECA

LIBRARY / BIBLIOTHÈQUE



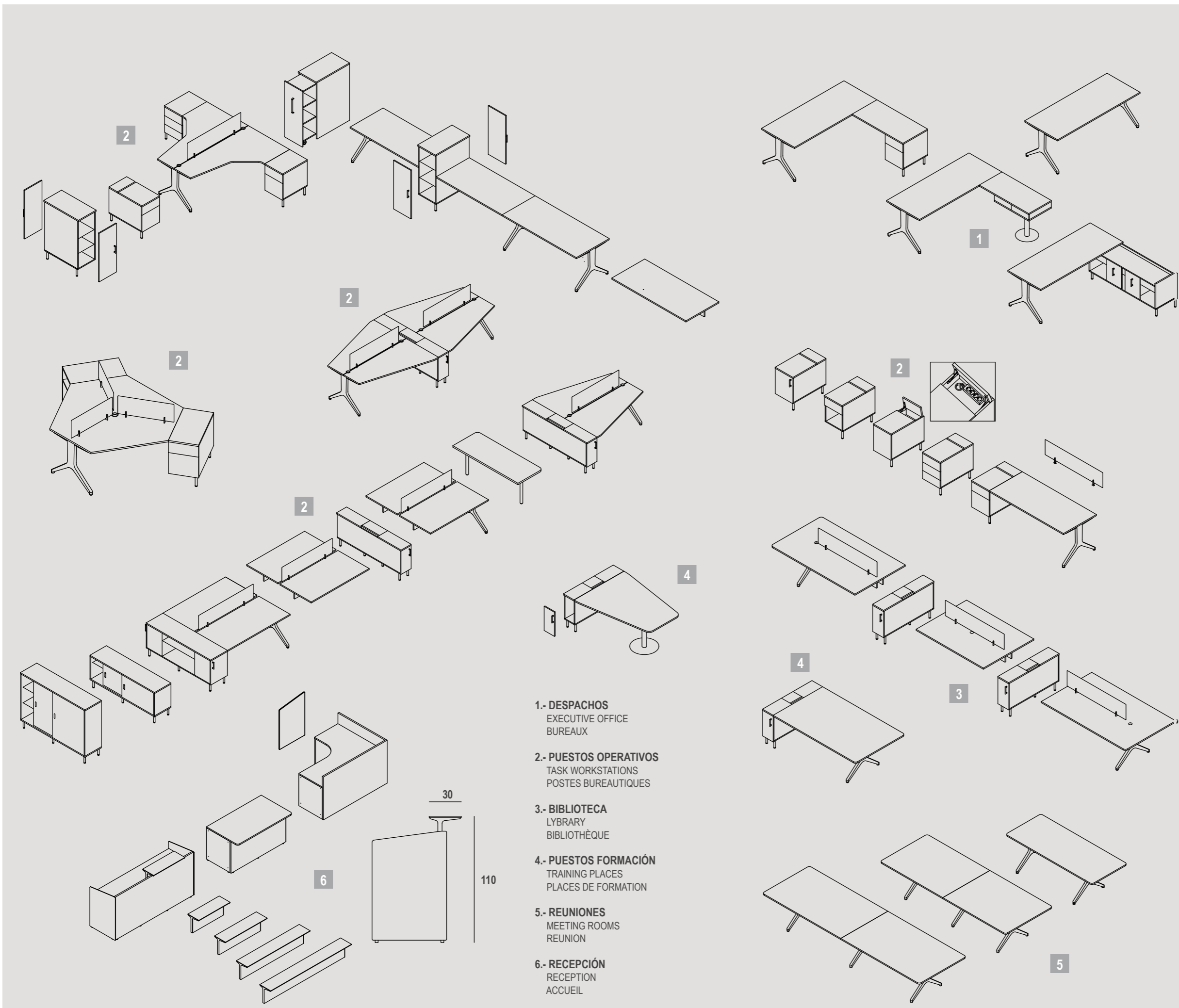

- 1.- DESPACHOS
EXECUTIVE OFFICE
BUREAUX
- 2.- PUESTOS OPERATIVOS
TASK WORKSTATIONS
POSTES BUREAUTIQUES
- 3.- BIBLIOTECA
LYBRARY
BIBLIOTHÈQUE
- 4.- PUESTOS FORMACIÓN
TRAINING PLACES
PLACES DE FORMATION
- 5.- REUNIONES
MEETING ROOMS
REUNION
- 6.- RECEPCIÓN
RECEPTION
ACCUEIL

ACABADOS

FINISHINGS / FINITIONS

Los colores de este catálogo son orientativos, la percepción de los mismos puede variar respecto al original.

The colours of this catalogue are reference, the perception of the same can vary with respect to the original one.

Les couleurs figurant sur le catalogue sont indicatifs, ils peuvent varier para rapport à l'original.



ELEMENTOS VERTICALES VERTICAL ELEMENTS / ÉLÉMENTS VERTICAUX

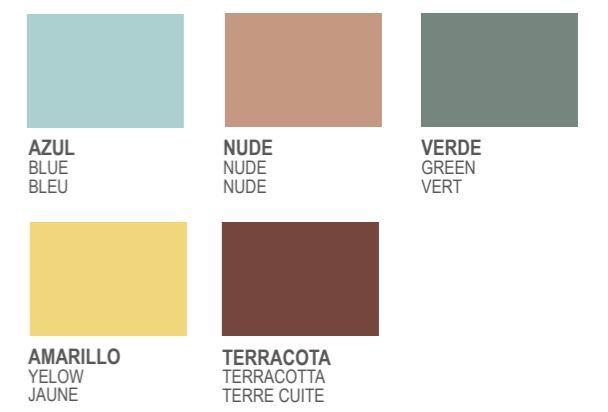

ACABADOS METÁLICOS METAL FINISHING / METAL FINITIONS



ACABADOS PATAS / LEG FINISH / FINITION DES JAMBES



teseo

EQUIPAMIENTO INTEGRAL DE OFICINA

Designed by
ISMOBEL



DIRECCIÓN

MANAGEMENT / DIRECTION 02>03



TESEO
EQUIPAMIENTO
INTEGRAL
DE OFICINA



DIRECCIÓN

MANAGEMENT / DIRECTION

EQUIPAMIENTO INTEGRAL DE OFICINA

Planificar y ser eficaces en todo tipo de proyectos, es importante para que todos los elementos se ajusten a las necesidades de cada una de las diferentes particularidades.

DELFO cuenta con la versatilidad que viene a solucionar estas necesidades.



EQUIPMENT OFFICE INTEGRAL

Planning and being effective in all types of projects, it is important for all elements to meet the needs of each of the different features.

DELFO has the versatility that comes to solve these needs.

EQUIPEMENT BUREAU INTÉGRAL

Planification et efficacité dans tous les types de projets, il est important que tous les éléments répondent aux besoins de chacune des différentes fonctionnalités.

DELFO a la polyvalence nécessaire pour répondre à ces besoins.



instalación
INSTALLATION / INSTALLATION

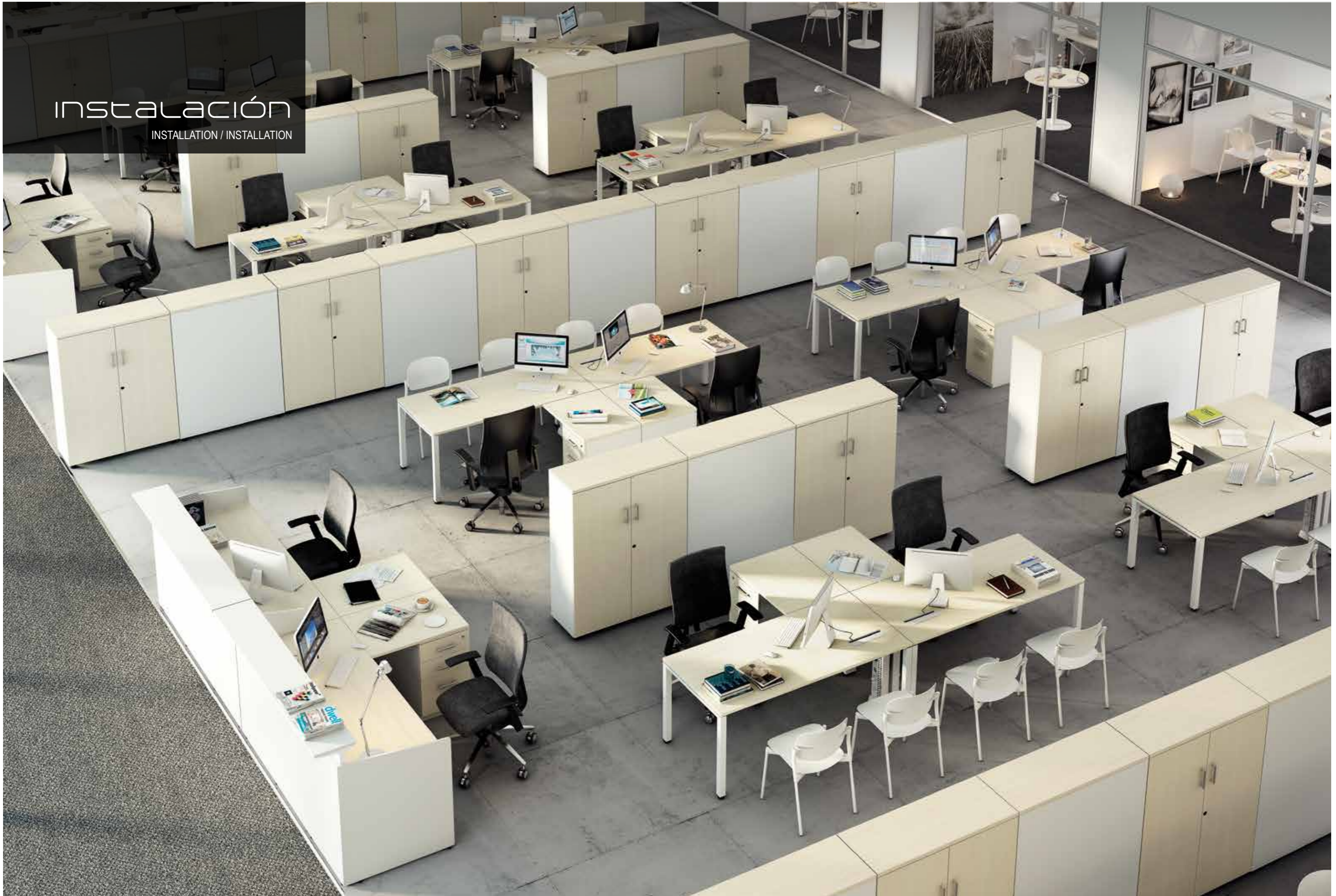

reunión
OPERATIVE / OPÉRATIVE



OPERATIVO

OPERATIVE / OPÉRATIVE



OPERATIVO

OPERATIVE / OPÉRATIVE



OPERATIVO

OPERATIVE / OPÉRATIVE



NEGRO BLACK / NOIR
GRAFITO GRAPHITE/ANTHRACITE
GRIS GREY / GRIS
ALUMINIO ALUMINIUM/ALUMINIUM
BLANCO WHITE / BLANC



ARCE MAPLE / ERABLE
BACO BACO / BACO
HAYA BEECH / HÊTRE
ROBLE OAK / POIRIER
CEREZO CHERRY / MÉRISIE

ELEMENTOS VERTICALES
 VERTICAL ELEMENTS / ÉLÉMENTS VERTICAUX



AZUL BLUE / BLEU
NUDE NUDE / NUDE
VERDE GREEN / VERT
AMARILLO YELLOW / JAUNE
TERRACOTA TERRACOTTA / TERRE CUITE

acabados

FINISHINGS / FINITIONS

Los colores de este catálogo son orientativos, la percepción de los mismos puede variar respecto al original.

The colours of this catalogue are reference, the perception of the same can vary with respect to the original one.

Les couleurs figurant sur le catalogue sont indicatifs, ils peuvent varier para rapport à l'original.

ACABADOS METÁLICOS
 METAL FINISHING / METAL FINITIONS



NEGRO (*) BLACK / NOIR
ALUMINIO ALUMINIUM / ALUMINIUM
BLANCO WHITE / BLANC

(*)
 NO STANDAR / Consulter
 NON-STANDARD / Consult
 NON STANDARD / Consulter

DELFOS

EQUIPAMIENTO INTEGRAL DE OFICINA





OPERATIVE / OPÉRATIVE
Operativo



MANAGEMENT / DIRECTION
DIRECCIÓN



TRAINING / FORMATION
Formación





BENCH / BENCH
BENCH

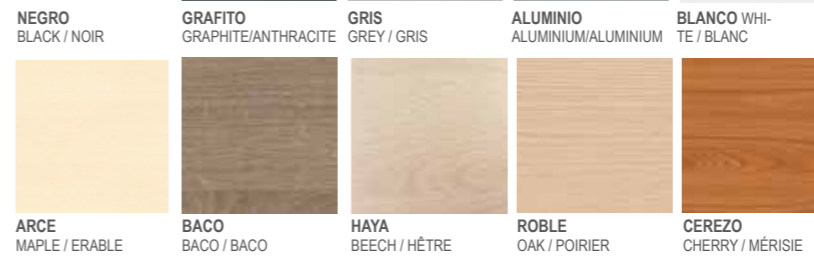

ELEMENTOS VERTICALES
VERTICAL ELEMENTS / ÉLÉMENTS VERTICAUX



AZUL / BLUE / BLEU
NUDE / NUDE / NUDE
VERDE / GREEN / VERT
AMARILLO / YELLOW / JAUNE
TERRACOTA / TERRACOTTA / TERRE CUITE

acabados
FINISHINGS / FINITIONS

Los colores de este catálogo son orientativos, la percepción de los mismos puede variar respecto al original.

The colours of this catalogue are reference, the perception of the same can vary with respect to the original one.

Les couleurs figurant sur le catalogue sont indicatifs, ils peuvent varier para rapport à l'original.

ACABADOS METÁLICOS
METAL FINISHING / METAL FINITIONS



NEGRO (*) / BLACK / NOIR
ALUMINIO (*) / ALUMINIUM / ALUMINIUM
BLANCO / WHITE / BLANC

(*) NO STANDARD / Consultar
NON-STANDARD / Consult
NON STANDARD / Consulter

eco

EQUIPAMIENTO INTEGRAL DE OFICINA

Designed by
ISMOBEL

IS
ISMOBEL

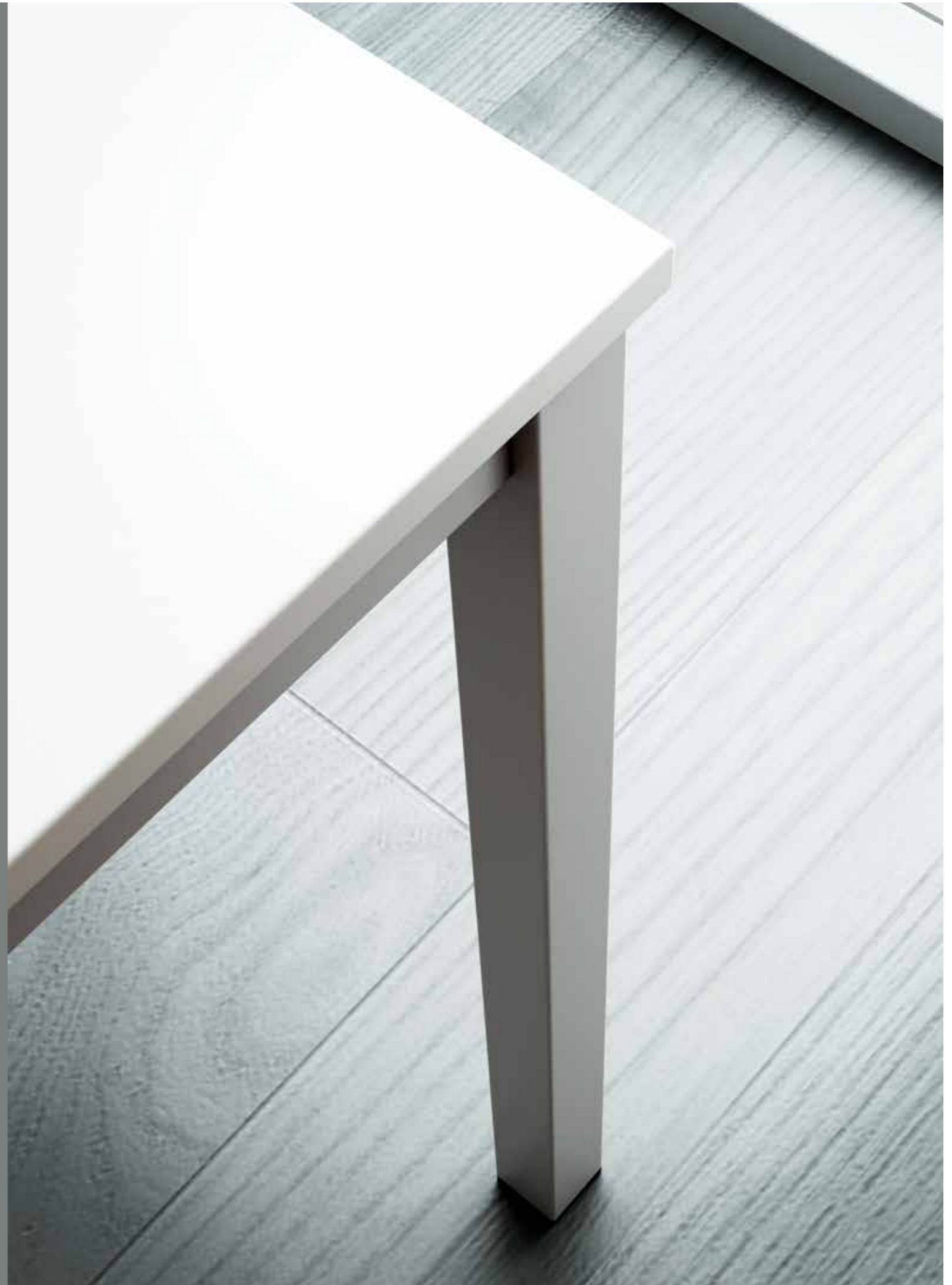



MEETING / RÉUNION
reunión



POLYVALENT / POLYVALENTE
MULTIUSOS



MANAGEMENT / DIRECCIÓN
DIRECCIÓN



TRAINNIG / FORMATION
Formación











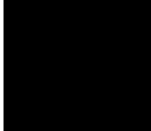
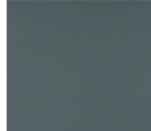
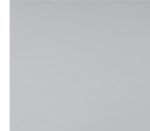

acabados

FINISHINGS / FINITIONS

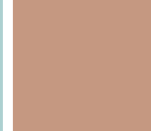
Los colores de este catálogo son orientativos, la percepción de los mismos puede variar respecto al original.

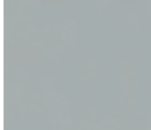
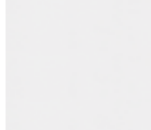
The colours of this catalogue are reference, the perception of the same can vary with respect to the original one.

Les couleurs figurant sur le catalogue sont indicatifs, ils peuvent varier para rapport à l'original.

								
NEGRO BLACK NOIR	GRAFITO GRAPHITE ANTHRACITE	GRIS GREY GRIS	ARCE MAPLE ERABLE	BACO BACO BACO	HAYA BEECH HÊTRE	AZUL BLEU BLEU	NUDE NUDE NUDE	VERDE GREEN VERT
								
ALUMINIO ALUMINIUM ALUMINIUM	BLANCO WHITE BLANC	ROBLE OAK POIRIER	CEREZO CHERRY MÉRISIE	AMARILLO YELLOW JAUNE	TERRACOTA TERRACOTTA TERRE CUITE			

ACABADOS METÁLICOS

METAL FINISHING / METAL FINITIONS

		
NEGRO (*) BLACK / NOIR	ALUMINIO ALUMINIUM / ALUMINIUM	BLANCO WHITE / BLANC

(*) NO STANDARD / Consulter
NON-STANDARD / Consult
NON STANDARD / Consulter

CERES

EQUIPAMIENTO INTEGRAL DE OFICINA

Designed by
Sigfrido Bilbao

IS
ISMOBEL





UN DISEÑO ARMÓNICO
 EN SUS FORMAS Y RACIONAL EN SU
 IMPLANTACIÓN, ORIENTADO A LOS EN-
 TORNOS DONDE PRIMA LA PRODUCTI-
 VIDAD, LA EFECTIVIDAD DEL ESPACIO
 DE TRABAJO Y LA ERGONOMÍA.

Design by: SIGFRIDO BILBAO

*Un dessin harmonique dans les formes et ra-
 tionnel dans s'implantation. C'est adressé au
 environnement où est prioritaire la producti-
 vité, l'efficacité du espace et l'ergonomie.*

DIRECCIÓN



OPERATIVO





CERES

UN DISEÑO CREADO Y DESARROLLADO EN EL AÑO 2003
PARA PERPETUARSE EN EL TIEMPO.

CERES
a design created and developed
in 2003 to perpetuate in time.

CERES
c'est un dessin fait et développé
dans l'année 2003 pour se perpétuer
dans le temp.





**ATEMPORAL
Y DE TENDENCIA**
ASÍ SON LOS RASGOS PRINCIPALES
QUE DEFINEN ESTA SERIE

*Timeless and trendy, the main features
that define this series are.*

*C'est un dessin intemporel et avec ten-
dance. De sorte qu'ils sont les caracté-
ristiques principaux de cette série.*



CERES,
MANTENIENDO SU ESENCIA, ACTUALIZA Y
AMPLÍA SU GAMA PARA ADAPTARSE A LAS
NUEVAS ESTRUCTURAS DE TRABAJO.

*CERES,
with its own essence, updated and expands its
range to adapt itself to new ways of working.*

*CERES,
toujours avec s'essence, actualisé et aussi il
agrandi la gamme de produits, pour s'adapter au
les nouvelles structures de travail.*



REUNIÓN







ALMACENAJE



ACABADOS FINISHES / FINITIONS

Los colores de este catálogo son orientativos, la percepción de los mismos puede variar respecto al original.

The colours of this catalogue are reference, the perception of the same can vary with respect to the original one.

Les couleurs figurant sur le catalogue sont indicatifs, ils peuvent varier para rapport à l'original.

ELEMENTOS VERTICALES VERTICAL ELEMENTS / ÉLÉMENTS VERTICAUX



NEGRO
BLACK
NOIR

AZUL
BLUE
BLEU

NUDE
NUDE
NUDE



VERDE
GREEN
VERT

AMARILLO
YELLOW
JAUNE

TERRACOTA
TERRACOTTA
TERRE CUITE

ACABADOS GENERALES GENERAL FINISHES / FINITIONS GÉNÉRALES



NEGRO
BLACK
NOIR

GRAFITO
GRAPHITE
ANTHRACITE

GRIS
GREY
GRIS

ALUMINIO
ALUMINIUM
ALUMINIUM

BLANCO
WHITE
BLANC



BACO
BACO
BACO

HAYA
BEECH
HÊTRE

ROBLE
OAK
POIRIER

CEREZO
CHERRY
MÉRISIE

SKY

MOBILITY SYSTEMS

Designed by
ISMOBEL



SKY

Sentirse cómodo en cada situación es importante para desempeñar una tarea diferente en cada momento.



Feeling comfortable in each situation is important to perform a different task in each moment.

Se sentir confortable dans chaque situation est important pour accomplir une tâche différente à chaque moment.

SKY
MOBILITY SYSTEMS



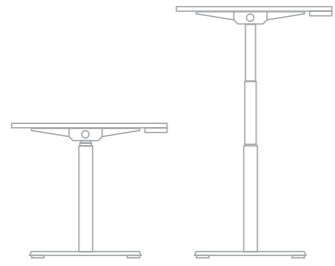

OPERATIVO

OPERATIVE / OPÉRATIVE

UP... DOWN

En un mismo espacio, en diferentes momentos, SKY se adapta a tí.
¿QUÉ NECESITAS?



*In the same space, at different times,
SKY adapts to you.*

WHAT DO YOU NEED?

*Dans le même espace, à des moments
différents, SKY s'adapte à vous.*

DE QUOI AVEZ-VOUS BESOIN?



SKY

ACABADOS / FINISHINGS / FINITIONS



NEGRO BLACK / NOIR	GRAFITO GRAPHITE / ANTHRACITE	GRIS GREY / GRIS	ALUMINIO ALUMINIUM / ALUMINIUM	BLANCO WHITE / BLANC
ARCE MAPLE / ERABLE	BACO BACO / BACO	HAYA BEECH / HÊTRE	ROBLE OAK / POIRIER	CEREZO CHERRY / MÉRISIE

MELAMINAS

MELAMINE
MÉLAMINES

AZUL BLEU / BLEU	NUDE NUDE / NUDE	VERDE GREEN / VERT	AMARILLO YELLOW / JAUNE	TERRACOTA TERRACOTTA / TERRE CUITE

ELEMENTOS VERTICALES

VERTICAL ELEMENTS
ÉLÉMENTS VERTICAUX

NEGRO (*) BLACK / NOIR	ALUMINIO ALUMINIUM / ALUMINIUM	BLANCO WHITE / BLANC

(*)
NO STANDARD / Consulter
NON-STANDARD / Consulter
NON STANDARD / Consulter

ACABADOS METÁLICOS

METAL FINISHING
METAL FINITIONS

Los colores de este catálogo son orientativos, la percepción de los mismos puede variar respecto al original.

The colours of this catalogue are reference, the perception of the same can vary with respect to the original one.

Les couleurs figurant sur le catalogue sont indicatifs ils peuvent varier para rapport à l'original.

FEDra

MOBILITY SYSTEMS

Designed by
ISMOBEL



FEDra

La versatilidad y funcionalidad de esta serie como factor diferenciador en entornos cambiantes.



The versatility and functionality of this series as a differentiating factor in changing environments.

La polyvalence et la fonctionnalité de cette série comme facteur différentiel dans des environnements changeants.

REUNIÓN

MEETING / RÉUNION



Cada ocasión precisa de una necesidad, una manera diferente de abordar el problema, por eso FEDRA es una herramienta que permite solucionar cualquier necesidad,
FÁCIL, RÁPIDO Y VERSÁTIL.

RE/CONFIGURA



Each occasion requires a must, a different way to solve the problem, so FEDRA is a tool that can solve any need.

EASY, FAST AND VERSATILE.

Chaque occasion a besoin d'une nécessité, une manière différente d'aborder le problème, c'est pourquoi FEDRA est un outil qui permet de répondre à n'importe quel besoin.

FACIL, RAPIDE ET POLYVALENT.



Una formación clásica con un elemento contemporáneo, una solución inmediata a un momento concreto.

A classic training with a contemporary element, an immediate solution to a specific moment.

Une formation classique avec un élément contemporain, une solution immédiate à un moment spécifique.

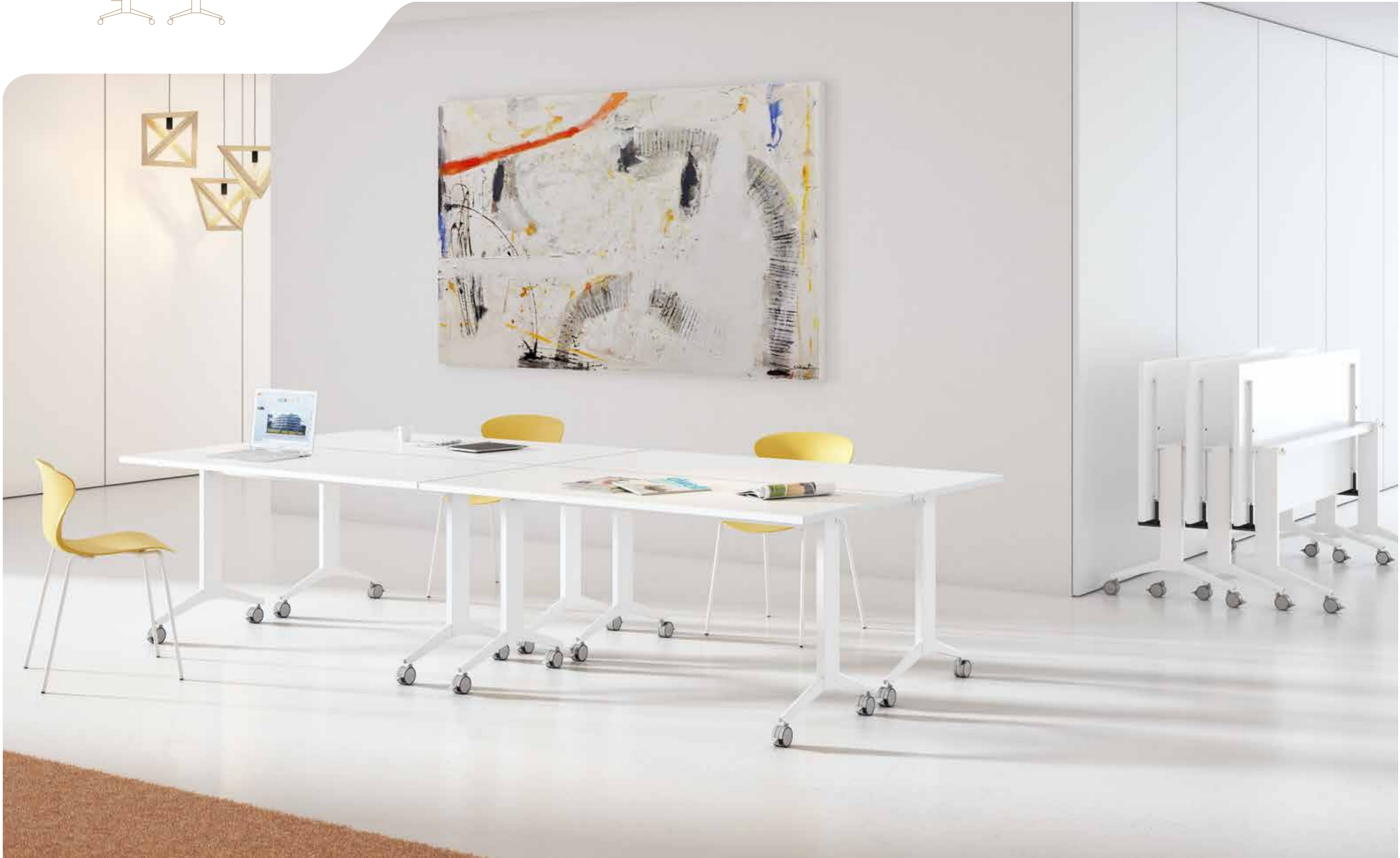
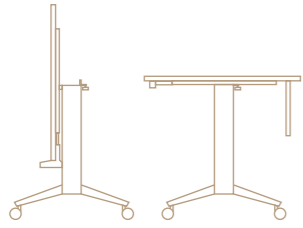



FEDRA

ACABADOS / FINISHINGS / FINITIONS



NEGRO BLACK / NOIR
GRAFITO GRAPHITE / ANTHRACITE
GRIS GREY / GRIS
ALUMINIO ALUMINIUM / ALUMINIUM
BLANCO WHITE / BLANC



ARCE MAPLE / ERABLE
BACO BACO / BACO
HAYA BEECH / HÊTRE
ROBLE OAK / POIRIER
CEREZO CHERRY / MÉRISIE

MELAMINAS
 MELAMINE
 MÉLAMINES



AZUL BLEU / BLEU
NUDE NUDE / NUDE
VERDE GREEN / VERT
AMARILLO YELLOW / JAUNE
TERRACOTA TERRACOTTA / TERRE CUITE

ELEMENTOS VERTICALES
 VERTICAL ELEMENTS
 ÉLÉMENTS VERTICAUX



NEGRO (*) BLACK / NOIR
ALUMINIO ALUMINIUM / ALUMINIUM
BLANCO WHITE / BLANC

(*) NO STANDAR / Consulter
 NON-STANDARD / Consult
 NON STANDARD / Consulter

ACABADOS METÁLICOS
 METAL FINISHING
 METAL FINITIONS

Los colores de este catálogo son orientativos, la percepción de los mismos puede variar respecto al original.

The colours of this catalogue are reference, the perception of the same can vary with respect to the original one.

Les couleurs figurant sur le catalogue sont indicatifs ils peuvent varier para rapport à l'original.



DIRECCIÓN

EXECUTIVE / DIRECTION

176 zen

192 nereeo 2

204 nereeo 3



zen

MOBILIARIO DE DIRECCIÓN

Designed by
SIGFRIDO BILBAO

IS
ISMOBEL



Mesa sobre armarios con rinconera. Roble / Blanco.
Silla modelo Oxford.
Confidente modelo Níger.



ZEN

Mobiliario de Dirección

La palabra ZEN es la abreviación de Zenna que es la pronunciación en japonés de la palabra china chánna, que a su vez deriva de la palabra sánscrita dhiana, que significa "meditación". El zen busca la experiencia de la sabiduría más allá del discurso racional.

Desde esta filosofía y concepto, **Ismobel** ha desarrollado una renovada línea de Mobiliario de Dirección, ZEN.

La importancia de tomar decisiones, bien meditadas.

The word ZEN is the abbreviation of Zenna which is the pronunciation in Japanese of the Chinese word chánna, which also derives from the Sanskrit word dhiana, which means "meditation". The Zen seeks the experience of wisdom beyond rational discourse.

From this philosophy and concept, **Ismobel** has developed a renewed line of Management Furniture, ZEN.

The importance of making decisions, well thought out.

Le mot zen est l'abrégement de zenna qui est la prononciation un japonais du mot chinois chánna qui dérive à son tour du mot Sanscrit Dhiana qui signifie "méditation". Le Zen cherche l'expérience de la sagesse plus loin du discours rationnel.

Depuis cette philosophie et concept, **Ismobel** a développé une ligne renouvelée et rénovée de mobilier de direction, Zen.

L'importance de prendre des décisions, bien médités.

*Mesa sobre armarios. Blanco.
Silla modelo Siena.
Confidente modelo Riga.*



Mesa sobre armarios de diferente altura. Blanco / Roble.
Silla modelo Bonn.
Confidente modelo Níger.
Sofá modelo Glasgow.



*Mesa con ala y cajonera. Ceniza / Inoxidable.
Armarios con casillero grande. Ceniza / Blanco.
Silla modelo Bonn.*



*Mesa reunión. Ceniza / Inoxidable.
Silla modelo Sevilla.*



Mesa sobre armarios. Blanco / Negro.
Silla modelo Siena.
Confidente modelo Riga.





DETALLES

Details / Des Détails

La serie ZEN se caracteriza por el acabado en todos sus detalles. Una ejecución muy cuidada que transmite carácter a esta serie.

The ZEN series is characterized by the finish in all its details. A very careful execution that transmits character to this series.

La série ZEN est caractérisée par achevé dans tous ses détails. Une exécution très soignée qui transmet un caractère à cette série.



nerEO 2

MOBILIARIO DE DIRECCIÓN

Designed by
SIGFRIDO BILBAO



DIRECCIÓN

Reception / Réception





REUNIÓN

Meeting / Réunion

CLÁSICO
Classic / Classique







CONTEMPORÁNEO
Contemporary / Contemporain

nerEO 3

MOBILIARIO DE DIRECCIÓN

Designed by
SIGFRIDO BILBAO

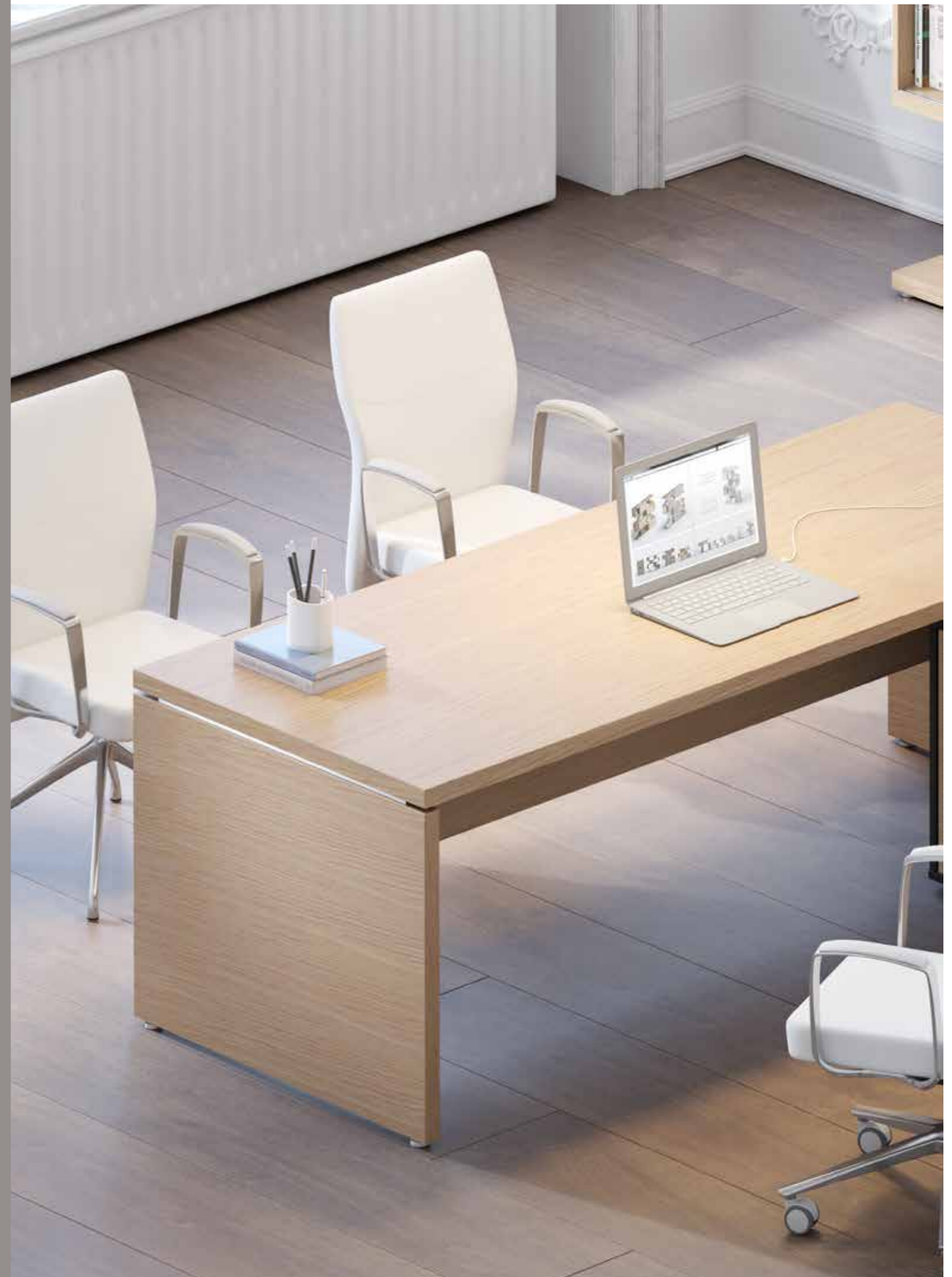



Management

Elegant and functional, straight lines that outline seriousness and integration with the environment. NEREO 3 adapts to the most demanding needs in each of its functions.

Direction

Lignes droites élégantes et fonctionnelles qui soulignent le sérieux et l'intégration avec l'environnement. NEREO 3 s'adapte aux besoins les plus exigeants dans chacune de ses fonctions.

Dirección

Elegante y funcional, líneas rectas que perfilan seriedad e integración con el entorno. NEREO 3 se adapta a las más exigentes necesidades en cada una de sus funciones.



Diversidad

Un mismo espacio con diferentes necesidades en puestos de trabajo. Una convivencia de las diferentes soluciones que aporta equilibrio a la composición de espacios multidisciplinarios.

Diversity

The same space with different needs in jobs. A coexistence of the different solutions that brings balance to the composition of multidisciplinary spaces.

Diversité

Le même espace avec des besoins différents dans les emplois. Une coexistence des différentes solutions qui équilibre la composition des espaces pluridisciplinaires.



Configuración

Ante una misma necesidad, NEREO 3 aporta diferentes soluciones y configuraciones pensadas para cada usuario.



Setting

Faced with the same need, NEREO 3 provides different solutions and configurations designed for each user.

Paramètre

Face au même besoin, NEREO 3 propose différentes solutions et configurations conçues pour chaque utilisateur.





Meeting

Big decisions require spaces according to needs at the height of the circumstances. Large tables, elegant and functional.

Réunion

Les grandes décisions nécessitent des espaces en fonction des besoins à la hauteur des circonstances. Grandes tables, élégantes et fonctionnelles.

Reunión

Grandes decisiones requieren espacios acorde a necesidades a la altura de las circunstancias. Grandes mesas, elegantes y funcionales.

Versatilidad

La versatilidad de la serie NEREO 3 permite encontrar la solución a la necesidad de cada puesto de trabajo, de su configuración, para que estas cumplan los objetivos marcados.



Versatility

The versatility of the NEREO 3 series allows finding the solution to the needs of each job, its configuration so that they meet the objectives set.

Polyvalence

La polyvalence de la série NEREO 3 permet de trouver la solution aux besoins de chaque travail, sa configuration afin qu'ils répondent aux objectifs fixés.





Personalidad de líneas puras

Sin perder de vista la funcionalidad, no podemos olvidarnos del diseño, el ADN de Ismobel, piezas creadas para dar carácter a los espacios, para vestirlos y para brillar con luz propia.



Clean lined perso-nality

Without losing sight of functionality, we cannot forget about design, Ismobel's DNA, pieces created to give spaces character, to dress them up and to shine with their own light.

Personnalité épu-rée

Sans perdre de vue la fonctionnalité, nous ne pouvons pas oublier le design, l'ADN d'Ismobel, des pièces créées pour donner du caractère aux espaces, les habiller et les faire briller de leur propre lumière.



Arquitectura funcional

Geometrías que resuelven las funcionalidades que necesitas, objetos, libros, tus cosas de cada día que acaban encontrando su sitio, su espacio.

Functional architecture

Geometries that solve the functionalities you need, objects, books, your everyday things that end up finding their place, their space.

Architecture fonctionnelle

Des géométries qui résolvent les fonctionnalités dont vous avez besoin, des objets, des livres, vos objets du quotidien qui finissent par trouver leur place, leur espace.





Coffee Tables

No todo es trabajar, una pausa, un momento de descanso o de encuentro, NEREO 3 se adapta al concepto Contract con estas piezas que abre las puertas a espacios destinados al hogar, hotel...

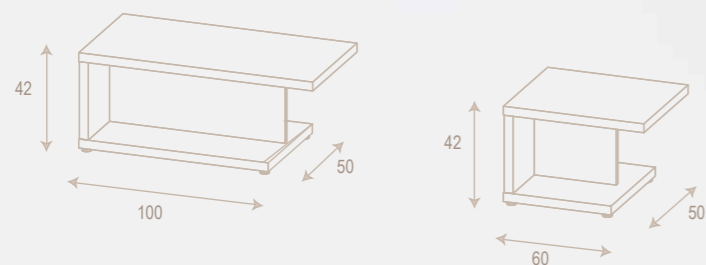

Not everything is work, a break, a moment of rest or meeting, NEREO 3 adapts to the Contract concept with these pieces that open the doors to spaces for the home, hotel...

Tout n'est pas travail, pau-se, moment de repos ou de rencontre, NEREO 3 s'adapte au concept Contract avec ces pièces qui ouvrent les portes d'espaces pour la maison, l'hôtel...

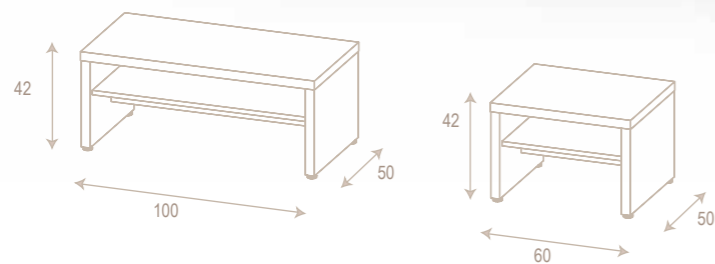

Acabados

Los colores de este catálogo son orientativos, la percepción de los mismos puede variar respecto al original.

The colours of this catalogue are reference, the perception of the same can vary with respect to the original one.

Les couleurs figurant sur le catalogue sont indicatifs, ils peuvent varier para rapport à l'original.

Finishings / Finitions

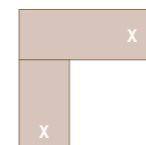

ENCIMERAS Y COSTADOS
Countertops and Sides
Comptoirs et côtés

X = 40mm



ACABADOS VERTICALES
Vertical Finishes
Finitions verticales

X = 19mm

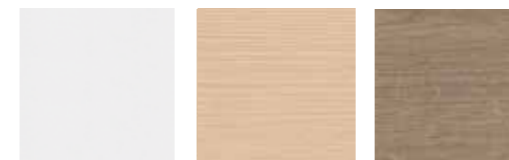

BLANCO
WHITE / BLANC

ROBLE
OAK / POIRIER

BACO
BACO / BACO



NEGRO
BLACK / NOIR

GRAFITO
GRAPHITE / ANTHRACITE

GRIS
GREY / GRIS

ALUMINIO
ALUMINIUM / ALUMINIUM

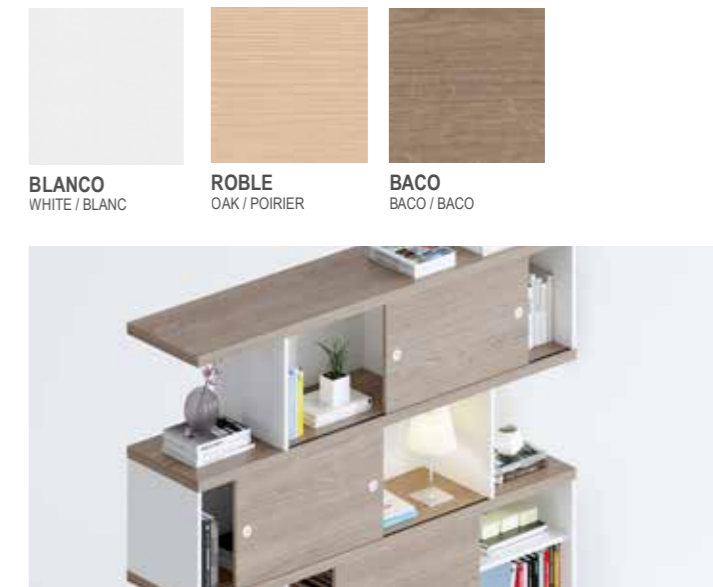

Estanterías

Shelves / Des Étagères

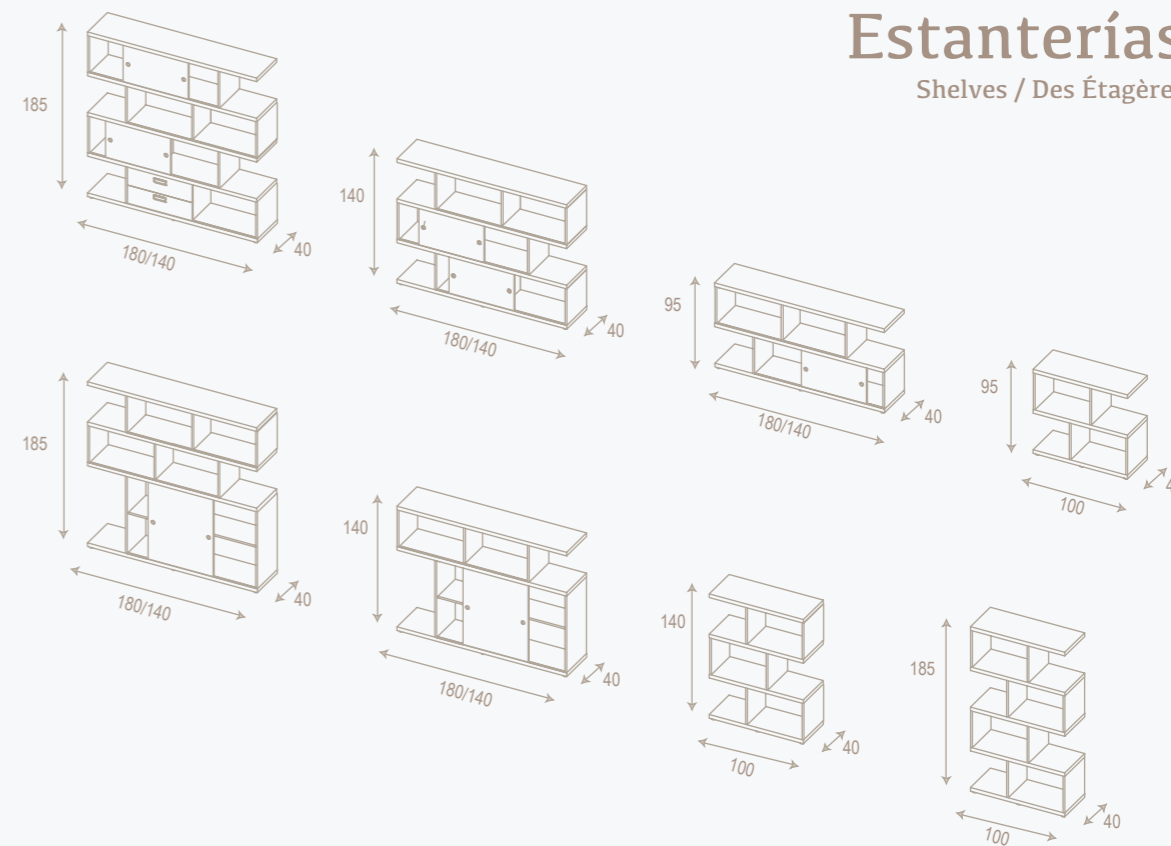



BIBLIOTECAS Y DIVISORIAS

LIBRARIES AND DIVIDERS / BIBLIOTHÈQUES ET SÉPARATEURS

226 BIBLOS

246 horus

270 Panel



ISMOBEL

BIBLOS

BIBLIOTECAS

Designed by
SIGFRIDO BILBAO





Cada ambiente es diferente, el uso, el espacio, la percepción. BIBLOS dispone de una gama de materiales que le permite adaptarse a esos espacios y transmitir las sensaciones en lugares de estudio, formación, en definitiva en lugares de inspiración y concentración..

Cerezo, roble, haya... como texturas de la naturaleza nos acerca a ella, nos transmite su calidez y autenticidad.















SEÑALIZACIÓN Y APOYALIBROS
Signaling and bookholder / Signaletique et serres-livres



NIVELADOR DE ESTANTERÍA
Shelf leveller / Vérin de réglage niveau



RUEDAS CARRO
Trolley's rollers / Roulettes chariot



LÁMPARA
Lamp / Éclairage



SOPORTE CPU
CPU holder / Support UC



AMARRE A PARED
Wall fixer / Crochet mural



DOBLE ESTANTE
Double shlef / Double tablette



ESTANTE INCLINADO REVISTERO
Magazine shelf / Tablette présentoir inclinée



DOBLE ESTANTE CD Y LIBROS PEQUEÑOS
Double shlef for CD and small books
Double Tablette gradin

ACABADOS TAPA LATERAL / Side panel finishes / Finitions panneaux latéraux



CEREZO
Cherry / Mèrisier



ROBLE
Oak / Poirier



HAYA
Beech / Hêtre



BACO
Baco / Baco



ARCE
Maple / Erable



METACRILATO
Metacrylate / Métacrylate



NEGRO
Black / Noir



GRAFITO
Graphite / Anthracite



GRIS
Grey / Gris



BLANCO
White / Blanc



ALUMINIO
Aluminium / Aluminium

ACABADOS METÁLICOS / Metal Finishing / Metal Finitions



NEGRO (*)
BLACK / NOIR



ALUMINIO
ALUMINIUM / ALUMINIUM

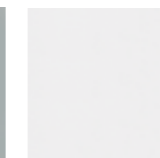

BLANCO
WHITE / BLANC

(*) NO STANDAR / Consulter
NON-STANDARD / Consult
NON STANDARD / Consulter



CARRO INFORMÁTICO RUEDAS
Computer trolley / Chariot informatique



ESTANTERÍA FIJA
Fixed shelf / Étagère fixe



UNIÓN ESTANTERÍAS
Shelves joining / Union d'assemblage de modules



PERCHERO
Rack / Porte chapeaux

LATERALES
Sides / Latéraux

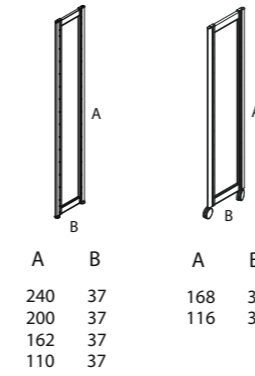

ESTANTES
Shelves / Tablettes

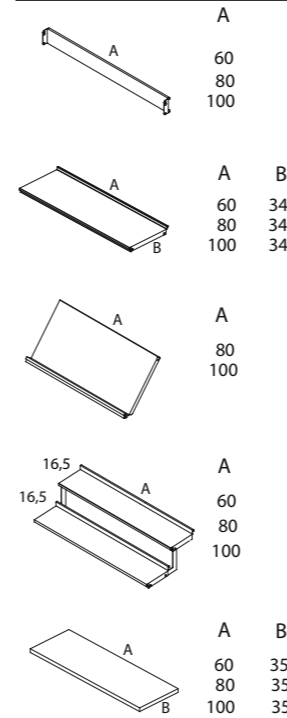

ACCESORIOS
Accessories / Accessoires

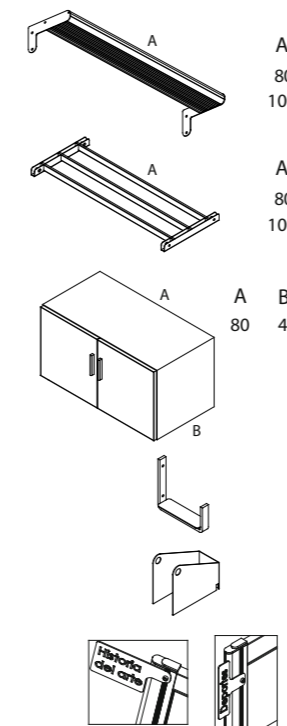

MESAS
Desks / Bureaux

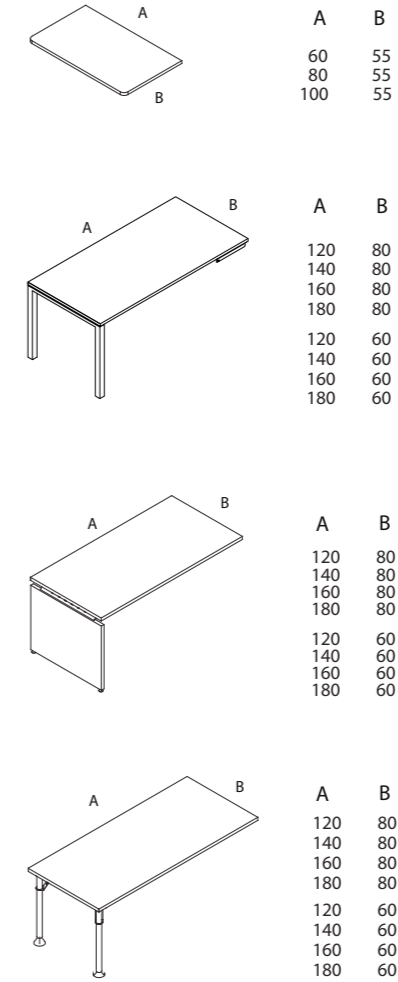

MESAS FO
L-shaped desks / Bureaux compacts

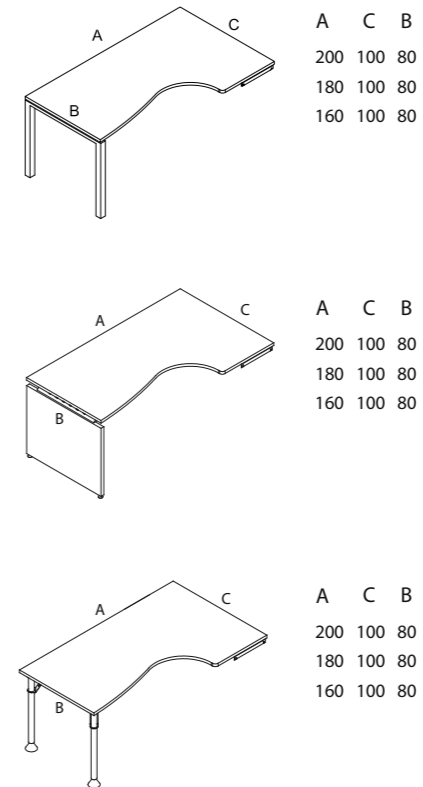

EJEMPLOS DE MONTAJE
Assembling samples / Exemples d'assemblage

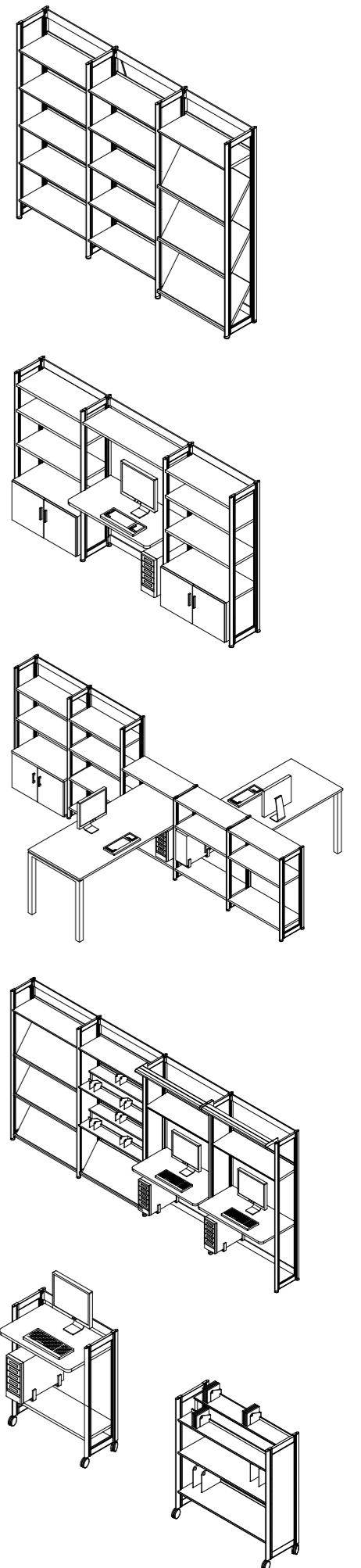

horus

BIOMBOS

Designed by
SIGFRIDO BILBAO





HORUS

BIOMBOS

Design by: SIGFRIDO BILBAO

HORUS / BIOMBOS
UNA SOLUCIÓN VERSÁTIL Y PRÁCTICA PARA DIVIDIR UN ESPACIO Y CREAR ÁREAS INDEPENDIENTES DENTRO DE UN MISMO ENTORNO.

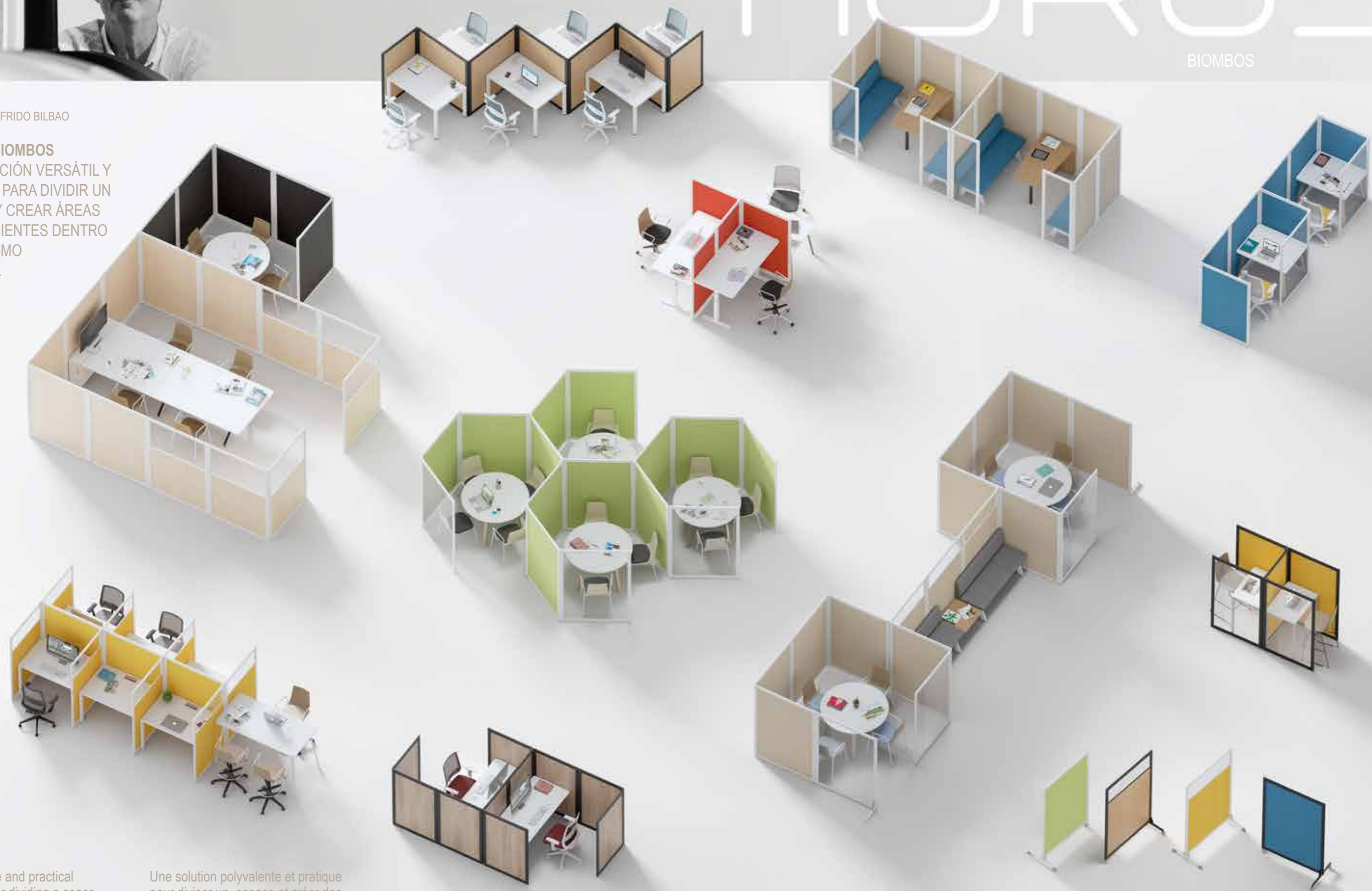

A versatile and practical solution for dividing a space and creating independent areas within the same around.

Une solution polyvalente et pratique pour diviser un espace et créer des zones indépendantes dans le même autour.

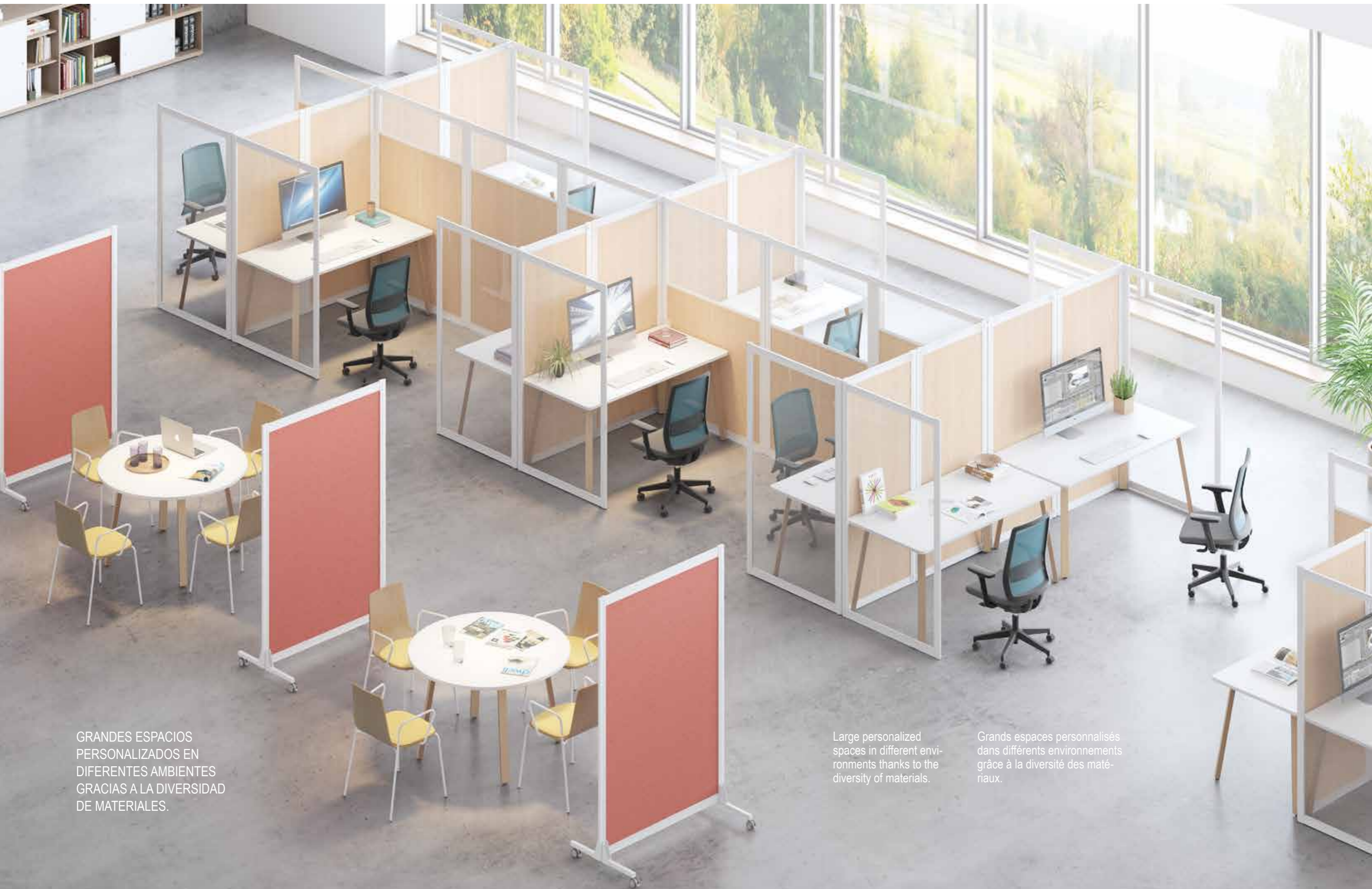

GRANDES ESPACIOS
PERSONALIZADOS EN
DIFERENTES AMBIENTES
GRACIAS A LA DIVERSIDAD
DE MATERIALES.

Large personalized
spaces in different envi-
ronments thanks to the
diversity of materials.

Grands espaces personnalisés
dans différents environnements
grâce à la diversité des maté-
riaux.





Closeness and discretion,
two concepts that live in
harmony.

Proximité et discrétion,
deux concepts qui
vivent en harmonie.



CERCANIA Y DISCRECIÓN,
DOS CONCEPTOS QUE
CONVIVEN EN ARMONÍA.





SIN MOLESTAR,
TOMARSE UN DESCANSO SE
COMPAGINA CON EL TRABAJO
DEL RESTO DEL EQUIPO.
LA ACÚSTICA COMO UN
VALOR INDISPENSABLE.



Dont disturb, taking a break is
combined with the work of the
rest of the team. Acoustics as
an essential value.

Ne pas deranger, prendre une pau-
se est combiné au travail du reste
de l'équipe. L'acoustique comme
valeur essentielle.







A GUSTO DEL CONSUMIDOR.
 ES UNA REALIDAD LA DIVERSIDAD
 DE TIPOS DE ESPACIOS Y DEL
 TAMAÑO DE ESTOS, **HORUS** SE
 ADAPTA A LAS NECESIDADES
 DEL TRABAJO Y SOBRE TODO
 DEL ESPACIO.

To like the consumer.
 The diversity of types of spaces
 and their sizes is a reality, **HORUS**
 adapts to the needs of the work and
 above all of the space.

Aimer le consommateur.
 La diversité des types d'espaces
 et de leurs tailles est une réalité,
HORUS s'adapte aux besoins du
 travail et surtout de l'espace.



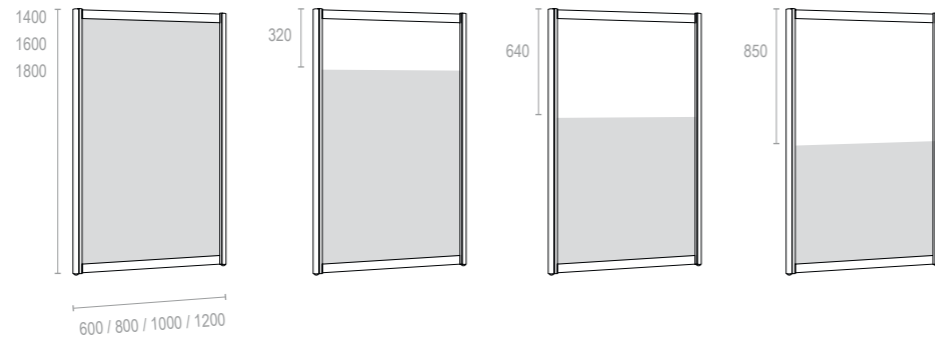

MELAMINA
MELAMINE
MÉLAMINA



TAPIZADO SOBRE PET (Acústico)
UPHOLSTERED ON PET (Acoustic)
REMOURRÉ SUR PET (Acoustique)

TAPIZADO SOBRE MELAMINA
UPHOLSTERED ON MELAMINE
REMOURRÉ SUR MÉLAMINE

MIXTO TAPIZADO SOBRE MELAMINA /
METACRILATO
MIXED UPHOLSTERED ON MELAMINE /
METHACRYLATE
REMOURRAGE MIXTE SUR MÉLAMINE /
MÉTHACRYLATE

MIXTO TAPIZADO SOBRE MELAMINA /
METACRILATO
MIXED UPHOLSTERED ON MELAMINE /
METHACRYLATE
REMOURRAGE MIXTE SUR
MÉLAMINE / MÉTHACRYLATE



MELAMINA / METACRILATO
MELAMINE / METHACRYLATE
MÉLAMINE / MÉTHACRYLATE

MELAMINA / METACRILATO
MELAMINE / METHACRYLATE
MÉLAMINE / MÉTHACRYLATE

MELAMINA / MELAMINA
MELAMINE / MELAMINE
MÉLAMINE / MÉLAMINE

MELAMINA / MELAMINA
MELAMINE / MELAMINE
MÉLAMINE / MÉLAMINE



MIXTO TAPIZADO SOBRE
MELAMINA / MELAMINA
MIXED UPHOLSTERED ON
MELAMINE / MELAMINE
REMOURRAGE MIXTE SUR
MELAMINE / MÉLAMINE

MIXTO TAPIZADO SOBRE
MELAMINA / MELAMINA
MIXED UPHOLSTERED ON
MELAMINE / MELAMINE
REMOURRAGE MIXTE SUR
MELAMINE / MÉLAMINE

MIXTO MELAMINA / TAPIZADO
SOBRE MELAMINA
MIXED MELAMINE / UPHOLSTERED
ON MELAMINE
MÉLANGE MIXTE / REMOURRÉ
SUR MÉLAMINE

MIXTO MELAMINA / TAPIZADO
SOBRE MELAMINA
MIXED MELAMINE / UPHOLSTERED
ON MELAMINE
MÉLANGE MIXTE / REMOURRÉ
SUR MÉLAMINE



METACRILATO
METHACRYLATE
MÉTHACRYLATE

PIZARRA MAGNÉTICA (1 o 2 caras)
MAGNETIC BOARD (1 or 2 sides)
TABLEAU MAGNÉTIQUE (1 ou 2 faces)

MELAMINA / PIZARRA MAGNÉTICA (1 o 2 caras)
MELAMINA / MAGNETIC BOARD (1 or 2 sides)
MÉLAMINA / TABLEAU MAGNÉTIQUE (1 ou 2 faces)



MIXTO TAPIZADO
MIXED UPHOLSTERED
REMOURRAGE MIXTE

MIXTO TAPIZADO
MIXED UPHOLSTERED
REMOURRAGE MIXTE



MIXTO TAPIZADO MELAMINA /
PIZARRA MAGNÉTICA (1 o 2 caras)
MIXED MELAMINE /
MAGNETIC BOARD (1 or 2 sides)
MÉLANGE MIXTE/
TABLEAU MAGNÉTIQUE (1 ou 2 faces)

UNIONES

CONNECTIONS / CONNEXIONS



UNIÓN LINEA / 180°
LINE CONNECTION 180°
CONNEXION LIGNE 180°



UNIÓN 90° (2 VÍAS)
CONNECTION 90° (2 WAY)
CONNEXION 90° (2 VOIES)



UNIÓN 90° (3 VÍAS)
CONNECTION 90° (3 WAY)
CONNEXION 90° (3 VOIES)



UNIÓN 90° (4 VÍAS)
CONNECTION 90° (4 WAY)
CONNEXION 90° (4 VOIES)



UNIÓN 120° (2 VÍAS)
CONNECTION 120° (2 WAY)
CONNEXION 120° (2 VOIES)



UNIÓN 120° (3 VÍAS)
CONNECTION 120° (3 WAY)
CONNEXION 120° (3 VOIES)

COMPLEMENTOS

ACCESSORIES / ACCESSOIRES



PATA DOBLE
DOUBLE LEG
PIED DOUBLE



PATA DOBLE RUEDAS
DOUBLE LEG WITH CASTORS
PIED DOUBLE AVEC ROUES



COLGADOR
HANGER
CINTRE



PATA INDIVIDUAL
SINGLE LEG
JAMBE UNIQUE



PATA DOBLE CON RUEDAS + RUEDA
DOUBLE LEG WITH CASTORS + CASTOR
DOUBLE PIED AVEC ROUES + ROUE



BANDEJA
TRAY
PLATEAU

ACABADOS

FINISHINGS / FINITIONS

MELAMINAS

MELAMINE / MÉLAMINES

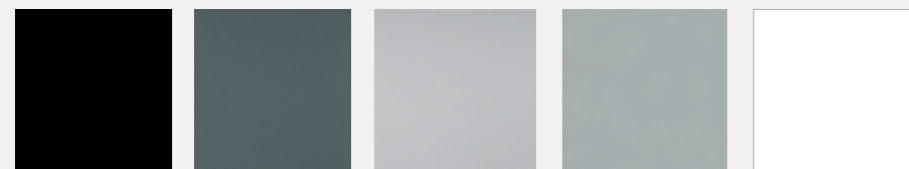

NEGRO
BLACK
NOIR

GRAFITO
GRAPHITE
ANTHRACITE

GRIS
GREY
GRIS

ALUMINIO
ALUMINIUM
ALUMINIUM

BLANCO
WHITE
BLANC

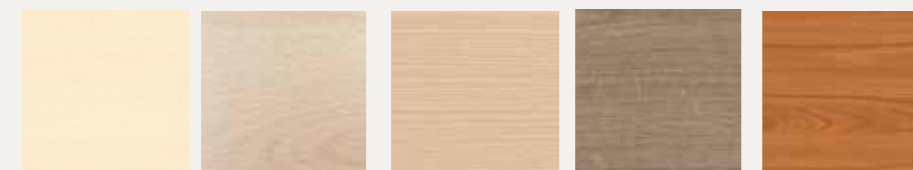

ARCE
MAPLE
ERABLE

HAYA
BEECH
HÊTRE

ROBLE
OAK
POIRIER

BACO
BACO
BACO

CEREZO
CHERRY
MÉRISIE

METÁLICOS

METAL PARTS / MÉTALLIQUES

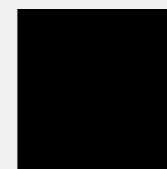

NEGRO
BLACK
NOIR

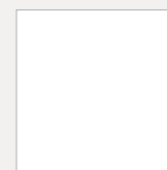

BLANCO
WHITE
BLANC

TAPICERÍAS / BASIC F.R.

UPHOLSTERY / TAPISSERIES

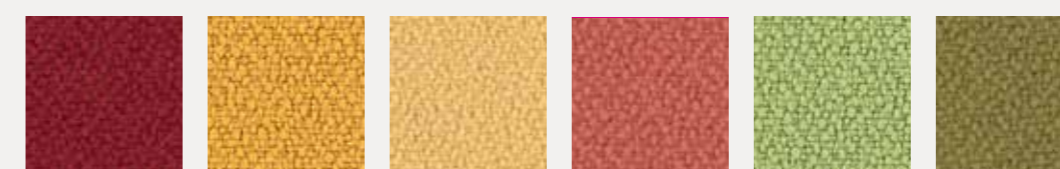

106

088

755

462

098

077



055

084

170

315

108

009

METACRILATO TRASPARENTE

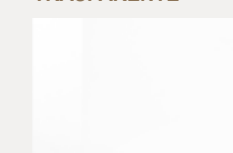

TRANSPARENT METHACRYLATE
METHACRYLATE TRANSPARENT

PIZARRA MAGNÉTICA BRILLO

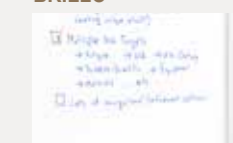

GLOSS MAGNETIC WHITEBOARD
TABLEAU BLANC MAGNÉTIQUE
BRILLANT

PANEL

DIVISORIAS

Designed by
SIGFRIDO BILBAO

IS
ISMOBEL





ATENCIÓN Y PROTECCIÓN

Mantener el contacto visual pero con el menor contacto directo posible con el público, con nuestro cliente, con nuestros compañeros sin perder el estilo y el diseño.
Composiciones personalizables y perfectamente integradas en el entorno. Elementos separadores que se anclan perfectamente a los diferentes modelos de mesas.



Maintain eye contact and maintain distances with the public, with our client, with our colleagues without losing style and design. Customizable compositions and perfectly integrated into the environment. Screens that are perfectly anchored to the different models of tables

Maintenez un contact visuel et maintenez des distances avec le public, avec notre client, avec nos collègues sans perdre de style et de design. Compositions personnalisables et parfaitement intégrées à l'environnement. Des éléments de séparation parfaitement ancrés aux différents modèles de tables.

Hay momentos que la privacidad es determinante. Estas a su vez tienen su particularidad en su funcionalidad. Cada una de ellas necesita una solución personalizada y PANEL resuelve esta necesidad. Altos, bajos, individuales, colectivos...



There are times when privacy is decisive. These in turn have their particularity in their functionality. Each of them needs a personalized solution and PANEL solves this need. High, low, individual, collective ...

Il y a des moments où la vie privée est décisive. Ceux-ci ont à leur tour leur particularité dans leur fonctionnalité. Chacun d'eux a besoin d'une solution personnalisée et PANEL répond à ce besoin. Haut, bas, individuel, collectif ...





ACABADOS FINISHINGS / FINITIONS



METACRILATOS
METHACRYLATE
METHACRYLATE

TRASPARENTE
TRANSPARENT / TRANSPARENT



NEGRO
BLACK / NOIR



GRAFITO
GRAPHITE / ANTHRACITE



GRIS
GREY / GRIS



ALUMINIO
ALUMINIUM / ALUMINIUM

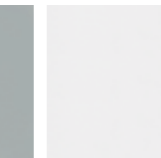

BLANCO
WHITE / BLANC

MELAMINAS
MELAMINE
MÉLAMINES



ARCE
MAPLE / ERABLE



BACO
BACO / BACO



HAYA
BEECH / HÊTRE



ROBLE
OAK / POIRIER



CEREZO
CHERRY / MÉRISIE



AZUL
BLEU / BLEU



NUDE
NUDE / NUDE



VERDE
GREEN / VERT



AMARILLO
YELLOW / JAUNE



TERRACOTA
TERRACOTTA / TERRE CUITE

ELEMENTOS VERTICALES
VERTICAL ELEMENTS
ÉLÉMENTS VERTICAUX

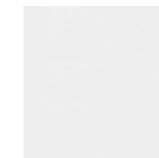

BLANCO
WHITE / BLANC

ACABADOS METÁLICOS
METAL FINISHING
METAL FINITIONS

Los colores de este catálogo son orientativos, la percepción de los mismos puede variar respecto al original.

The colours of this catalogue are reference, the perception of the same can vary with respect to the original one.

Les couleurs figurant sur le catalogue sont indicatifs ils peuvent varier para rapport à l'original.



almacenaje

STORAGE / STOCKAGE



ALMACENAJE





ORDEN, ORGANIZACIÓN,
DISCRECIÓN, DIVERSIDAD.

Las necesidades particulares de cada usuario, de cada momento, requiere soluciones que se adapten a cada una de ellas, pero teniendo en cuenta la privacidad, la conectividad y la integración en cada una de las instalaciones.

ORDEN, ORGANIZACIÓN,
DISCRECIÓN, DIVERSIDAD.

Las necesidades particulares de cada usuario, de cada momento, requiere soluciones que se adapten a cada una de ellas, pero teniendo en cuenta la privacidad, la conectividad y la integración en cada una de las instalaciones.



ORDEN, ORGANIZACIÓN,
DISCRECIÓN, DIVERSIDAD.

Las necesidades particulares de cada usuario, de cada momento, requiere soluciones que se adapten a cada una de ellas, pero teniendo en cuenta la privacidad, la conectividad y la integración en cada una de las instalaciones.





ACABADOS FINISHES / FINITIONS

Los colores de este catálogo son orientativos, la percepción de los mismos puede variar respecto al original.

The colours of this catalogue are reference, the perception of the same can vary with respect to the original one.

Les couleurs figurant sur le catalogue sont indicatifs, ils peuvent varier para rapport à l'original.

ELEMENTOS VERTICALES VERTICAL ELEMENTS / ÉLÉMENTS VERTICAUX



AZUL
BLE
BLEU

NUDE
NUDE
NUDE

VERDE
GREEN
VERT



AMARILLO
YELLOW
JAUNE

TERRACOTA
TERRACOTTA
TERRE CUITE

ACABADOS GENERALES GENERAL FINISHES / FINITIONS GÉNÉRALES



NEGRO
BLACK
NOIR

GRAFITO
GRAPHITE
ANTHRACITE

GRIS
GREY
GRIS

ALUMINIO
ALUMINIUM
ALUMINIUM

BLANCO
WHITE
BLANC



ARCDE
MAPLE
ERABLE

BACO
BACO
BACO

HAYA
BEECH
HÊTRE

ROBLE
OAK
POIRIER

CEREZO
CHERRY
MÉRISIE



SIGFRIDO BILBAO

LA IMPORTANCIA DE LA EXPERIENCIA DE USUARIO.

Para ISMOBEL, el diseño ha sido la columna vertebral de todo el desarrollo de producto, un diseño basada en la experiencia de usuario, en la experiencia de años en el sector y en la capacidad de evolucionar el producto final para la satisfacción del usuario. Los medios técnicos y humanos son fundamentales para llegar a ese objetivo.

Es por eso que tanto el DEPARTAMENTO DE DISEÑO como la colaboración con diseñadores de dilatada experiencia como SIGFRIDO BILBAO, nos permite ofrecer un catálogo completo de soluciones para las diferentes necesidades del mercado.



DEPARTAMENTO DISEÑO ISMOBEL

Para ISMOBEL, el diseño ha sido la columna vertebral de todo el desarrollo de producto, un diseño basada en la experiencia de usuario, en la experiencia de años en el sector y en la capacidad de evolucionar el producto final para la satisfacción del usuario.

Los medios técnicos y humanos son fundamentales para llegar a ese objetivo.

Es por eso que tanto el DEPARTAMENTO DE DISEÑO como la colaboración con diseñadores de dilatada experiencia como SIGFRIDO BILBAO, nos permite ofrecer un catálogo completo de soluciones para las diferentes necesidades del mercado.

Para ISMOBEL, el diseño ha sido la columna vertebral de todo el desarrollo de producto, un diseño basada en la experiencia de usuario, en la experiencia de años en el sector y en la capacidad de evolucionar el producto final para la satisfacción del usuario.

Los medios técnicos y humanos son fundamentales para llegar a ese objetivo.

Es por eso que tanto el DEPARTAMENTO DE DISEÑO como la colaboración con diseñadores de dilatada experiencia como SIGFRIDO BILBAO, nos permite ofrecer un catálogo completo de soluciones para las diferentes necesidades del mercado.

THE SOLU- TION



Grupo Imobel

ESTAMOS PREPARADOS
WE ARE READY / NOUS SOMMES PRÊTS

AIDIMME 
INSTITUTO TECNOLÓGICO
METALMECÁNICO, MUEBLE, MADERA, EMBALAJE Y AFINES



ECODISEÑO ISO 14006:2011

THE SOLUTION



Grupo Ismobel

Polígono La Portalada II
C/ Cordonera 5
26006 LOGROÑO (La Rioja)
T. +34 941 230 752 / F. +34 941 248 977
ismobel@ismobel.com

ismobel.com

